

Onka®

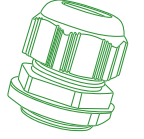
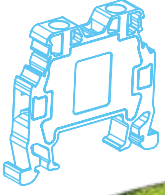
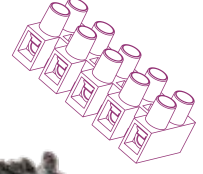
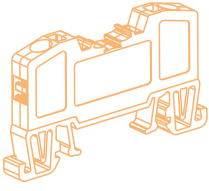
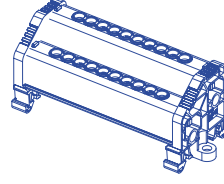
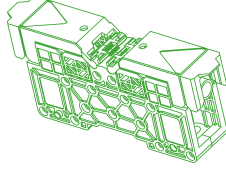

2023

TEDARİKÇİNİN EL KİTABI

www.Onka.com.tr

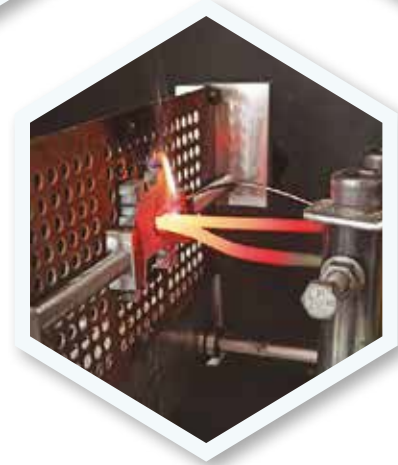
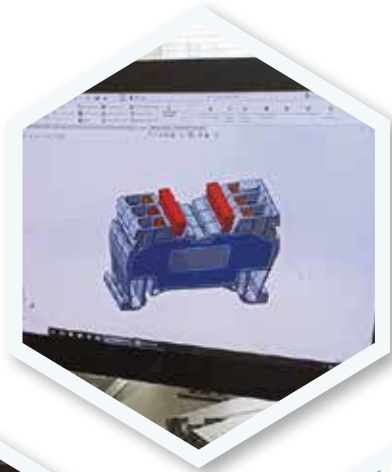

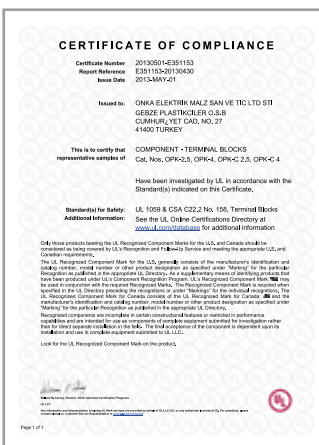

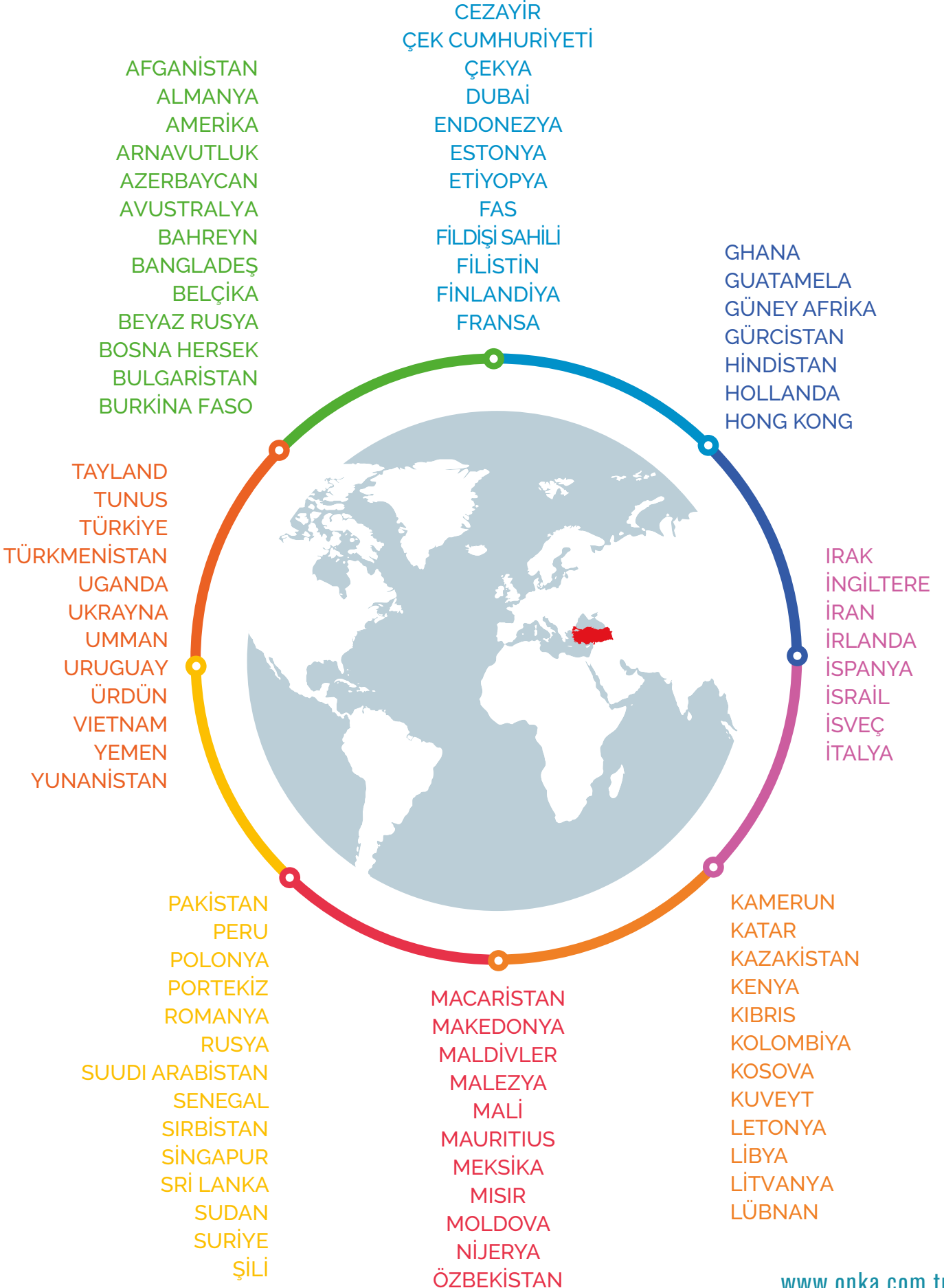

Vida Bağlantılı Ray Klemensler **6**

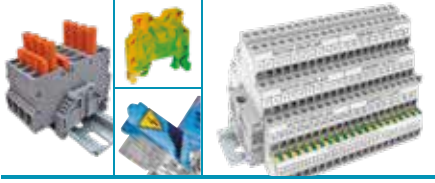

Montaj Rayları **74**



Kablo Kanalları **118**

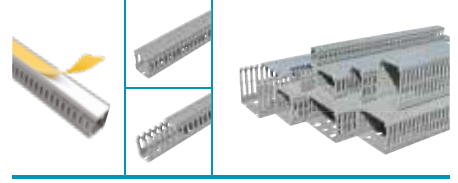

Yay Bağlantılı Ray Klemensler **28**

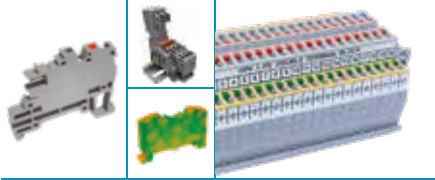

Sıkmalı Kablo Pabuçları **89**



Kablo Uçları **119**



Mini Yay Bağlantılı Ray Klemensler **46**

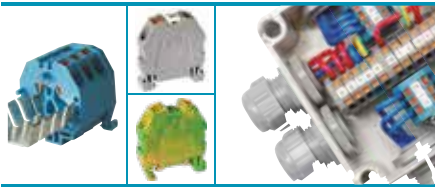

Sıra Klemensler **94**



Kablo Bağları ve Aksesuarları **131**

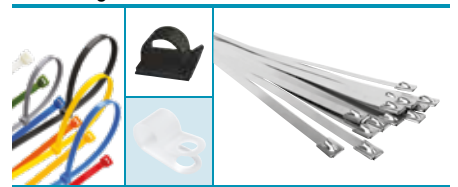

Markalama Sistemleri **52**



Kablo ve Pano Aksesuarları **105**

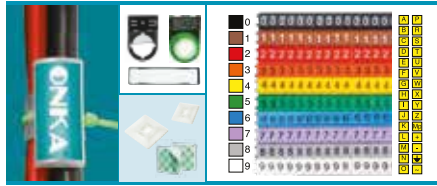

İzolatörler **151**



Dağıtıcı Üniteler **62**



Poliamid Kablo Rakorlar **111**



Makaronlar **182**

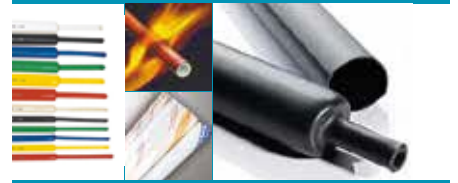

W Otomat Baraları **68**

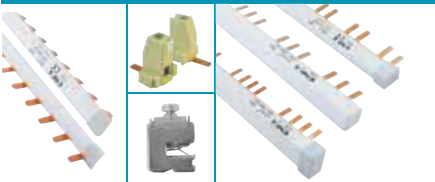

Ray Tipi Prizler **117**



Pano Aydınlatma **188**



Onka®

11 mm
Şerit Etiket
Takılabilir.

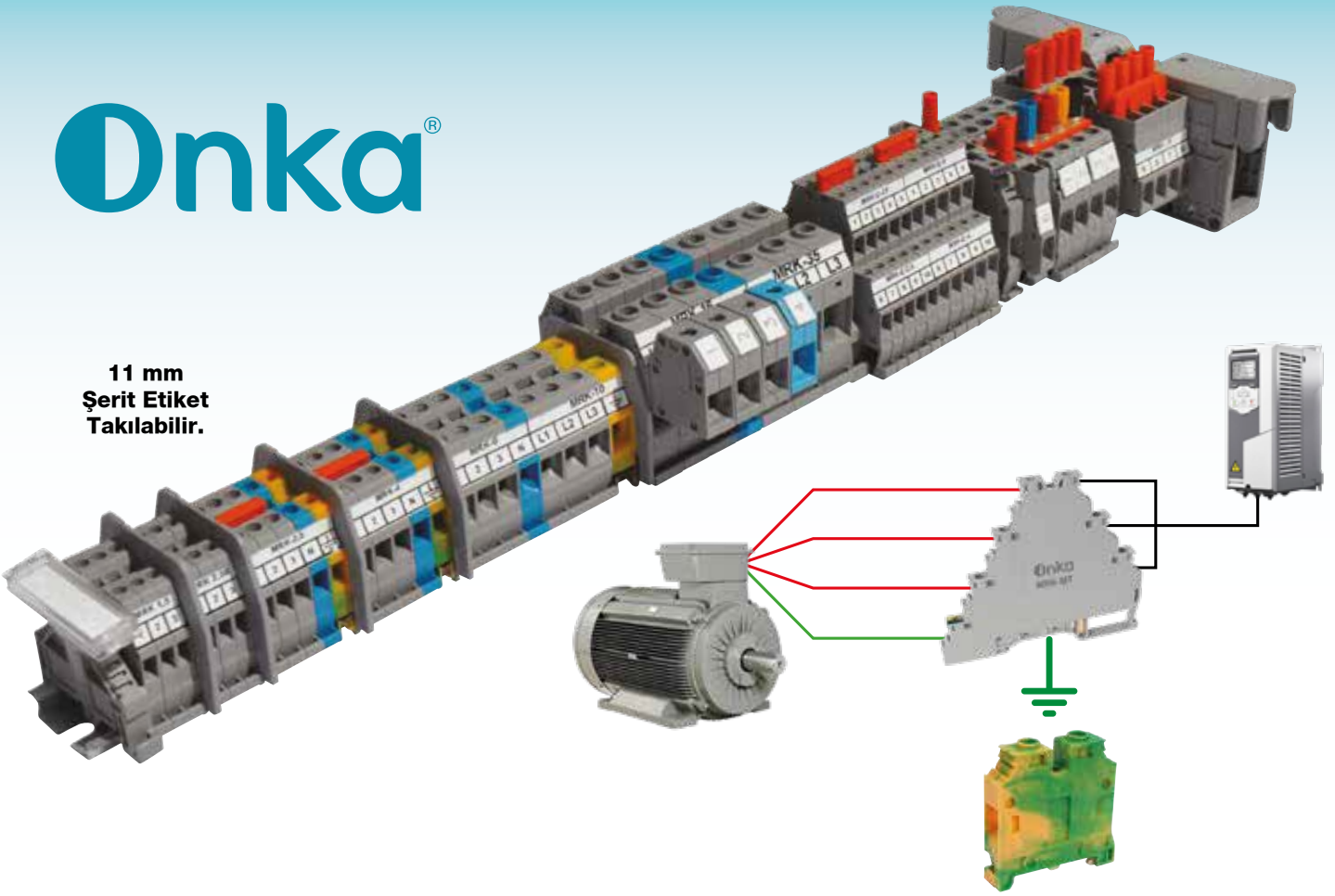

MRK SERİSİ

Vida Bağlantılı Ray Klemensler

- Nihayet plakası gerektirmez. (Her iki tarafı kapalı)
- Daha iyi bir izolasyon ve maliyet avantajı sağlar.
- Simetrik. (Her iki yönde raya monte edilebilir)
- 0,25 mm² den 240 mm² kablo kesitine kadar montaj imkanı sağlar.
- Renk Kodlama / Dekafix / Şerit Etiketleme olanaklarıyla evrensel markalama avantajları
- Çift yönlü köprüleme imkanı.
- 1,5 mm² den 10 mm² ye kadar izoleli tarak köprü kullanılabilir.
- Vida sistemi 1,5 mm² den 35 mm² ye kadar düz başlı, 50 mm² ve sonraki kesitlerde alyan başlıdır.
- Ergonomik ve kompakt tasarımlara imkan sağlayarak montaj alanını minimize eder.
- MRK Serisi 1.5-2.5-4-6-10-16-25-35-50-70-95-120 mm² kesitlerde üretilmektedir.
- Klemens içerisindeki bakır bara ve kovan iç çeperinde yapılan setler, montajı tamamlanan iletken üzerinde maksimum güvenli bağlantı sağlar.
- MRK 16, 25 ve 35'in köprüleme sistemi vidalı üst köprüdür.



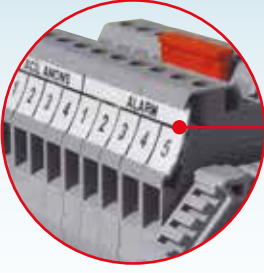

Yeni MRK Serisinde 1.5 mm² den 35 mm² kesite kadar şerit etiketleme sistemi uygulanabilir.

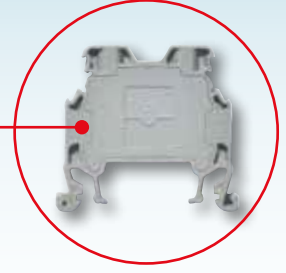

Ana gövde tek parça ve nihayet plakası içine gömülü olarak üretilmiştir.



MRK Serisinde 1.5 mm² den 10 mm² ye kadar geçmeli üst köprü sistemi kullanılmıştır.

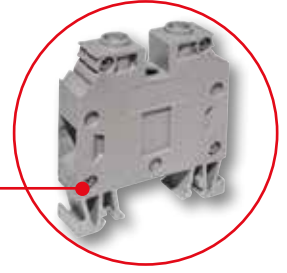

Yeni MRK 16 ve 35'te klemens gövdesi ve kapağı birbirine 4 adet çelik vida ile sabitlenmiştir.

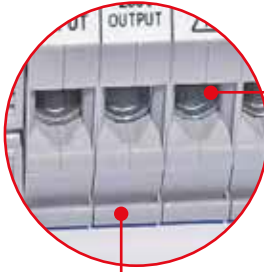

MRK 6-10-16 ve 35'in kovan sisteminin alt kısmındaki U formu sayesinde kovanın kabloya daha fazla teması sağlanmıştır.

MRK 16 ve 35'in raya montaj ayaklarının gövde genişliğinde olması sayesinde ray üzerinde daha geniş ve rijit kavrama, güvenli ve sağlam montaj imkanı.



MONTAJ RAYI ÇEŞİTLERİ

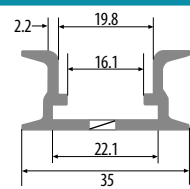
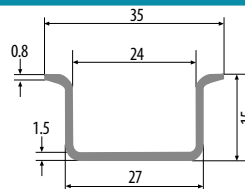
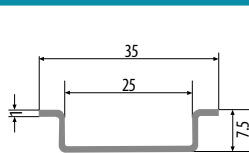

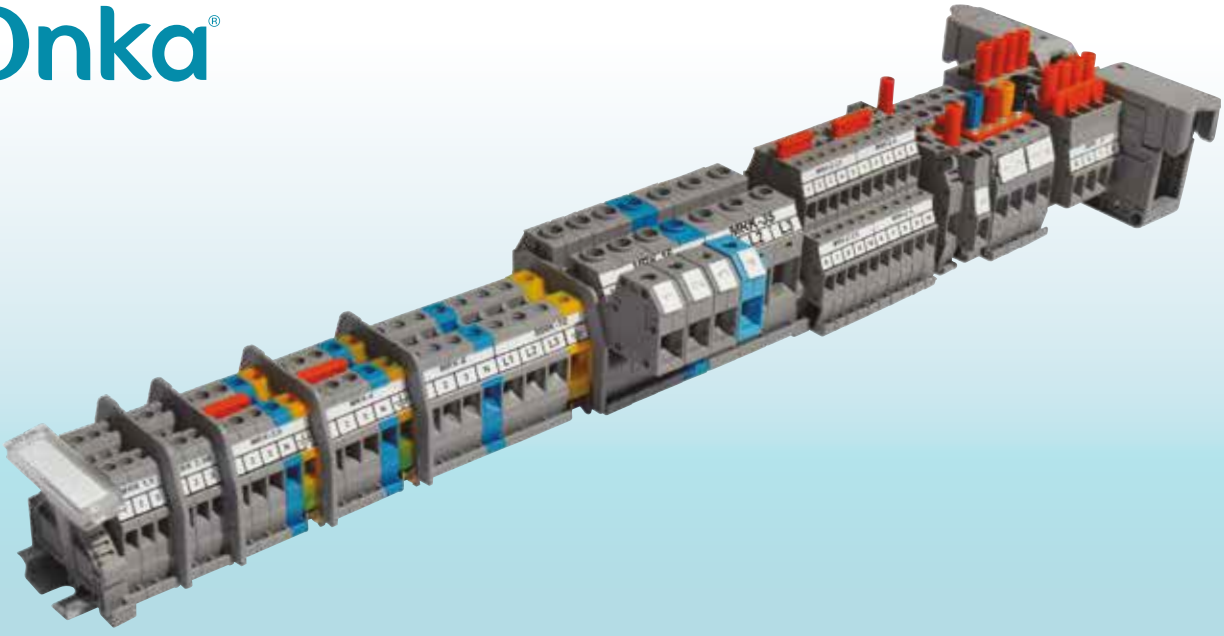







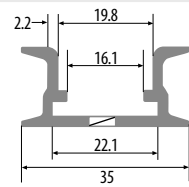
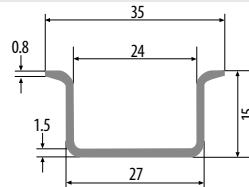
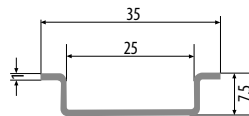







































MRK SERİSİ VİDA BAĞLANTILI RAY KLEMENSLER (HER İKİ TARAFI KAPALI SİSTEM)

CİNSİ	GERİLİM / AKIM (V/A)	KUTU ADEDİ	RENK	YENİ KOD	ESKİ KOD	ADET (t)	YENİ KOD (V0)	ESKİ KOD (V0)	ADET (V0) (t)		
MRK 1,5 mm ²	750 V / 17,5 A	100		1010001	ONKA-1001	10,24			10,86		
				1010002	ONKA-1002					1010151	ONKA-0752
				1010003	ONKA-1003						
				1010004	ONKA-1004						
				1010005	ONKA-1005						
				1010006	ONKA-1006						
				1010007	ONKA-1007						
				1010008	ONKA-1008						
				1010009	ONKA-1009					1010152	ONKA-0759
MRK 2,5 mm ²	750 V / 24 A	100		1010011	ONKA-1011	11,47			12,38		
				1010012	ONKA-1012					1010153	ONKA-0762
				1010013	ONKA-1013					1010154	ONKA-0763
				1010014	ONKA-1014					1010155	ONKA-0764
				1010015	ONKA-1015					1010156	ONKA-0765
				1010016	ONKA-1016					1010157	ONKA-0766
				1010017	ONKA-1017					1010158	ONKA-0767
				1010018	ONKA-1018					1010159	ONKA-0768
				1010019	ONKA-1019					1010160	ONKA-0769
MRK 4 mm ²	750 V / 32 A	100		1010021	ONKA-1021	13,40			14,49		
				1010022	ONKA-1022					1010162	ONKA-0772
				1010023	ONKA-1023					1010163	ONKA-0773
				1010024	ONKA-1024					1010164	ONKA-0774
				1010025	ONKA-1025					1010165	ONKA-0775
				1010026	ONKA-1026					1010166	ONKA-0776
				1010027	ONKA-1027					1010167	ONKA-0777
				1010028	ONKA-1028						
				1010029	ONKA-1029						

MONTAJ RAYI ÇEŞİTLERİ







MRK SERİSİ VİDA BAĞLANTILI RAY KLEMENSLER (HER İKİ TARAFI KAPALI SİSTEM)

CİNSİ	GERİLİM / AKIM (V/A)	KUTU ADEDİ	RENK	YENİ KOD	ESKİ KOD	ADET (t)	YENİ KOD (V0)	ESKİ KOD (V0)	ADET (V0) (t)
MRK 6 mm ²	750 V / 41 A	100		1010031	ONKA-1031	17,77			18,79
				1010032	ONKA-1032		1010168	ONKA-0782	
				1010033	ONKA-1033		1010169	ONKA-0783	
				1010034	ONKA-1034		1010170	ONKA-0784	
				1010035	ONKA-1035		1010171	ONKA-0785	
				1010036	ONKA-1036		1010172	ONKA-0786	
				1010037	ONKA-1037		1010173	ONKA-0787	
				1010038	ONKA-1038				
				1010039	ONKA-1039				
MRK 10 mm ²	750 V / 57 A	100		1010041	ONKA-1041	22,98			24,29
				1010042	ONKA-1042		1010174	ONKA-0792	
				1010043	ONKA-1043		1010175	ONKA-0793	
				1010044	ONKA-1044		1010176	ONKA-0794	
				1010045	ONKA-1045		1010177	ONKA-0795	
				1010046	ONKA-1046		1010178	ONKA-0796	
				1010047	ONKA-1047		1010179	ONKA-0797	
				1010048	ONKA-1048				
				1010049	ONKA-1049				
MRK 16 mm ²	750 V / 76 A	50		1010051	ONKA-1131	39,43			40,93
				1010052	ONKA-1132		1010209	ONKA-0882	
				1010053	ONKA-1133			ONKA-0883	
				1010054	ONKA-1134			ONKA-0884	
				1010055	ONKA-1135			ONKA-0885	
				1010056	ONKA-1136			ONKA-0886	
				1010057	ONKA-1137			ONKA-0887	
				1010058	ONKA-1138				
				1010059	ONKA-1139				
MRK 25 mm ²	750 V / 101 A	50		1010061	ONKA-0301	47,03			49,79
				1010062	ONKA-0302		1010180	ONKA-0802	
				1010063	ONKA-0303		1010181		
				1010064	ONKA-0304		1010182		
				1010065	ONKA-0305		1010183		
				1010066	ONKA-0306		1010184		
				1010067	ONKA-0307		1010185		
				1010068	ONKA-0308				
				1010069	ONKA-0309				
MRK 35 mm ²	750 V / 125 A	30		1010071	ONKA-1141	56,70			57,98
				1010072	ONKA-1142		1010210	ONKA-0892	
				1010073	ONKA-1143				
				1010074	ONKA-1144				
				1010075	ONKA-1145				
				1010076	ONKA-1146				
				1010077	ONKA-1147				
				1010078	ONKA-1148				
				1010079	ONKA-1149				



 **YÜKSÜKSÜZ**

MRK SERİSİ VİDA BAĞLANTILI RAY KLEMENSLER (HER İKİ TARAFI KAPALI SİSTEM)

CİNSİ	GERİLİM / AKIM (V/A)	KUTU ADEDİ	RENK	YENİ KOD	ESKİ KOD	ADET (t)	YENİ KOD (V0)	ESKİ KOD (V0)	ADET (V0) (t)
MRK 35 mm ² Yüksek Tip 	750 V / 125 A	30		1010081	ONKA-1061	65,90			68,69
				1010082	ONKA-1062		1010186	ONKA-0812	
				1010083	ONKA-1063		1010187	ONKA-0813	
				1010084	ONKA-1064		1010188	ONKA-0814	
				1010085	ONKA-1065		1010189	ONKA-0815	
				1010086	ONKA-1066		1010190	ONKA-0816	
				1010087	ONKA-1067		1010191	ONKA-0817	
				1010088	ONKA-1068		1010192	ONKA-0818	
				1010089	ONKA-1069		1010193	ONKA-0819	
			MRK 50 mm ² 	750 V / 150 A	20			1010091	
	1010092	ONKA-1072				1010194	ONKA-0822		
	1010093	ONKA-1073				1010195	ONKA-0823		
	1010094	ONKA-1074				1010196	ONKA-0824		
	1010095	ONKA-1075				1010197	ONKA-0825		
	1010096	ONKA-1076				1010198	ONKA-0826		
	1010097	ONKA-1077				1010199	ONKA-0827		
	1010098	ONKA-1078				1010200	ONKA-0828		
	1010099	ONKA-1079				1010201	ONKA-0829		
MRK 70 mm ² 	750 V / 192 A	20					1010101	ONKA-1081	222,29
				1010102	ONKA-1082	1010202	ONKA-0832		
				1010103	ONKA-1083				
				1010104	ONKA-1084				
				1010105	ONKA-1085	1010203	ONKA-0835		
				1010106	ONKA-1086				
				1010107	ONKA-1087				
				1010108	ONKA-1088				
				1010109	ONKA-1089				
			MRK 95 mm ² 	1000 V / 232 A	10		1010111	ONKA-1091	
	1010112	ONKA-1092				1010204	ONKA-0842		
	1010113	ONKA-1093							
	1010114	ONKA-1094							
	1010115	ONKA-1095				1010205	ONKA-0845		
	1010116	ONKA-1096							
	1010117	ONKA-1097							
	1010118	ONKA-1098							
	1010119	ONKA-1099							
MRK 120 mm ² 	1000 V / 269 A	10					1010121	ONKA-1101	419,04
				1010122	ONKA-1102	1010206	ONKA-0852		
				1010123	ONKA-1103				
				1010124	ONKA-1104				
				1010125	ONKA-1105				
				1010126	ONKA-1106				
				1010127	ONKA-1107				
				1010128	ONKA-1108				
				1010129	ONKA-1109				

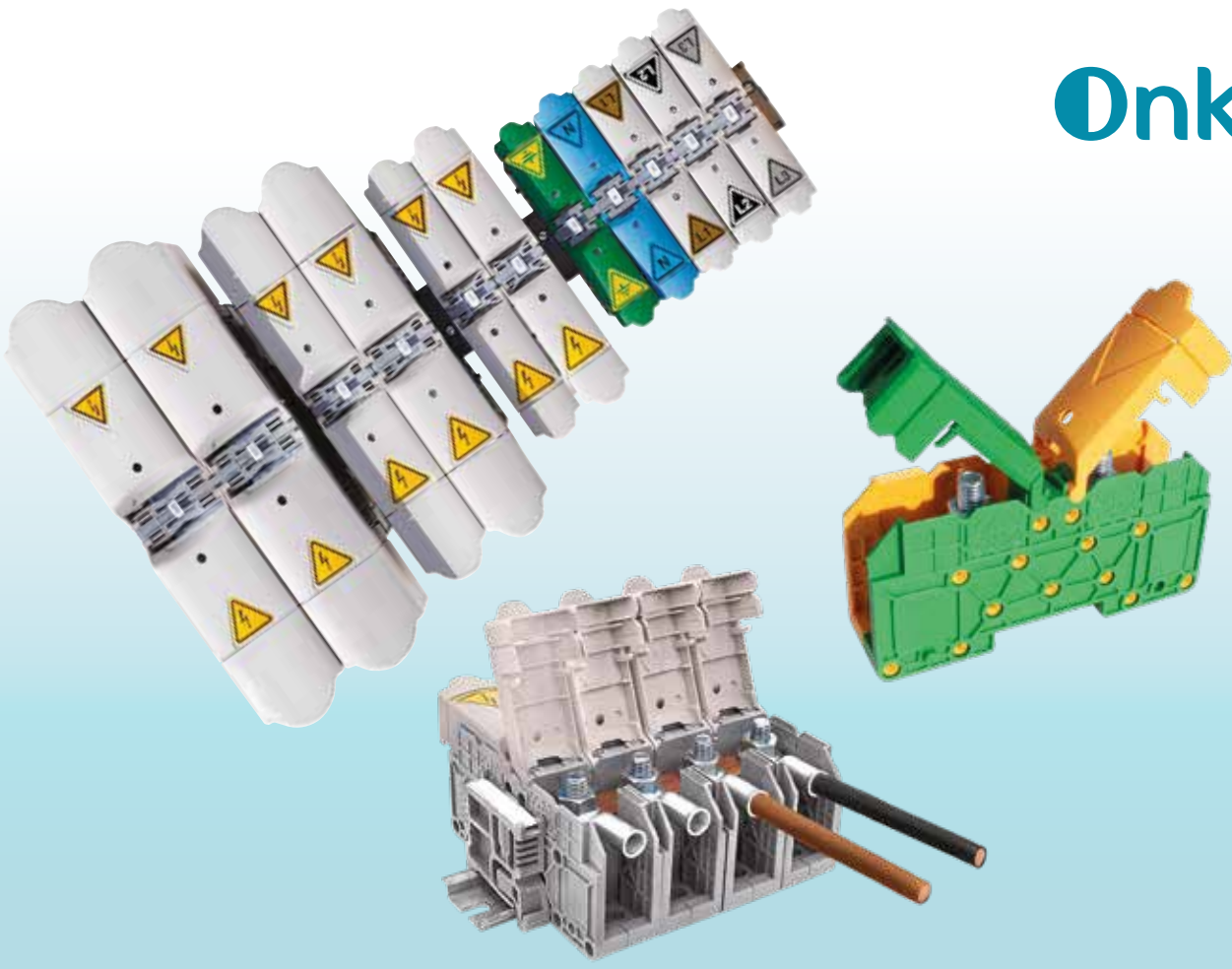







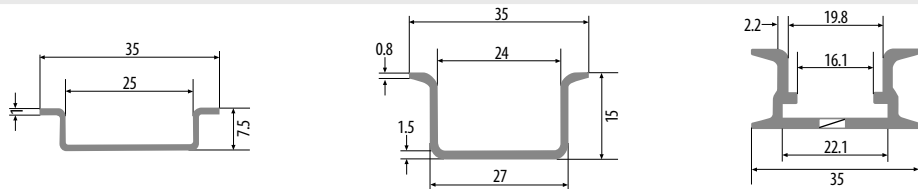





































MRK SERİSİ PABUÇ BAĞLANTILI BARALI RAY KLEMENSLER (KAPAKLI)

CİNSİ	GERİLİM / AKIM (V/A)	KUTU ADEDİ	RENK	YENİ KOD	ESKİ KOD	ADET (t)
25 mm ² Pabuç Bağlantılı, Baralı, Kapaklı	1000 V / 100 A	10/140		1030001	ONKA-2301	154,63
				1030002	ONKA-2302	
				1030003	ONKA-2303	
				1030004	ONKA-2304	
				1030005	ONKA-2305	
				1030006	ONKA-2306	
				1030007	ONKA-2307	
				1030008	ONKA-2308	
				1030009	ONKA-2309	
			35 mm ² Pabuç Bağlantılı, Baralı, Kapaklı	1000 V / 125 A	10/140	
	1030017	ONKA-2322				
	1030018	ONKA-2323				
	1030019	ONKA-2324				
	1030020	ONKA-2325				
	1030021	ONKA-2326				
	1030022	ONKA-2327				
	1030023	ONKA-2328				
	1030024	ONKA-2329				

MONTAJ RAYI ÇEŞİTLERİ



MRK SERİSİ PABUÇ BAĞLANTILI BARALI RAY KLEMENSLER (KAPAKLI)

CİNSİ	GERİLİM / AKIM (V/A)	KUTU ADEDİ	RENK	YENİ KOD	ESKİ KOD	ADET (t)
50 mm ² Pabuç Bağlantılı, Baralı, Kapaklı	1000 V / 150 A	10/140		1030030	ONKA-2341	183,24
				1030031	ONKA-2342	
				1030032	ONKA-2343	
				1030033	ONKA-2344	
				1030034	ONKA-2345	
				1030035	ONKA-2346	
				1030036	ONKA-2347	
				1030037	ONKA-2348	
				1030038	ONKA-2349	
70 mm ² Pabuç Bağlantılı, Baralı, Kapaklı	1000 V / 192 A	10/80		1030044	ONKA-2361	239,23
				1030045	ONKA-2362	
				1030046	ONKA-2363	
				1030047	ONKA-2364	
				1030048	ONKA-2365	
				1030049	ONKA-2366	
				1030050	ONKA-2367	
				1030051	ONKA-2368	
				1030052	ONKA-2369	
95 mm ² Pabuç Bağlantılı, Baralı, Kapaklı	1000 V / 232 A	10/80		1030058	ONKA-2381	279,62
				1030059	ONKA-2382	
				1030060	ONKA-2383	
				1030061	ONKA-2384	
				1030062	ONKA-2385	
				1030063	ONKA-2386	
				1030064	ONKA-2387	
				1030065	ONKA-2388	
				1030066	ONKA-2389	
120 mm ² Pabuç Bağlantılı, Baralı, Kapaklı	1000 V / 269 A	5/30		1030072	ONKA-2401	479,12
				1030073	ONKA-2402	
				1030074	ONKA-2403	
				1030075	ONKA-2404	
				1030076	ONKA-2405	
				1030077	ONKA-2406	
				1030078	ONKA-2407	
				1030079	ONKA-2408	
				1030080	ONKA-2409	
150 mm ² Pabuç Bağlantılı, Baralı, Kapaklı	1000 V / 309 A	5/30		1030087	ONKA-2421	536,81
				1030088	ONKA-2422	
				1030089	ONKA-2423	
				1030090	ONKA-2424	
				1030091	ONKA-2425	
				1030092	ONKA-2426	
				1030093	ONKA-2427	
				1030094	ONKA-2428	
				1030095	ONKA-2429	

MRK SERİSİ PABUÇ BAĞLANTILI BARALI RAY KLEMENSLER (KAPAKLI)

CİNSİ	GERİLİM / AKIM (V/A)	KUTU ADEDİ	RENK	YENİ KOD	ESKİ KOD	ADET (t)
185 mm ² Pabuç Bağlantılı, Baralı, Kapaklı	1000 V / 353 A	5/20		1030101	ONKA-2441	621,74
				1030102	ONKA-2442	
				1030103	ONKA-2443	
				1030104	ONKA-2444	
				1030105	ONKA-2445	
				1030106	ONKA-2446	
				1030107	ONKA-2447	
				1030108	ONKA-2448	
				1030109	ONKA-2449	
240 mm ² Pabuç Bağlantılı, Baralı, Kapaklı	1000 V / 415 A	5/20		1030115	ONKA-2461	745,92
				1030116	ONKA-2462	
				1030117	ONKA-2463	
				1030118	ONKA-2464	
				1030119	ONKA-2465	
				1030120	ONKA-2466	
				1030121	ONKA-2467	
				1030122	ONKA-2468	
				1030123	ONKA-2469	

MARKALAMA SİSTEMLERİ

DAĞITICI ÜNİTELER

W OTOMAT BARALARI VE MONTAJ RAYLARI

SIKMALI KABLO PABUÇLARI

SIRA KLEMENSLER

MRK SERİSİ PABUÇ BAĞLANTILI BARALI RAY KLEMENSLER İÇİN ÜÇGEN ETİKET



ÜRÜN KODU	CİNSİ	ADET (t)	PLAKA ADEDİ
ONKA-2473	25 mm Üçgen Etiket (DİKKAT)	4,95 €	1 PLAKA (132 ADET)
ONKA-2474	25 mm Üçgen Etiket (NÖTR)	4,95 €	1 PLAKA (132 ADET)
ONKA-2477	25 mm Üçgen Etiket (TOPRAK)	4,95 €	1 PLAKA (132 ADET)
ONKA-2478	25 mm Üçgen Etiket (FAZ)	4,95 €	1 PLAKA 44 TAKIM (132 ADET)

KABLO VE PANO AKSESUARLARI

KABLO RAKORLARI

KABLO KANALLARI VE RAY TİPİ PRİZLER

KABLO UÇLARI

KABLO BAĞLARI VE AKSESUARLARI

DİĞER ÜRÜNLER



MRK SERİSİ ÇİFT KATLI (DOUBLE) RAY KLEMENSLER

CİNSİ	GERİLİM / AKIM (V/A)	KUTU ADEDİ	RENK	YENİ KOD	ESKİ KOD	ADET (₺)	YENİ KOD (V0)	ESKİ KOD (V0)	ADET (V0) (₺)
MRK-Ç 2,5 mm ²	750 V / 24 A	50		1010331	ONKA-1611	31,85	1010411	ONKA-0732	34,50
				1010332	ONKA-1612				
				1010333	ONKA-1613				
				1010334	ONKA-1614				
				1010335	ONKA-1615				
				1010336	ONKA-1616				
				1010337	ONKA-1617				
				1010338	ONKA-1618				
				1010339	ONKA-1619				
MRK-Ç 2,5 mm ²	750 V / 24 A	50		1010340	ONKA-1621	63,91	1010407	ONKA-0482	66,75
				1010341	ONKA-1622				
				1010342	ONKA-1623				
				1010343	ONKA-1624				
				1010344	ONKA-1625				
				1010345	ONKA-1626				
				1010346	ONKA-1627				
				1010347	ONKA-1628				
				1010348	ONKA-1629				

İçten Köprülü

MONTAJ RAYI ÇEŞİTLERİ

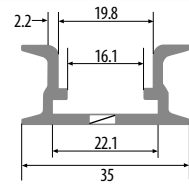
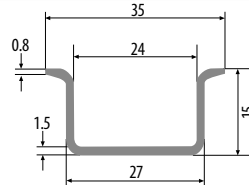
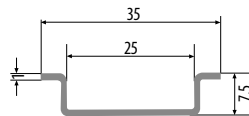

MRK SERİSİ ÇİFT KATLI (DOUBLE) RAY KLEMENSLER

CİNSİ	GERİLİM / AKIM (V/A)	KUTU ADEDİ	RENK	YENİ KOD	ESKİ KOD	ADET (t)	YENİ KOD (V0)	ESKİ KOD (V0)	ADET (V0) (t)		
MRK-Ç 4 mm ²	750 V / 32 A	50		1010367	ONKA-1651	39,13			41,59		
				1010368	ONKA-1652					1010410	ONKA-0722
				1010369	ONKA-1653						
				1010370	ONKA-1654						
				1010371	ONKA-1655						
				1010372	ONKA-1656						
				1010373	ONKA-1657						
				1010374	ONKA-1658						
				1010375	ONKA-1659						
MRK-Ç 4 mm ²	750 V / 32 A	50		1010376	ONKA-1661	68,83			71,30		
				1010377	ONKA-1662					1010408	ONKA-0492
				1010378	ONKA-1663						
				1010379	ONKA-1664						
				1010380	ONKA-1665						
				1010381	ONKA-1666						
				1010382	ONKA-1667						
				1010383	ONKA-1668						
				1010384	ONKA-1669						

MRK SERİSİ ÇİFT KATLI DİYOTLU RAY KLEMENSLER

CİNSİ	GERİLİM / AKIM (V/A)	KUTU ADEDİ	RENK	YENİ KOD	ESKİ KOD	ADET (t)	YENİ KOD (V0)	ESKİ KOD (V0)	ADET (V0) (t)		
MRK-Ç 2,5 mm ²	750 V /	50		1010349	ONKA-1631	63,91			67,00		
				1010350	ONKA-1632					1010406	ONKA-0402
				1010351	ONKA-1633						
				1010352	ONKA-1634						
				1010353	ONKA-1635						
				1010354	ONKA-1636						
				1010355	ONKA-1637						
				1010356	ONKA-1638						
				1010357	ONKA-1639						
MRK-Ç 4 mm ²	750 V /	50		1010385	ONKA-1671	68,91			71,63		
				1010386	ONKA-1672					1010405	ONKA-0392
				1010387	ONKA-1673						
				1010388	ONKA-1674						
				1010389	ONKA-1675						
				1010390	ONKA-1676						
				1010391	ONKA-1677						
				1010392	ONKA-1678						
				1010393	ONKA-1679						

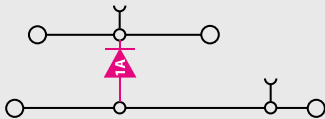

Diyot Yönünü Belirtiniz!

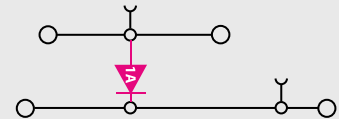

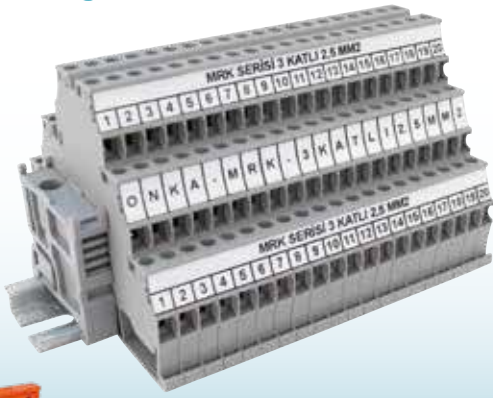

Yalnız kendi üst köprüleri ile kullanılır.



Farklı fonksiyon türevleri için satış temsilcilerimizle iletişime geçiniz.

MRK SERİSİ ÜÇ KATLI VİDA BAĞLANTILI RAY KLEMENS

CİNSİ	GERİLİM / AKIM (V/A)	KUTU ADEDİ	RENK	ÜRÜN KODU	ADET (t)	ÜRÜN KODU (V0)	ADET (V0) (t)
MRK-3K 2,5 mm ²	750 V / 24 A	50		1010424	50,95	1010478	55,05
				1010425		1010479	
				1010426		1010480	
				1010427		1010481	
				1010428		1010482	
				1010429		1010483	
				1010430		1010484	
				1010431		1010485	
				1010432		1010486	
			MRK-3K 2,5 mm ² Köprülü	750 V / 24 A		50	
	1010434	1010488					
	1010435	1010489					
	1010436	1010490					
	1010437	1010491					
	1010438	1010492					
	1010439	1010493					
	1010440	1010494					
	1010441	1010495					
MRK-3K 2,5 mm ² Topraklamalı	750 V / 24 A	50					1010414

MRK SERİSİ ÜÇ KATLI RAY KLEMENS ÜST KÖPÜLERİ



CİNSİ	RENK	ÜRÜN KODU	ADET (t)	KUTU ADEDİ
MRK Üç Katlı 2,5 mm ² - 2'li Üst Köprü		1060206	10,88	100
MRK Üç Katlı 2,5 mm ² - 3'ü Üst Köprü		1060207	13,59	100
MRK Üç Katlı 2,5 mm ² - 4'lü Üst Köprü		1060208	16,18	75
MRK Üç Katlı 2,5 mm ² - 10'lu Üst Köprü		1060209	32,84	30
MRK Üç Katlı 2,5 mm ² - 20'li Üst Köprü		1060210	58,21	20

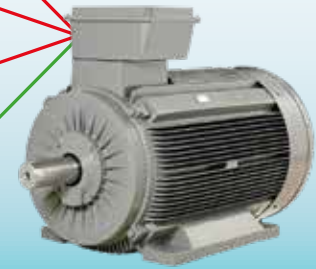
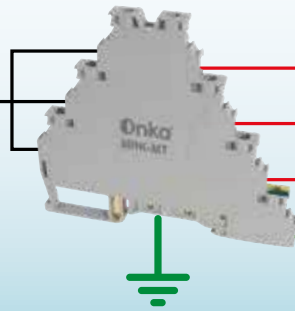
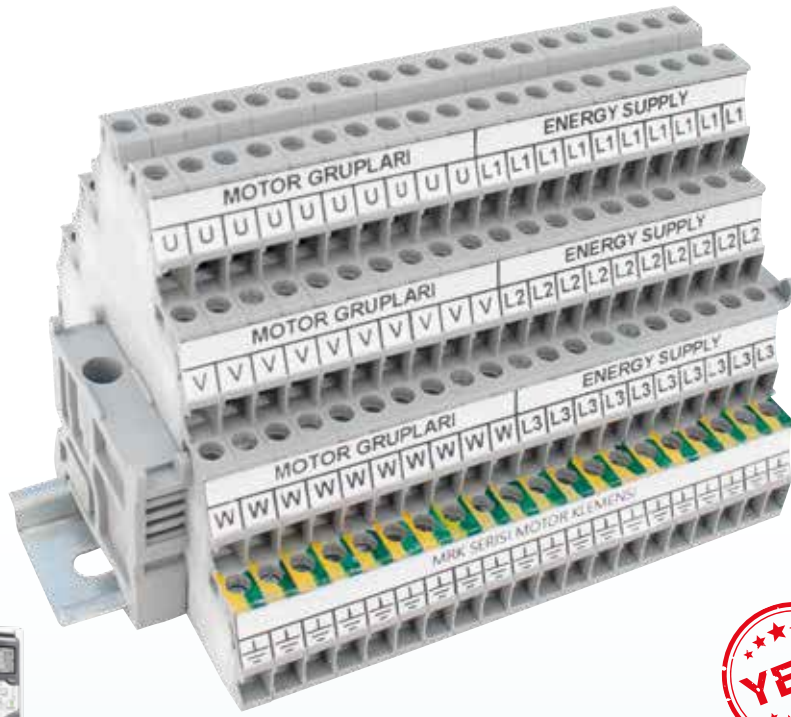

MRK SERİSİ VİDA BAĞLANTILI MOTOR KLEMENS

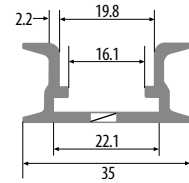
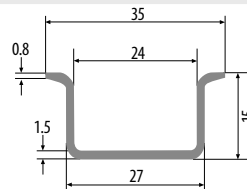
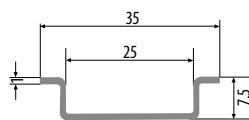

CİNSİ	GERİLİM / AKIM (V/A)	KUTU ADEDİ	RENK	ÜRÜN KODU	ADET (t)	ÜRÜN KODU (V0)	ADET (V0) (t)
MRK-MT 2,5 mm ²	750 V / 24 A	50	➔	1010412	81,98	1010413	86,41

MONTAJ RAYI ÇEŞİTLERİ

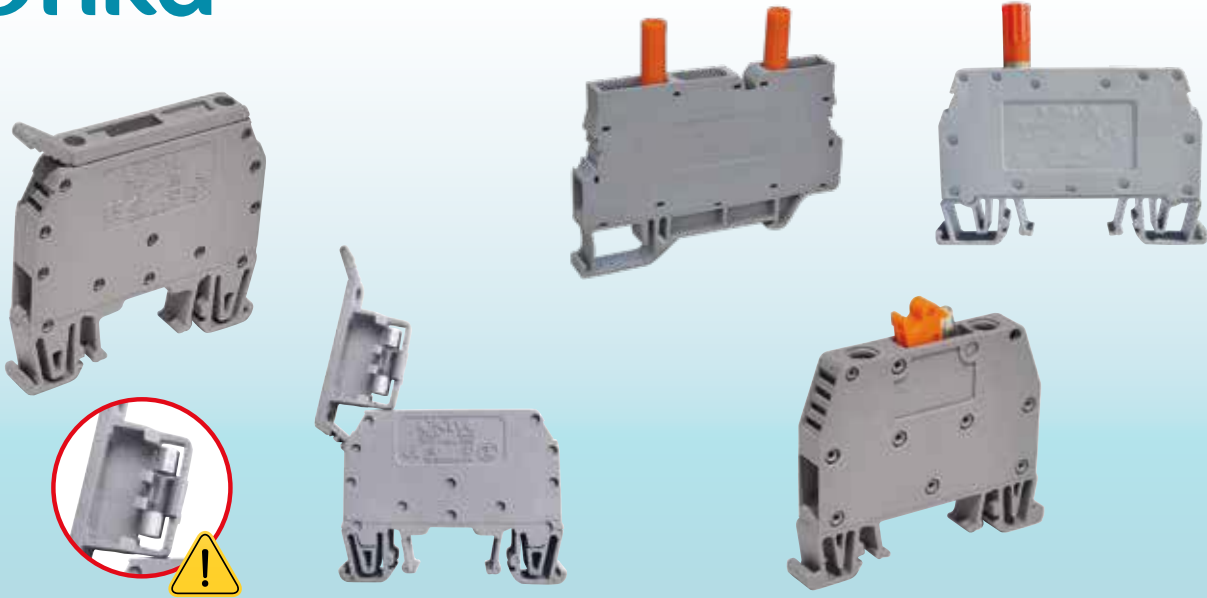

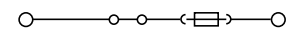

MRK-S SERİSİ SİGORTALI RAY KLEMENSLER BARALI ve LEDLİ

cinsi	GERİLİM / AKIM (V/A)	KUTU ADEDİ	RENK	YENİ KOD	ESKİ KOD	ADET (t)	
MRK-S 6 mm ²	750 V / 6,3 A	100	→	1010240	ONKA-1321	66,34	
			→	1010241	ONKA-1322		
   *5x20 mm Cam Sigorta ile kullanılır.	750 V / 6,3 A	100	→	1010242	ONKA-1323		
			→	1010243	ONKA-1324		
			→	1010244	ONKA-1325		
			→	1010245	ONKA-1326		
			→	1010246	ONKA-1327		
			→	1010247	ONKA-1328		
			→	1010248	ONKA-1329		
			→	1010249	ONKA-1331		
			→	1010250	ONKA-1332		
			→	1010251	ONKA-1333		
MRK-S 6 mm ² Baralı	750 V / 6,3 A	100	→	1010252	ONKA-1334		72,75
			→	1010253	ONKA-1335		
			→	1010254	ONKA-1336		
			→	1010255	ONKA-1337		
			→	1010256	ONKA-1338		
			→	1010257	ONKA-1339		
			→	1010258	ONKA-1340		

CAM SİGORTA







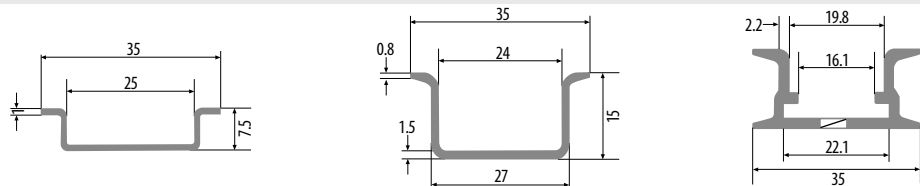











































cinsi	ÜRÜN KODU	ADET (t)	KUTU ADEDİ
5x20 mm Cam Sigorta (0,2.....10A Sigorta Akımını Belirtiniz.)	WE-FS-52	⊕	100

MONTAJ RAYI ÇEŞİTLERİ





MRK-S SERİSİ SİĞORTALI RAY KLEMENSLER BARALI ve LEDLİ

cinsi	GERİLİM / AKIM (V/A)	KUTU ADEDİ	RENK	YENİ KOD	ESKİ KOD	ADET (t)
 <p>*5x20 mm Cam Sigorta ile kullanılır.</p>	12 V / 24 A	100		1010258	ONKA-1341	123,20
				1010259	ONKA-1342	
				1010260	ONKA-1343	
				1010261	ONKA-1344	
				1010262	ONKA-1345	
				1010263	ONKA-1346	
				1010264	ONKA-1347	
				1010265	ONKA-1348	
				1010266	ONKA-1349	
			 <p>*5x20 mm Cam Sigorta ile kullanılır.</p>	24 V / 24 A	100	
	1010268	ONKA-1352				
	1010269	ONKA-1353				
	1010270	ONKA-1354				
	1010271	ONKA-1355				
	1010272	ONKA-1356				
	1010273	ONKA-1357				
	1010274	ONKA-1358				
	1010275	ONKA-1359				
 <p>*5x20 mm Cam Sigorta ile kullanılır.</p>	48 V / 24 A	100				
				1010286	ONKA-1372	
				1010287	ONKA-1373	
				1010288	ONKA-1374	
				1010289	ONKA-1375	
				1010290	ONKA-1376	
				1010291	ONKA-1377	
				1010292	ONKA-1378	
				1010293	ONKA-1379	
			 <p>*5x20 mm Cam Sigorta ile kullanılır.</p>	110 V / 24 A	100	
	1010304	ONKA-1392				
	1010305	ONKA-1393				
	1010306	ONKA-1394				
	1010307	ONKA-1395				
	1010308	ONKA-1396				
	1010309	ONKA-1397				
	1010310	ONKA-1398				
	1010311	ONKA-1399				
 <p>*5x20 mm Cam Sigorta ile kullanılır.</p>	220 V / 24 A	100				
				1010313	ONKA-1402	
				1010314	ONKA-1403	
				1010315	ONKA-1404	
				1010316	ONKA-1405	
				1010317	ONKA-1406	
				1010318	ONKA-1407	
				1010319	ONKA-1408	
				1010320	ONKA-1409	





MRK ÖLÇME & AYIRMA KLEMENSİ 6 mm²

cinsi	GERİLİM / AKIM (V/A)	KUTU ADEDİ	RENK	YENİ KOD	ESKİ KOD	ADET (t)
Probsuz	750 V / 41 A	50	→	1010218	ONKA-1286	63,53
			→	1010217	ONKA-1285	
			→	1010211	ONKA-1278	
Tek Test Probu	750 V / 41 A	50	→	1010214	ONKA-1282	82,64
			→	1010213	ONKA-1281	
Çift Test Probu	750 V / 41 A	50	→	1010216	ONKA-1284	102,71
			→	1010215	ONKA-1283	
			→	1010212	ONKA-1279	

MRK ÖLÇME & AYIRMA KLEMENSİ 6 mm² AKSESUARLARI

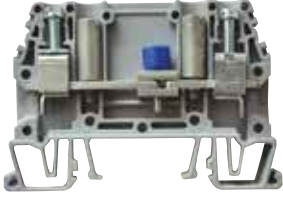
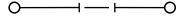
	cinsi	YENİ KOD	ESKİ KOD	ADET (t)	KUTU ADEDİ
	MRK 6 mm ² - 2'li Standart Üst Köprü	1060116	ONKA-1935	18,07	100
	MRK 6 mm ² - 3'lü Standart Üst Köprü	1060117	ONKA-1936	24,08	50
	MRK 6 mm ² - 4'lü Standart Üst Köprü	1060118	ONKA-1937	30,51	50
	MRK 6 mm ² - 10'lü Standart Üst Köprü	1060119	ONKA-1938	68,49	15
	MRK 6 mm ² - 20'li Standart Üst Köprü	1060120	ONKA-1939	127,63	10
	MRK 6 mm ² - 2'li Çatal Tip Üst Köprü	1060147	ONKA-1970	13,99	10
	MRK 6 mm ² - 3'lü Çatal Tip Üst Köprü	1060148	ONKA-1971	18,49	10
	MRK 6 mm ² - 4'lü Çatal Tip Üst Köprü	1060149	ONKA-1972	24,03	10
	MRK 6 mm ² - 6'li Çatal Tip Üst Köprü	1060150	ONKA-1973	33,37	10
	MRK 6 mm ² - 10'lü Çatal Tip Üst Köprü	1060151	ONKA-1974	53,14	10
	MRK 6 mm ² Ölçme Ayırma Test Probu	1060073	ONKA-1280	12,50	10

MRK ÖLÇME & AYIRMA KLEMENSİ 10 mm²

cinsi	GERİLİM / AKIM (V/A)	KUTU ADEDİ	RENK	YENİ KOD	ESKİ KOD	ADET (t)
Çift Kovanlı	750 V / 57 A	75	➔	1010236	ONKA-1312	88,93
						
Tek Test Probu	750 V / 57 A	50	➔	1010230	ONKA-1306	101,39
						
Çift Test Probu	750 V / 57 A	50	➔	1010232	ONKA-1308	143,23
						

MARKALAMA SİSTEMLERİ

DAĞITICI ÜNİTELER

W OTOMAT BARALARI VE MONTAJ RAYLARI





SIKMALI KABLO PABUÇLARI

SIRA KLEMENSİLER

KABLO VE PANO AKSESUARLARI

KABLO RAKORLARI

MRK ÖLÇME & AYIRMA KLEMENSİ 10 mm² AKSESUARLARI

	cinsi	YENİ KOD	ESKİ KOD	ADET (t)	KUTU ADEDİ
	MRK 10 mm ² - 2'li Üst Köprü	1060078	ONKA-1303	14,24	50
	MRK 10 mm ² - 4'lü Üst Köprü	1060080	ONKA-1318	21,76	50
	MRK 10 mm ² - 8'lü Üst Köprü	1060077	ONKA-1302	35,45	50
	MRK 10 mm ² Ölçme Ayırma Test Probu	1060081	ONKA-1319	39,11	50
	MRK 10 mm ² Ölçme Ayırma Test Kovanı	1060079	ONKA-1304	16,80	50

KABLO KAVALLARI VE RAY TİPİ PRİZLER

KABLO UÇLARI

KABLO BAĞLARI VE AKSESUARLARI

DİĞER ÜRÜNLER

MRK TEST KLEMENSİ 6 mm² (Bıçaklı Kapalı Sistem)

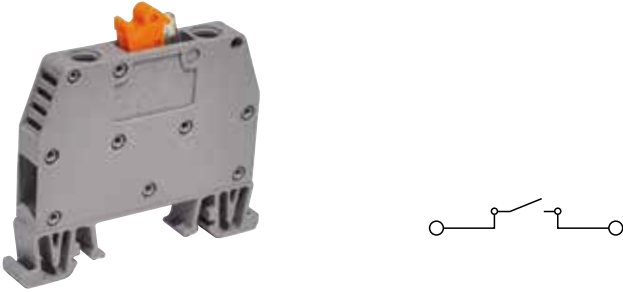
Cinsi	GERİLİM / AKIM (V/A)	KUTU ADEDİ	RENK	YENİ KOD	ESKİ KOD	ADET (t)
Bıçaklı Sistem	750 V / 41 A	100				
			→	1010239	ONKA-1317	40,33
			→	1010238	ONKA-1316	

MRK SERİSİ EK ALMA KLEMENSİ (Maksimum 16 mm²)

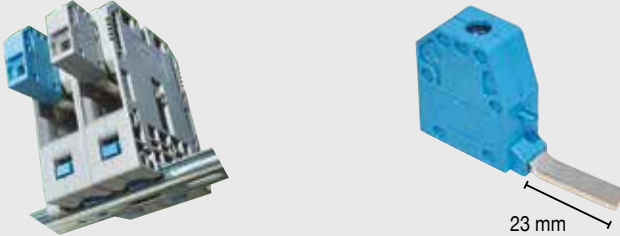
Cinsi	GERİLİM / AKIM (V/A)	KUTU ADEDİ	RENK	YENİ KOD	ESKİ KOD	ADET (t)
35 - 50 mm ²	750 V / 76 A	100	→	1060055	ONKA-1161	33,86
			→	1060056	ONKA-1162	
			→	1060057	ONKA-1163	
			→	1060058	ONKA-1164	
			→	1060059	ONKA-1165	
			→	1060060	ONKA-1166	
			→	1060061	ONKA-1167	
			→	1060062	ONKA-1168	
			→	1060063	ONKA-1169	
	70 - 95 - 120 mm ²	750 V / 76 A	100	→	1060064	ONKA-1171
			→	1060065	ONKA-1172	
			→	1060066	ONKA-1173	
			→	1060067	ONKA-1174	
			→	1060068	ONKA-1175	
			→	1060069	ONKA-1176	
			→	1060070	ONKA-1177	
			→	1060071	ONKA-1178	
			→	1060072	ONKA-1179	

MONTAJ RAYI ÇEŞİTLERİ

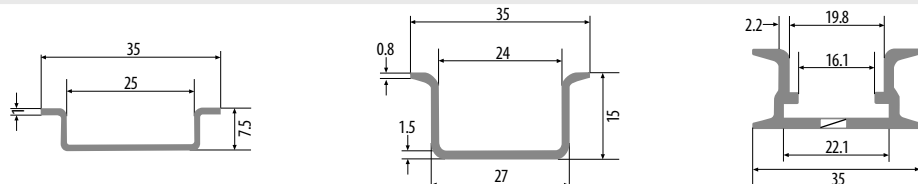

HİBRİT BAĞLANTILI RAY KLEMENS



YENİ HRK SERİSİ

- 2,5-6 mm² Kesit
- 10 Farklı Renk Seçeneği
- 0,34-6 mm² Aralığında Yüksüklü / Yüksüksüz, Tek Damarlı / Çok Telli (Flexible) Bağlantılar
- Renk Kodlama / Dekafix / Şerit Etiketleme olanaklarıyla evrensel markalama avantajları sağlar.
- Üst köprü imkanıyla beyan akımı dahilinde bara oluşturmak, çoklu bağlantı devreleriyle toplama ve dağıtım çözümleri elde etmek mümkündür.

AKSESUARLAR

- 35 mm DIN Rayı
- 2,5 ve 6 mm² Üst Köprüler
- MRK ve OPK Serisi Dekafixler
- MRK ve OPK Serisi Durdurucular

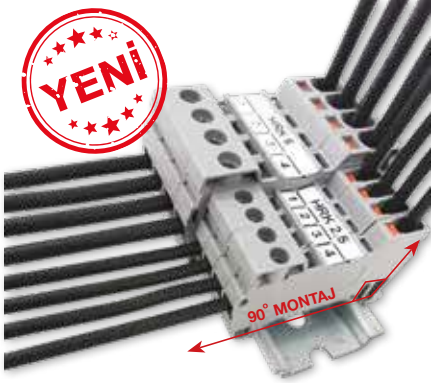

Vida ve Push-in bağlantı teknolojilerinin her ikisine de sahip bu ürün ile montör ve son kullanıcı koordinasyonunu güçlendiriyoruz.



Kullanıcılar arasında, montörler için hız, operatörler için emniyetin ön planda olduğu projelerde;

Vidalı mı / Yay bağlantılı mı? sorusunu ortadan kaldıran Hibrit ürünümüzle 60947-7-1 direktiflerinin tüm kriterlerinde üstün performans sağlarken farklı yönlerden birleşen kablolar için 90° bağlantı imkanıyla panolarınıza ergonomi ve estetik katıyoruz.









































HİBRİT BAĞLANTILI RAY KLEMENS

Cinsi	GERİLİM / AKIM (V/A)	KUTU ADEDİ	RENK	YENİ KOD	ESKİ KOD	ADET (t)	YENİ KOD (V0)	ESKİ KOD (V0)	ADET (V0) (t)
HRK 2,5 mm ²	750 V / 24 A	100		1040001		12,32	1040021		12,88
				1040002	ONKA-0362		1040022	ONKA-0332	
				1040003			1040023		
				1040004			1040024		
				1040005			1040025		
				1040006			1040026		
				1040007			1040027		
				1040008			1040028		
				1040009			1040029		
HRK 6 mm ²	750 V / 41 A	100		1040011		22,28	1040031		23,25
				1040012	ONKA-0372		1040032	ONKA-0342	
				1040013			1040033		
				1040014			1040034		
				1040015			1040035		
				1040016			1040036		
				1040017			1040037		
				1040018			1040038		
				1040019			1040039		







MRK SERİSİ TOPRAKLAMA KLEMENSLERİ

CİNSİ	GERİLİM (V)	RENK	YENİ KOD	ESKİ KOD	ADET (t)	KUTU ADEDİ
	750 V		1010219	ONKA-1291	39,27	100
	750 V		1010220	ONKA-1293	41,13	100
	750 V		1010541	-	46,74	100
	750 V		1010221	ONKA-1294	61,86	100
	750 V		1010532	-	152,75	50
  YÜKSÜKSÜZ	750 V		1010223	ONKA-1297	174,56	50
	750 V		1010533	-	170,39	30
	750 V		1010225	ONKA-1296	192,78	30

MRK VE OPK SERİSİ DURDURUCULAR

CİNSİ	KUTU ADEDİ	RENK	YENİ KOD	ESKİ KOD	ADET (t)
Küçük Durdurucu 	100		1060013	ONKA-1221	7,95
			1060014	ONKA-1222	
			1060015	ONKA-1223	
			1060016	ONKA-1224	
			1060017	ONKA-1225	
			1060018	ONKA-1226	
			1060019	ONKA-1227	
			1060020	ONKA-1228	
			1060021	ONKA-1229	
		Büyük Durdurucu  <p>*ONKA-8920-736SE/SB Sticker ile işaretlenebilir.</p>	100		
	1060005			ONKA-1212	
	1060006			ONKA-1213	
	1060007			ONKA-1214	
	1060008			ONKA-1215	
	1060009			ONKA-1216	
	1060010			ONKA-1217	
	1060011			ONKA-1218	
	1060012			ONKA-1219	
Grup Etiketli Durdurucu  <p>*ONKA-8920-736SE/SB Sticker ile işaretlenebilir.</p>	100				1060023
			1060024	ONKA-1232	
			1060025	ONKA-1233	
			1060026	ONKA-1234	
			1060027	ONKA-1235	
			1060028	ONKA-1236	
			1060029	ONKA-1237	
			1060030	ONKA-1238	
			1060031	ONKA-1239	
		Ray Klemens Grup Etiketli  <p>*ONKA-8920-736SE/SB Sticker ile işaretlenebilir.</p>	100		
	1060500				
	1060501				
	1060502				
	1060503				
	1060504				
	1060505				
	1060506				
	1060507				



MRK VE OPK SERİSİ VİDASIZ DURDURUCU VE ÜSTTEN GEÇMELİ GRUP ETİKETİ

CİNSİ	KUTU ADEDİ	RENK	YENİ KOD	ESKİ KOD	ADET (t)
Vidasız Durdurucu   <p>*ONKA-8920-736SE/SB Sticker ile işaretlenebilir.</p>	100		1060001	ONKA-1201	11,09
			1060002	ONKA-1202	
			1060003	ONKA-1203	
Üstten Geçmeli Grup Etiketi 	100		1060093	ONKA-1482	2,46

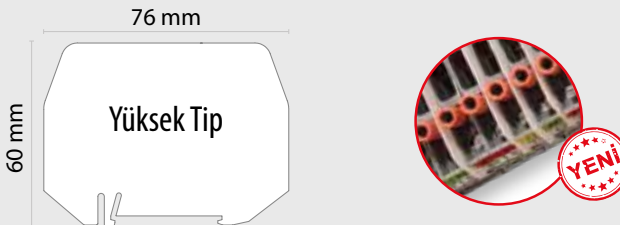
MRK SERİSİ AYIRMA PLAKASI

CİNSİ	KUTU ADEDİ	RENK	YENİ KOD	ESKİ KOD	ADET
Ayrırma Plakası	25	→	1060051	ONKA-0582	6,33 ₺
		→	1060052	ONKA-0587	
MRK-OPK Yüksek Tip Ayrırma Plakası	25	⇒	ONKA-0999		0,21 €
					

MRK RAY KLEMENS İŞARETLERİ VE ETİKET YUVASI

CİNSİ	YENİ KOD	ESKİ KOD	ADET (₺)	KUTU ADEDİ
	1060074	ONKA-1287	0,85 ₺	1000
	1060076	ONKA-1289	0,41 ₺	1000
	ONKA-8943-S11		29 €	1

MRK SERİSİ RAY KLEMENS ÜST KÖPRÜ (Vidalı)



ÜRÜN AÇIKLAMASI	YENİ KOD	ESKİ KOD	ADET (₺)	KUTU ADEDİ
MRK 16mm ² / 2 Vidalı Üst Köprü	1060152	ONKA-2257	49,77	10
MRK 16mm ² / 3 Vidalı Üst Köprü	1060153	ONKA-2258	74,59	10
MRK 16mm ² / 4 Vidalı Üst Köprü	1060154	ONKA-2259	99,16	10
MRK 16mm ² / 5 Vidalı Üst Köprü	1060155	ONKA-2260	124,16	10
MRK 16mm ² / 10 Vidalı Üst Köprü	1060160	ONKA-2265	248,45	10
MRK 35mm ² / 10 Vidalı Üst Köprü	1060169	ONKA-2274	272,93	10

MRK SERİSİ RAY KLEMENS ÜST KÖPRÜ (Geçmeli)

Köprü üzerindeki kesme kanalları sayesinde pin aralığının merkezinden kesim imkanı sağlar.

* Bu özellik 10 Pinli ve 20 Pinli üst köprüler için geçerlidir.

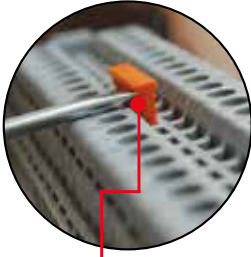
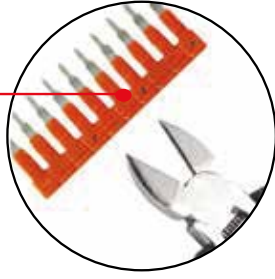

Köprü üzerindeki form sayesinde tornavida ile demonte edilebilir.

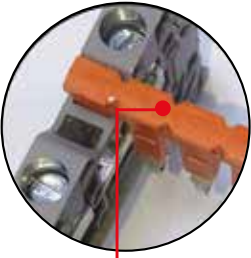

İzole gövdenin tek parça olması iletken baraya yüksek dayanıklılık sağlar.

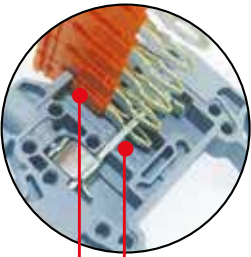

Tutucu form ile güvenli bağlantı sağlanır.

Formlu Pin yapısıyla baraya dört noktadan sürekli ve güvenli temas sağlanır.



SADECE MRK SERİSİ İLE KULLANILIR.



GİNSİ	RENK	ÜRÜN KODU	ESKİ KOD	ADET (t)	KUTU ADEDİ
1,5 x 2	→	1060101	ONKA-1920	12,10	100
1,5 x 3	→	1060102	ONKA-1921	15,27	100
1,5 x 4	→	1060103	ONKA-1922	18,84	100
1,5 x 10	→	1060104	ONKA-1923	39,11	30
1,5 x 20	→	1060105	ONKA-1924	70,15	20
2,5 x 2	→	1060106	ONKA-1925	12,78	100
2,5 x 3	→	1060107	ONKA-1926	17,16	100
2,5 x 4	→	1060108	ONKA-1927	19,57	75
2,5 x 10	→	1060109	ONKA-1928	42,92	30
2,5 x 20	→	1060110	ONKA-1929	79,92	20
4 x 2	→	1060111	ONKA-1930	13,92	100
4 x 3	→	1060112	ONKA-1931	19,51	50
4 x 4	→	1060113	ONKA-1932	21,79	50
4 x 10	→	1060114	ONKA-1933	48,35	30
4 x 20	→	1060115	ONKA-1934	86,80	20
6 x 2	→	1060116	ONKA-1935	18,07	100
6 x 3	→	1060117	ONKA-1936	24,08	50
6 x 4	→	1060118	ONKA-1937	30,51	50
6 x 10	→	1060119	ONKA-1938	68,49	15
6 x 20	→	1060120	ONKA-1939	127,63	10
10 x 2	→	1060121	ONKA-1940	19,97	100
10 x 3	→	1060122	ONKA-1941	26,91	50
10 x 4	→	1060123	ONKA-1942	33,02	50
10 x 10	→	1060124	ONKA-1943	73,49	15
10 x 20	→	1060125	ONKA-1944	149,98	10

Onka®

11 mm
Şerit Etiket
Takılabilir.

PUSH IN



OPK SERİSİ

Yay Bağlantılı Ray Klemensler

- Push-in Sistem.
- Nihayet plakası gerektirmez. (Her iki tarafı kapalı)
- Daha iyi bir izolasyon ve maliyet avantajı sağlar.
- 1 Katlılar simetrikler. (Her iki yönde raya monte edilebilir)
- Daha düşük kablo itme kuvvetiyle kolay montaj.
- Zaman ve maliyet tasarrufu.
- Yalıtkan butonlar sayesinde montaj esnasında iletken kısma sıfır temas.
- Paslanmaz çelik itici yaylar.
- 0,25 mm² 'den 35 mm² 'ye kadar yüksüklü kablolarda el aleti gerektirmeden montaj imkanı.
- Renk Kodlama / Dekafix / Şerit Etiketleme olanaklarıyla evrensel markalama avantajları

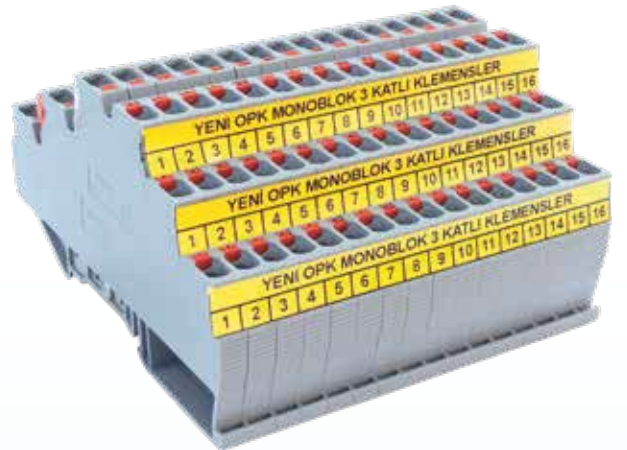



2,5 - 4 - 6 - 10 mm² yay baskılı push-in klemenslerde şerit markalama sistemi uygulanabilir.



Çift giriş - çift çıkış, tek giriş - çift çıkış, çift giriş - çift çıkış bıçaklı ayırma test klemenslerinde şerit markalama sistemi uygulanabilir.

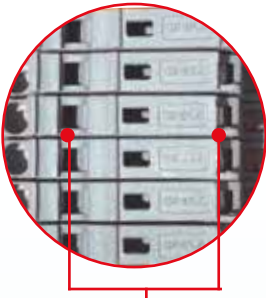
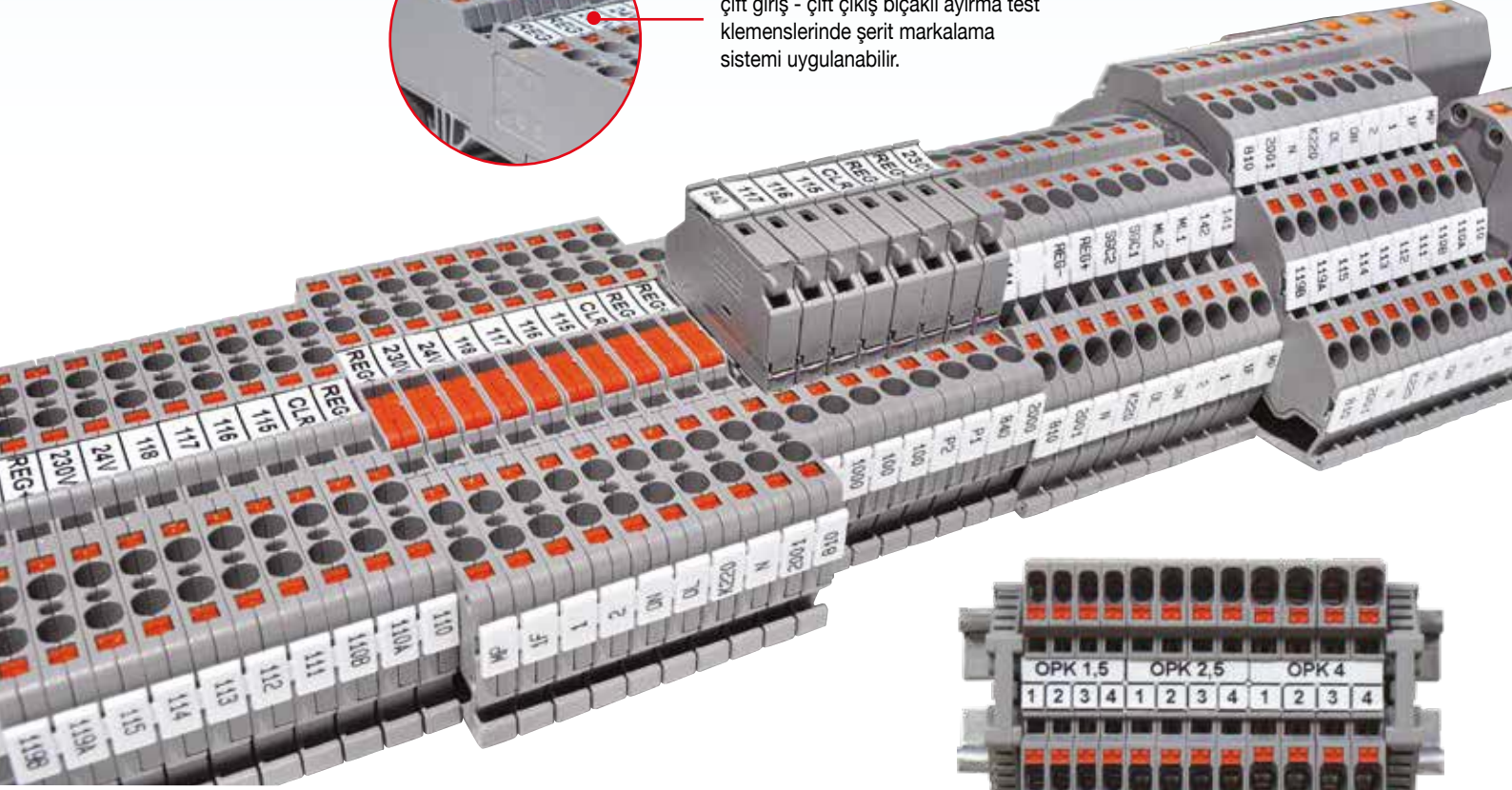

OPK sigortalı klemensde sigortanın her iki kutbu önünde bulunan ölçüm noktaları sayesinde devreyi açmadan ve sigortayı çıkartmadan muayene ve kontrol yapılabilir.



Çift yönlü köprüleme

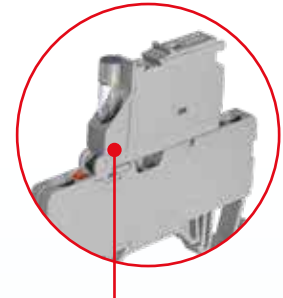

OPK Serisi sigortalı klemenslerde yedek cam sigorta yuvası bulunmaktadır.

MONTAJ RAYI ÇEŞİTLERİ

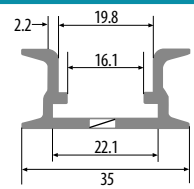
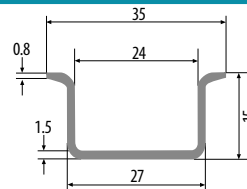
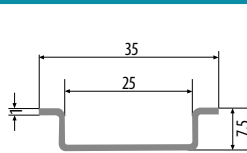

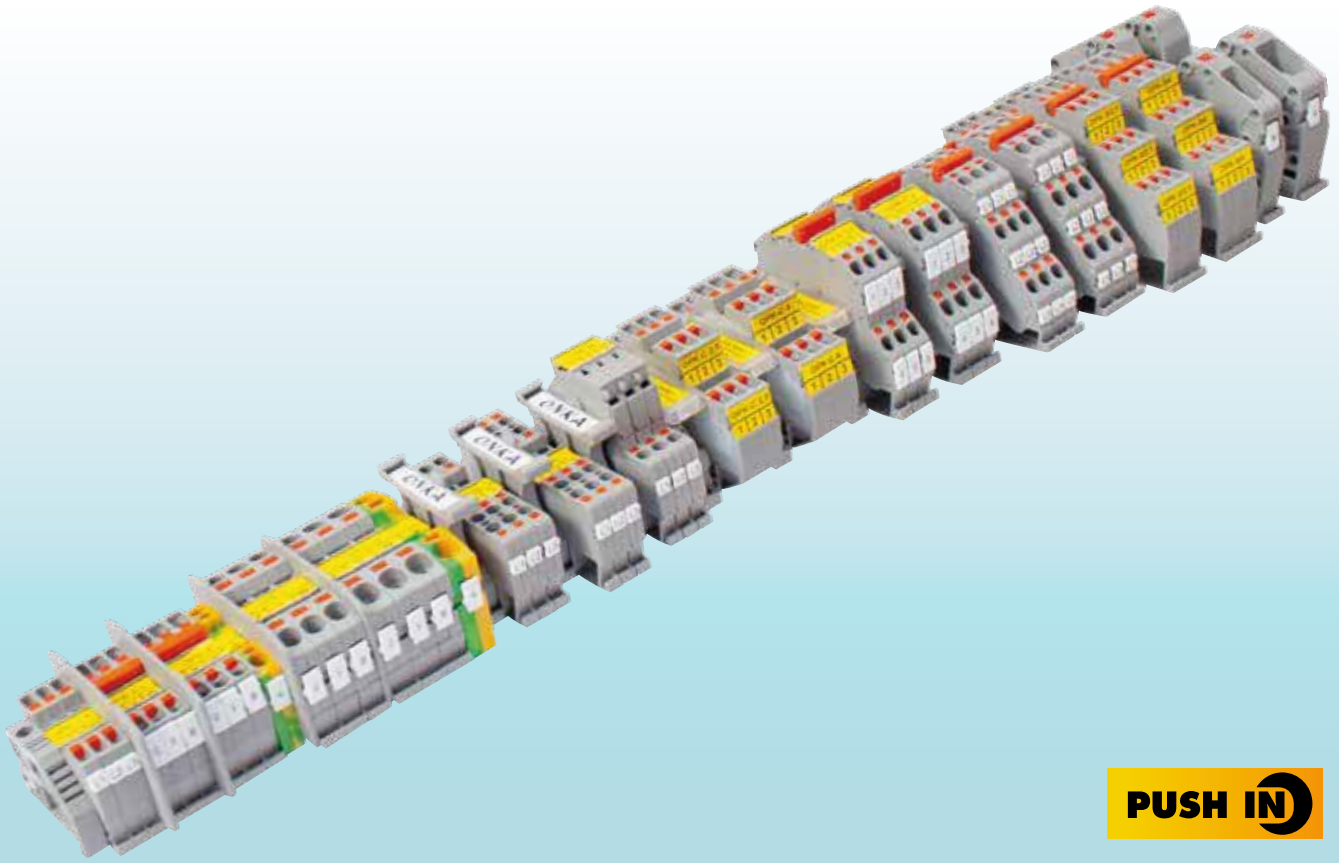

PUSH IN







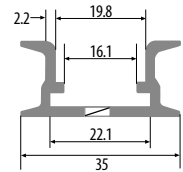
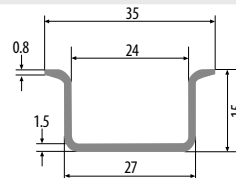
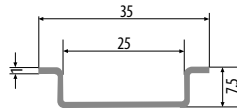











































OPK SERİSİ YAY BAĞLANTILI RAY KLEMENSLER (PUSH-IN SİSTEM HER İKİ TARAFI KAPALI)

CİNSİ	GERİLİM / AKIM (V/A)	KUTU ADEDİ	RENK	YENİ KOD	ESKİ KOD	ADET (t)	YENİ KOD (V0)	ESKİ KOD (V0)	ADET (V0) (t)
OPK 1,5 mm ²	750 V / 17,5 A	100		1020001	ONKA-1591	11,61	1020073	ONKA-0531	12,38
				1020002	ONKA-1592		1020074	ONKA-0532	
				1020003	ONKA-1593		1020075	ONKA-0533	
				1020004	ONKA-1594		1020076	ONKA-0534	
				1020005	ONKA-1595		1020077	ONKA-0535	
				1020006	ONKA-1596		1020078	ONKA-0536	
				1020007	ONKA-1597		1020079	ONKA-0537	
				1020008	ONKA-1598		1020080	ONKA-0538	
				1020009	ONKA-1599		1020081	ONKA-0539	
			OPK 2,5 mm ²	750 V / 24 A	100			1020012	
	1020013	ONKA-1502				1020083	ONKA-0922		
	1020014	ONKA-1503							
	1020015	ONKA-1504				1020084	ONKA-0924		
	1020016	ONKA-1505				1020085	ONKA-0925		
	1020017	ONKA-1506				1020086	ONKA-0926		
	1020018	ONKA-1507				1020087	ONKA-0927		
	1020019	ONKA-1508							
	1020020	ONKA-1509				1020088	ONKA-0929		

MONTAJ RAYI ÇEŞİTLERİ



OPK SERİSİ YAY BAĞLANTILI RAY KLEMENSLER (PUSH-IN SİSTEM HER İKİ TARFI KAPALI)

CİNSİ	GERİLİM / AKIM (V/A)	KUTU ADEDİ	RENK	YENİ KOD	ESKİ KOD	ADET (t)	YENİ KOD (V0)	ESKİ KOD (V0)	ADET (V0) (t)
OPK 4 mm ²	750 V / 32 A	100		1020023	ONKA-1511	17,70	1020089	ONKA-0931	18,90
				1020024	ONKA-1512		1020090	ONKA-0932	
				1020025	ONKA-1513				
				1020026	ONKA-1514		1020091	ONKA-0934	
				1020027	ONKA-1515		1020092	ONKA-0935	
				1020028	ONKA-1516		1020093	ONKA-0936	
				1020029	ONKA-1517		1020094	ONKA-0937	
				1020030	ONKA-1518				
				1020031	ONKA-1519		1020095	ONKA-0939	
				1020032	ONKA-1520				
OPK 6 mm ²	750 V / 41 A	100		1020033	ONKA-1521	26,62			28,02
				1020034	ONKA-1522		1020096	ONKA-0942	
				1020035	ONKA-1523				
				1020036	ONKA-1524				
				1020037	ONKA-1525				
				1020038	ONKA-1526				
				1020039	ONKA-1527				
				1020040	ONKA-1528				
				1020041	ONKA-1529				
				1020042	ONKA-1530				
OPK 10 mm ²	750 V / 57 A	100		1020043	ONKA-1531	41,35			43,84
				1020044	ONKA-1532		1020097	ONKA-0952	
				1020045	ONKA-1533				
				1020046	ONKA-1534				
				1020047	ONKA-1535				
				1020048	ONKA-1536				
				1020049	ONKA-1537				
				1020050	ONKA-1538				
				1020051	ONKA-1539				
				1020052	ONKA-1540				
OPK 16 mm ²	750 V / 76 A	30		1020053	ONKA-1541	112,83			119,08
				1020054	ONKA-1542		1020098	ONKA-0962	
				1020055	ONKA-1543				
				1020056	ONKA-1544				
				1020057	ONKA-1545				
				1020058	ONKA-1546				
				1020059	ONKA-1547				
				1020060	ONKA-1548				
				1020061	ONKA-1549				
				1020062	ONKA-1550				
OPK 35 mm ²	750 V / 125 A	20		1020063	ONKA-1551	144,18			153,01
				1020064	ONKA-1552		1020099	ONKA-0972	
				1020065	ONKA-1553				
				1020066	ONKA-1554				
				1020067	ONKA-1555				
				1020068	ONKA-1556				
				1020069	ONKA-1557				
				1020070	ONKA-1558				
				1020071	ONKA-1559				
				1020072	ONKA-1560				

SOKETLİ RAY KLEMENS

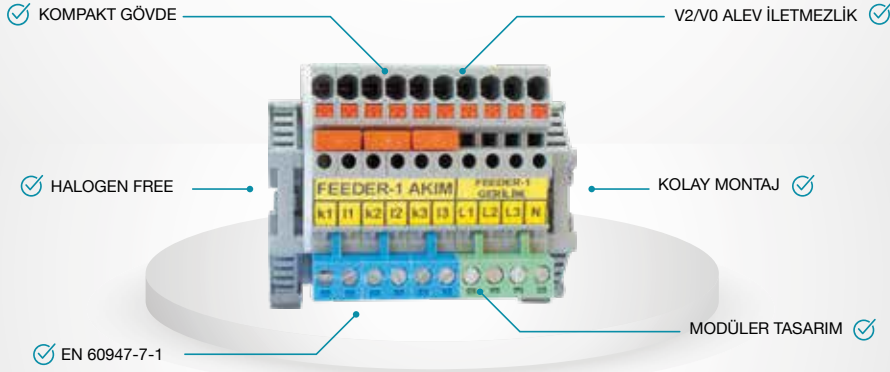

Onka®

Profesyonellerin Tercihii

PC-P Serisi soketli ray klemenslerimiz ile;

- Çok Pinli Plug-in Bağlantı Çözümleri
- Modüler Pano, Makina, Asansör vb. Uygulamalarınız için Hızlı Montaj / Demontaj
- Markalama Seçenekleri ile Doğru ve Kolay Bağlantı
- Modüler Yapısı ve Artırılabilir Kutup Sayısı ile Esnek Çözümler

YAY BAĞLANTILI SOKETLİ RAY KLEMENS

2,5 mm² / 5,08 mm

CİNSİ	GERİLİM / AKIM (V/A)	KUTU ADEDİ	RENK	YENİ KOD	ESKİ KOD	ADET (t)	YENİ KOD (V0)	ESKİ KOD (V0)	ADET (V0) (t)
PC-P 2,5 mm ²	750 V / 16 A	50	→		ONKA-0381	14,26		ONKA-0321	14,69
			→	1020302	ONKA-0382		1020304	ONKA-0322	
			→		ONKA-0383			ONKA-0323	
			→		ONKA-0384			ONKA-0324	
			→		ONKA-0385			ONKA-0325	
			→		ONKA-0386			ONKA-0326	
			→		ONKA-0387			ONKA-0327	
			→		ONKA-0388			ONKA-0328	
			→		ONKA-0389			ONKA-0329	
			PCP-N Nihayet Plakası		10		⇨	1020301	

PC-P SOKET SEÇENEKLERİ



PİN	ÜRETİM KODU	SİPARİŞ KODU (Renk ve Pin Sayısı Seçiniz!)						KUTU ADEDİ	ADET (\$)
		10	11	12	13	14	15		
2	SBDK 5,08-D/2	10.202	11.202	12.202	13.202	14.202	15.202	200	☎
3	SBDK 5,08-D/3	10.203	11.203	12.203	13.203	14.203	15.203	100	
4	SKBDK 5,08-D/4	10.204	11.204	12.204	13.204	14.204	15.204	100	
5	SBDK 5,08-D/5	10.205	11.205	12.205	13.205	14.205	15.205	100	
6	SBDK 5,08-D/6	10.206	11.206	12.206	13.206	14.206	15.206	100	
7	SBDK 5,08-D/7	10.207	11.207	12.207	13.207	14.207	15.207	100	
8	SBDK 5,08-D/8	10.208	11.208	12.208	13.208	14.208	15.208	100	
9	SBDK 5,08-D/9	10.209	11.209	12.209	13.209	14.209	15.209	100	
10	SBDK5,08-D/10	10.210	11.210	12.210	13.210	14.210	15.210	50	
11	SBDK 5,08-D/11	10.211	11.211	12.211	13.211	14.211	15.211	50	
12	SBDK 5,08-D/12	10.212	11.212	12.212	13.212	14.212	15.212	50	

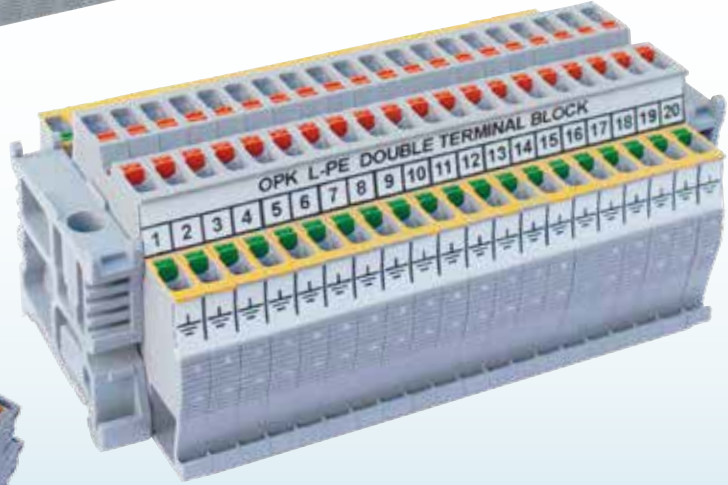
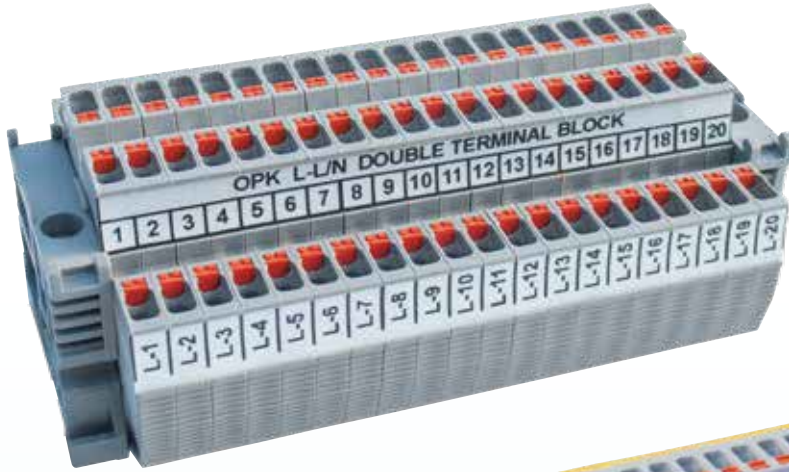

OPK SERİSİ YAY BAĞLANTILI MONOBLOK İKİ KATLI (DOUBLE) KLEMENSLER

2,5 mm²

CİNSİ	GERİLİM / AKIM (V/A)	KUTU ADEDİ	RENK	ÜRÜN KODU	ADET (t)	ÜRÜN KODU (V0)	ADET (V0) (t)
OPK-C 2,5 mm ² (Monoblok)	750 V / 24 A	50		1020440	34,00	1020467	36,10
				1020441		1020468	
				1020442		1020469	
				1020443		1020470	
				1020444		1020471	
				1020445		1020472	
				1020446		1020473	
				1020447		1020474	
				1020448		1020475	

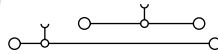



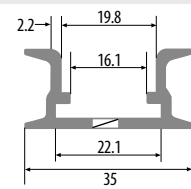
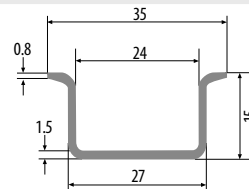
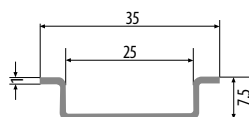



MONTAJ RAYI ÇEŞİTLERİ

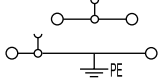

OPK SERİSİ YAY BAĞLANTILI MONOBLOK İKİ KATLI (DOUBLE) KLEMENSLER

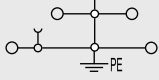
CİNSİ	GERİLİM / AKIM (V/A)	KUTU ADEDİ	RENK	YENİ KOD	ADET (t)	YENİ KOD (V0)	ADET (V0) (t)
OPK-C 2,5 mm ² (Monoblok) İçten Köprülü	750 V / 24 A	50		1020449	64,41	1020476	66,79
				1020450		1020477	
				1020451		1020478	
				1020452		1020479	
				1020453		1020480	
				1020454		1020481	
				1020455		1020482	
				1020456		1020483	
				1020457		1020484	
				1020458		1020485	
OPK-C 2,5 mm ² (Monoblok) Diyotlu Yönlü	750 V /	50		1020458	68,36	1020485	70,74
				1020459		1020486	
				1020460		1020487	
				1020461		1020488	
				1020462		1020489	
				1020463		1020490	
				1020464		1020491	
				1020465		1020492	
				1020466		1020493	
			OPK-C 4 mm ² (Monoblok)	750 V / 32 A		50	
	1020495	1020522					
	1020496	1020523					
	1020497	1020524					
	1020498	1020525					
	1020499	1020526					
	1020500	1020527					
	1020501	1020528					
	1020502	1020529					
OPK-C 4 mm ² (Monoblok) İçten Köprülü	750 V / 32 A	50					1020503
				1020504	1020531		
				1020505	1020532		
				1020506	1020533		
				1020507	1020534		
				1020508	1020535		
				1020509	1020536		
				1020510	1020537		
				1020511	1020538		
			OPK-C 4 mm ² (Monoblok) Diyotlu Yönlü	750 V /	50		1020512
	1020513	1020540					
	1020514	1020541					
	1020515	1020542					
	1020516	1020543					
	1020517	1020544					
	1020518	1020545					
	1020519	1020546					
	1020520	1020547					

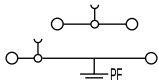
OPK SERİSİ YAY BAĞLANTILI İKİ KATLI TOPRAKLAMALI KLEMENSLER

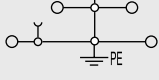
CİNSİ	GERİLİM / AKIM (V/A)	KUTU ADEDİ	RENK	ÜRÜN KODU	ADET (t)	ÜRÜN KODU (V0)	ADET (V0) (t)
OPK-C 2,5 mm ² (Monoblok) L-Pe	750 V / 24 A	50	➔	1020432	51,50	1020434	53,51
							
OPK-C 2,5 mm ² (Monoblok) Pe-Pe (İçten Köprülü)	750 V / 24 A	50	➔	1020433	77,43		
							
OPK-C 4 mm ² (Monoblok) L-Pe	750 V / 32 A	50	➔	1020436	53,71		
							
OPK-C 4 mm ² (Monoblok) Pe-Pe (İçten Köprülü)	750 V / 32 A	50	➔	1020437	79,64		
							

MARKALAMA SİSTEMLERİ

DAĞITICI ÜNİTELER

W OTOMAT BARALARI VE MONTAJ RAYLARI

SIKMALI KABLO PABUÇLARI

SIRA KLEMENSLER

KABLO VE PANO AKSESUARLARI

KABLO RAKORLARI

KABLO KANALLARI VE RAY TİPİ PRİZLER

KABLO UÇLARI

KABLO BAĞLARI VE AKSESUARLARI

DİĞER ÜRÜNLER

OPK SERİSİ YAY BAĞLANTILI İKİ KATLI (DOUBLE) KLEMENSLER

CİNSİ	GERİLİM / AKIM (V/A)	KUTU ADEDİ	RENK	YENİ KOD	ESKİ KOD	ADET (t)	YENİ KOD (V0)	ESKİ KOD (V0)	ADET (V0) (t)		
OPK-C 2,5 mm ²	750 V / 24 A	50		1020100	ONKA-1781	37,79			40,62		
				1020101	ONKA-1782					1020210	ONKA-0702
				1020102	ONKA-1783						
				1020103	ONKA-1784					1020562	
				1020104	ONKA-1785						
				1020105	ONKA-1786					1020561	
				1020106	ONKA-1787					1020211	ONKA-0707
				1020107	ONKA-1788						
				1020108	ONKA-1789						
OPK-C 2,5 mm ² İçten Köprülü	750 V / 24 A	50		1020109	ONKA-2571	56,52			59,72		
				1020110	ONKA-2572					1020215	ONKA-0472
				1020111	ONKA-2573						
				1020112	ONKA-2574						
				1020113	ONKA-2575						
				1020114	ONKA-2576						
				1020115	ONKA-2577						
				1020116	ONKA-2578						
				1020117	ONKA-2579						
OPK-C 2,5 mm ² Diyotlu Yönlü	750 V /	50		1020118	ONKA-2581	72,35		1020214	ONKA-0462		
				1020119	ONKA-2582						
				1020120	ONKA-2583						
				1020121	ONKA-2584						
				1020122	ONKA-2585						
				1020123	ONKA-2586						
				1020124	ONKA-2587						
				1020125	ONKA-2588						
				1020126	ONKA-2589						
OPK-C 4 mm ²	750 V / 32 A	50		1020127	ONKA-1791	44,47			47,55		
				1020128	ONKA-1792					1020209	ONKA-0692
				1020129	ONKA-1793						ONKA-0693
				1020130	ONKA-1794						ONKA-0694
				1020131	ONKA-1795						ONKA-0695
				1020132	ONKA-1796						ONKA-0696
				1020133	ONKA-1797						ONKA-0697
				1020134	ONKA-1798						ONKA-0698
				1020135	ONKA-1799						ONKA-0699
OPK-C 4 mm ² İçten Köprülü	750 V / 32 A	50		1020136	ONKA-2591	58,20		1020213	ONKA-0451		
				1020137	ONKA-2592						ONKA-0452
				1020138	ONKA-2593						ONKA-0453
				1020139	ONKA-2594						ONKA-0454
				1020140	ONKA-2595						ONKA-0455
				1020141	ONKA-2596						ONKA-0456
				1020142	ONKA-2597						ONKA-0457
				1020143	ONKA-2598						ONKA-0458
				1020144	ONKA-2599						ONKA-0459
OPK-C 4 mm ² Diyotlu Yönlü	750 V /	50		1020145	ONKA-2601	74,04		1020212	ONKA-0441		
				1020146	ONKA-2602						ONKA-0442
				1020147	ONKA-2603						ONKA-0443
				1020148	ONKA-2604						ONKA-0444
				1020149	ONKA-2605						ONKA-0445
				1020150	ONKA-2606						ONKA-0446
				1020151	ONKA-2607						ONKA-0447
				1020152	ONKA-2608						ONKA-0448
				1020153	ONKA-2609						ONKA-0449

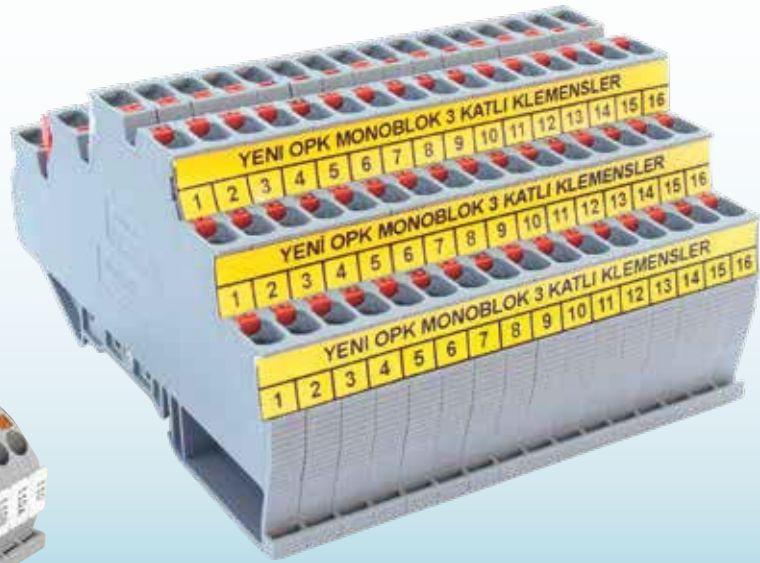

Farklı fonksiyon türevleri için satış temsilcilerimizle iletişime geçiniz.

OPK SERİSİ YAY BAĞLANTILI MONOBLOK ÜÇ KATLI (TRIPLE) KLEMENSLER

CİNSİ	GERİLİM / AKIM (V/A)	KUTU ADEDİ	RENK	YENİ KOD	ADET (t)	YENİ KOD (V0)	ADET (V0) (t)
	750 V / 24 A	50		1020564	60,17	1020682	63,15
				1020565		1020683	
				1020566		1020684	
				1020567		1020685	
				1020568		1020686	
				1020569		1020687	
				1020570		1020688	
				1020571		1020689	
				1020572		1020690	



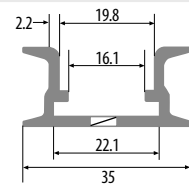
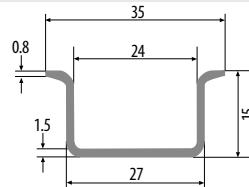
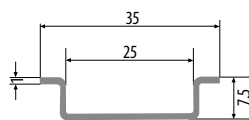







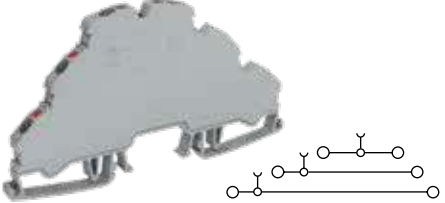



















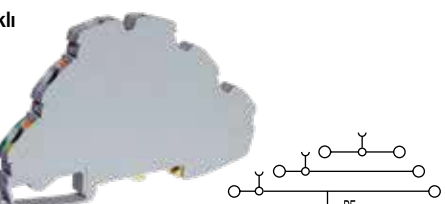













MONTAJ RAYI ÇEŞİTLERİ



OPK SERİSİ YAY BAĞLANTILI MONOBLOK ÜÇ KATLI (TRIPLE) KLEMENSLER



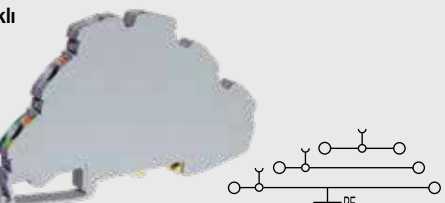



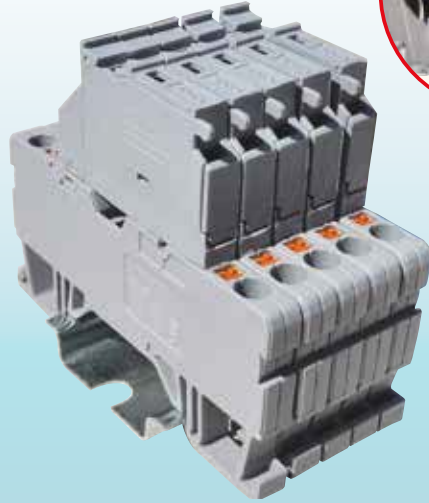



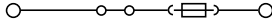







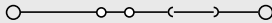

CİNSİ	GERİLİM / AKIM (V/A)	KUTU ADEDİ	RENK	YENİ KOD	ADET (t)	YENİ KOD (V0)	ADET (V0) (t)
OPK-3K 2,5 mm ² İçten Köprülü	750 V / 24 A	50	→	1020582	88,79	1020691	93,20
			→	1020583		1020692	
			→	1020584		1020693	
			→	1020585		1020694	
			→	1020586		1020695	
			→	1020587		1020696	
			→	1020588		1020697	
			→	1020589		1020698	
			→	1020590		1020699	
			OPK-3K 2,5 mm ² Topraklı	750 V / 24 A		50	
→	1020627	1020736					
OPK-3K 4 mm ²	750 V / 32 A	50	→	1020573	70,06	1020741	73,55
			→	1020574		1020742	
			→	1020575		1020743	
			→	1020576		1020744	
			→	1020577		1020745	
			→	1020578		1020746	
			→	1020579		1020747	
			→	1020580		1020748	
			→	1020581		1020749	
			OPK-3K 4 mm ² İçten Köprülü	750 V / 32 A		50	
→	1020633	1020751					
→	1020634	1020752					
→	1020635	1020753					
→	1020636	1020754					
→	1020637	1020755					
→	1020638	1020756					
→	1020639	1020757					
→	1020640	1020758					
OPK-3K 4 mm ² Topraklı	750 V / 32 A	50			→		1020677
			→	1020677	1020795		

OPK SERİSİ YAY BAĞLANTILI ÜÇ KATLI (TRIPLE) KLEMENSLER

CİNSİ	GERİLİM / AKIM (V/A)	KUTU ADEDİ	RENK	YENİ KOD	ESKİ KOD	ADET (t)	YENİ KOD (V0)	ESKİ KOD (V0)	ADET (V0) (t)
OPK-3K 2,5 mm ² 	750 V / 24 A	50		1020154	ONKA-1851	57,54			60,72
				1020155	ONKA-1852				
				1020156	ONKA-1853				
				1020157	ONKA-1854				
				1020158	ONKA-1855				
				1020159	ONKA-1856				
				1020160	ONKA-1857				
				1020161	ONKA-1858				
				1020162	ONKA-1859				
OPK-3K 2,5 mm ² İçten Köprülü 	750 V / 24 A	50		1020163	ONKA-1861	85,97	1020218	ONKA-0432	89,44
				1020164	ONKA-1862				
				1020165	ONKA-1863				
				1020166	ONKA-1864				
				1020167	ONKA-1865				
				1020168	ONKA-1866				
				1020169	ONKA-1867				
				1020170	ONKA-1868				
				1020171	ONKA-1869				
OPK-3K 2,5 mm ² Topraklı 	750 V / 24 A	50		1020174	ONKA-1872	98,89	1020219	ONKA-0672	102,60
OPK-3K 4 mm ² 	750 V / 32 A	50		1020182	ONKA-1881	66,98	1020217	ONKA-0683	71,17
				1020183	ONKA-1882				
				1020184	ONKA-1883				
				1020185	ONKA-1884				
				1020186	ONKA-1885				
				1020187	ONKA-1886				
				1020188	ONKA-1887				
				1020189	ONKA-1888				
				1020190	ONKA-1889				
OPK-3K 4 mm ² İçten Köprülü 	750 V / 32 A	50		1020191	ONKA-1891	91,36	1020221	ONKA-0422	95,37
				1020192	ONKA-1892				
				1020193	ONKA-1893				
				1020194	ONKA-1894				
				1020195	ONKA-1895				
				1020196	ONKA-1896				
				1020197	ONKA-1897				
				1020198	ONKA-1898				
				1020199	ONKA-1899				
OPK-3K 4 mm ² Topraklı 	750 V / 32 A	50		1020201	ONKA-1902	104,74	1020220	ONKA-0412	108,87



OPK SERİSİ YAY BAĞLANTILI SİGORTALI RAY KLEMENS

cinsi	GERİLİM / AKIM (V/A)	KUTU ADEDİ	RENK	YENİ KOD	ESKİ KOD	ADET (t)
   *5x20 mm Cam Sigorta ile kullanılır.	750 V / 6,3 A	50		1020222	ONKA-2481	62,50
				1020223	ONKA-2482	
				1020224	ONKA-2483	
				1020225	ONKA-2484	
				1020226	ONKA-2485	
				1020227	ONKA-2486	
				1020228	ONKA-2487	
				1020229	ONKA-2488	
				1020230	ONKA-2489	
			 	750 V / 6,3 A	50	
	1020232	ONKA-2492				
	1020233	ONKA-2493				
						
						
						
	1020234	ONKA-2497				
						
						

CAM SİGORTA







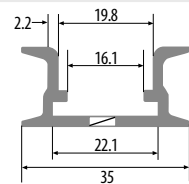
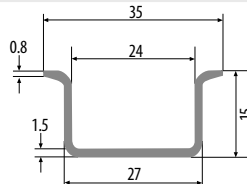
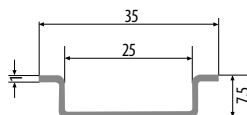



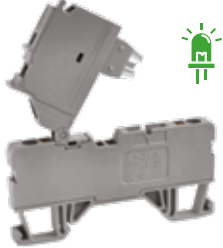









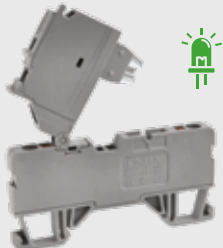







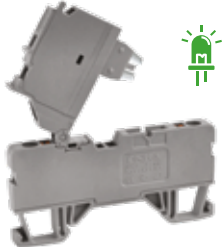









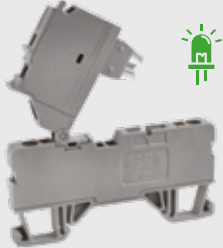









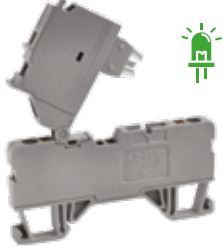

cinsi	ÜRÜN KODU	ADET (t)	KUTU ADEDİ
5x20 mm Cam Sigorta (0,2.....10A Sigorta Akımını Belirtiniz.)	WE-FS-52		100

MONTAJ RAYI ÇEŞİTLERİ



OPK SERİSİ YAY BAĞLANTILI SİGORTALI RAY KLEMENS

cinsi	GERİLİM / AKIM (V/A)	KUTU ADEDİ	RENK	YENİ KOD	ESKİ KOD	ADET (t)
	12 V / 6,3 A	50		1020235	ONKA-2501	106,50
				1020236	ONKA-2502	
				1020237	ONKA-2503	
				1020238	ONKA-2504	
				1020239	ONKA-2505	
				1020240	ONKA-2506	
				1020241	ONKA-2507	
				1020242	ONKA-2508	
				1020243	ONKA-2509	
				24 V / 6,3 A	50	
	1020245	ONKA-2512				
	1020246	ONKA-2513				
	1020247	ONKA-2514				
	1020248	ONKA-2515				
	1020249	ONKA-2516				
	1020250	ONKA-2517				
	1020251	ONKA-2518				
	1020252	ONKA-2519				
	48 V / 6,3 A	50				
				1020254	ONKA-2532	
					ONKA-2533	
					ONKA-2534	
					ONKA-2535	
					ONKA-2536	
					ONKA-2537	
					ONKA-2538	
					ONKA-2539	
				110 V / 6,3 A	50	
	1020256	ONKA-2552				
		ONKA-2553				
		ONKA-2554				
		ONKA-2555				
		ONKA-2556				
		ONKA-2557				
		ONKA-2558				
		ONKA-2559				
	220 V / 6,3 A	50				
				1020258	ONKA-2562	
					ONKA-2563	
					ONKA-2564	
				1020259	ONKA-2565	
				1020260	ONKA-2566	
					ONKA-2567	
					ONKA-2568	
					ONKA-2569	



1 Giriş / 2 Çıkış

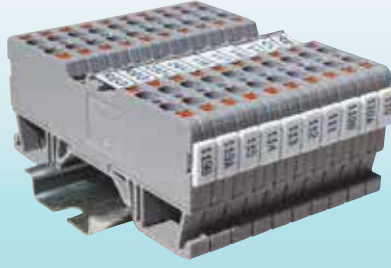

2 Giriş / 2 Çıkış

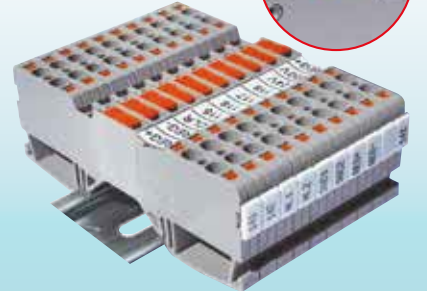

2 Giriş / 2 Çıkış
Test Klemensi

OPK SERİSİ RAY KLEMENS (1 GİRİŞ / 2 ÇIKIŞ)

CİNSİ	GERİLİM / AKIM (V/A)	KUTU ADEDİ	RENK	YENİ KOD	ESKİ KOD	ADET (₺)	YENİ KOD (V0)	ESKİ KOD (V0)	ADET (V0) (₺)
OPK 2,5 / 4 mm ²	750 V / 24 A	50		1020284	ONKA-1261	25,54	1020295	ONKA-0662	26,88
				1020285	ONKA-1262				
				1020286	ONKA-1263				
				1020287	ONKA-1264				
				1020288	ONKA-1265				
				1020289	ONKA-1266				
				1020290	ONKA-1267				
				1020291	ONKA-1268				
				1020292	ONKA-1269				



1 Giriş / 2 Çıkış

OPK SERİSİ RAY KLEMENS (2 GİRİŞ / 2 ÇIKIŞ)

CİNSİ	GERİLİM / AKIM (V/A)	KUTU ADEDİ	RENK	YENİ KOD	ESKİ KOD	ADET (₺)	YENİ KOD (V0)	ESKİ KOD (V0)	ADET (V0) (₺)
OPK 2,5 / 4 mm ²	750 V / 24 A	50		1020274	ONKA-1251	30,98	1020294	ONKA-0652	32,61
				1020275	ONKA-1252				
				1020276	ONKA-1253				
				1020277	ONKA-1254				
				1020278	ONKA-1255				
				1020279	ONKA-1256				
				1020280	ONKA-1257				
				1020281	ONKA-1258				
				1020282	ONKA-1259				



2 Giriş / 2 Çıkış



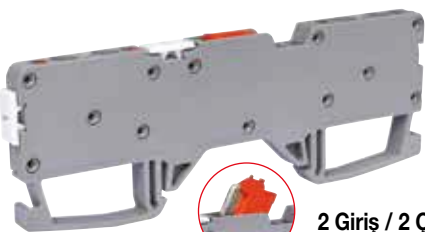

OPK SERİSİ TEST KLEMENSİ (2 GİRİŞ / 2 ÇIKIŞ)

CİNSİ	GERİLİM / AKIM (V/A)	KUTU ADEDİ	RENK	YENİ KOD	ESKİ KOD	ADET (₺)	YENİ KOD (V0)	ESKİ KOD (V0)	ADET (V0) (₺)
OPK 2,5 / 4 mm ²	750 V / 24 A	50		1020264	ONKA-1241	42,09	1020293	ONKA-0642	43,89
				1020265	ONKA-1242				
				1020266	ONKA-1243				
				1020267	ONKA-1244				
				1020268	ONKA-1245				
				1020269	ONKA-1246				
				1020270	ONKA-1247				
				1020271	ONKA-1248				
				1020272	ONKA-1249				

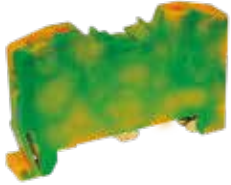

2 Giriş / 2 Çıkış
Test Klemensi

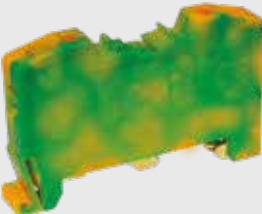

OPK SERİSİ YAY BAĞLANTILI TOPRAKLAMA KLEMENSLERİ

CİNSİ	GERİLİM (V)	RENK	ÜRÜN KODU	ESKİ KOD	ADET (t)	KUTU ADEDİ
	750 V		1020299	ONKA-1199	53,76	100
	750 V		1020300	ONKA-1200	96,85	100









































OPK SERİSİ AYIRMA PLAKASI

CİNSİ	KUTU ADEDİ	RENK	YENİ KOD	ESKİ KOD	ADET
Ayırma Plakası 63,5 mm 	25		1060053	ONKA-0592	6,15 t
			1060054	ONKA-0597	
MRK-OPK Yüksek Tip Ayırma Plakası 76 mm 60 mm 	25		ONKA-0999		0,21 €







OPK RAY KLEMENS İŞARETLERİ VE ETİKET YUVASI

CİNSİ	YENİ KOD	ESKİ KOD	ADET (t)	KUTU ADEDİ
	1060075	ONKA-1288	0,85 t	1000
	1060076	ONKA-1289	0,41 t	1000
	ONKA-8943-S11		29 €	1

MRK VE OPK SERİSİ DURDURUCULAR

CİNSİ	KUTU ADEDİ	RENK	YENİ KOD	ESKİ KOD	ADET (t)			
Küçük Durdurucu 	100		1060013	ONKA-1221	7,95			
			1060014	ONKA-1222				
			1060015	ONKA-1223				
			1060016	ONKA-1224				
			1060017	ONKA-1225				
			1060018	ONKA-1226				
			1060019	ONKA-1227				
			1060020	ONKA-1228				
			1060021	ONKA-1229				
		Büyük Durdurucu  <i>*ONKA-8920-736SE/SB Sticker ile işaretlenebilir.</i>	100			1060004	ONKA-1211	16,17
	1060005			ONKA-1212				
	1060006			ONKA-1213				
	1060007			ONKA-1214				
	1060008			ONKA-1215				
	1060009			ONKA-1216				
	1060010			ONKA-1217				
	1060011			ONKA-1218				
	1060012			ONKA-1219				
Grup Etiketli Durdurucu  <i>*ONKA-8920-736SE/SB Sticker ile işaretlenebilir.</i>	100				1060023	ONKA-1231	16,38	
					1060024	ONKA-1232		
					1060025	ONKA-1233		
			1060026	ONKA-1234				
			1060027	ONKA-1235				
			1060028	ONKA-1236				
			1060029	ONKA-1237				
			1060030	ONKA-1238				
			1060031	ONKA-1239				
		Ray Klemens Grup Etiketli  <i>*ONKA-8920-736SE/SB Sticker ile işaretlenebilir.</i>	100					8,51
	1060500							
	1060501							
	1060502							
	1060503							
	1060504							
	1060505							
	1060506							
	1060507							

MRK VE OPK SERİSİ VİDASIZ DURDURUCU VE ÜSTTEN GEÇMELİ GRUP ETİKETİ

CİNSİ	KUTU ADEDİ	RENK	YENİ KOD	ESKİ KOD	ADET (t)
Vidasız Durdurucu  <i>*ONKA-8920-736SE/SB Sticker ile işaretlenebilir.</i>	100		1060001	ONKA-1201	11,09
			1060002	ONKA-1202	
			1060003	ONKA-1203	
Üstten Geçmeli Grup Etiketi 	100		1060093	ONKA-1482	2,46

OPK SERİSİ RAY KLEMENS ÜST KÖPRÜ (Geçmeli)



Köprü üzerindeki kesme kanalları sayesinde pin aralığının merkezinden kesim imkanı sağlar.

* Bu özellikli 10 Pinli ve 20 Pinli üst köprüler için geçerlidir.



Köprü üzerindeki form sayesinde tornavida ile demonte edilebilir.



İzole gövdenin tek parça olması iletken baraya yüksek dayanıklılık sağlar.

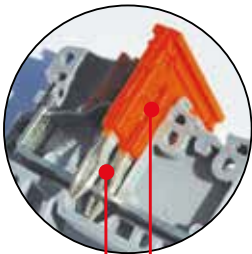

Tutucu form ile güvenli bağlantı sağlar.

Formlu Pin yapısıyla baraya dört noktadan sürekli ve güvenli temas sağlar.

SADECE OPK SERİSİ İLE KULLANILIR.



CİNSİ	RENK	ÜRÜN KODU	ESKİ KOD	ADET (t)	KUTU ADEDİ
1.5 x 2	→	1060101	ONKA-1920	12,10	100
1.5 x 3	→	1060102	ONKA-1921	15,27	100
1.5 x 4	→	1060103	ONKA-1922	18,84	100
1.5 x 10	→	1060104	ONKA-1923	39,11	30
1.5 x 20	→	1060105	ONKA-1924	70,15	20
2.5 x 2	→	1060106	ONKA-1925	12,78	100
2.5 x 3	→	1060107	ONKA-1926	17,16	100
2.5 x 4	→	1060108	ONKA-1927	19,57	75
2.5 x 10	→	1060109	ONKA-1928	42,92	30
2.5 x 20	→	1060110	ONKA-1929	79,92	20
4 x 2	→	1060111	ONKA-1930	13,92	100
4 x 3	→	1060112	ONKA-1931	19,51	50
4 x 4	→	1060113	ONKA-1932	21,79	50
4 x 10	→	1060114	ONKA-1933	48,35	30
4 x 20	→	1060115	ONKA-1934	86,80	20
6 x 2	→	1060126	ONKA-1945	14,93	100
6 x 3	→	1060127	ONKA-1946	18,27	50
6 x 4	→	1060128	ONKA-1947	23,22	50
6 x 10	→	1060129	ONKA-1948	49,03	15
6 x 20	→	1060130	ONKA-1949	93,03	10
10 x 2	→	1060131	ONKA-1950	15,36	100
10 x 3	→	1060132	ONKA-1951	20,19	50
10 x 4	→	1060133	ONKA-1952	25,42	50
10 x 10	→	1060134	ONKA-1953	55,50	15
10 x 20	→	1060135	ONKA-1954	106,89	10
16 x 2	→	1060136	ONKA-1955	19,35	10
16 x 3	→	1060137	ONKA-1956	28,66	10
16 x 4	→	1060138	ONKA-1957	40,23	10
16 x 10	→	1060139	ONKA-1958	86,99	10
35 x 2	→	1060140	ONKA-1959	23,86	10
35 x 3	→	1060141	ONKA-1960	35,10	10
35 x 4	→	1060142	ONKA-1961	48,86	10
35 x 10	→	1060143	ONKA-1962	108,50	10



4,9 mm
Şerit Etiket

5x5mm
Dekafix

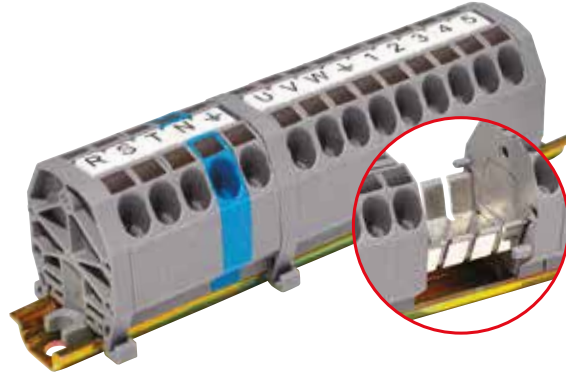
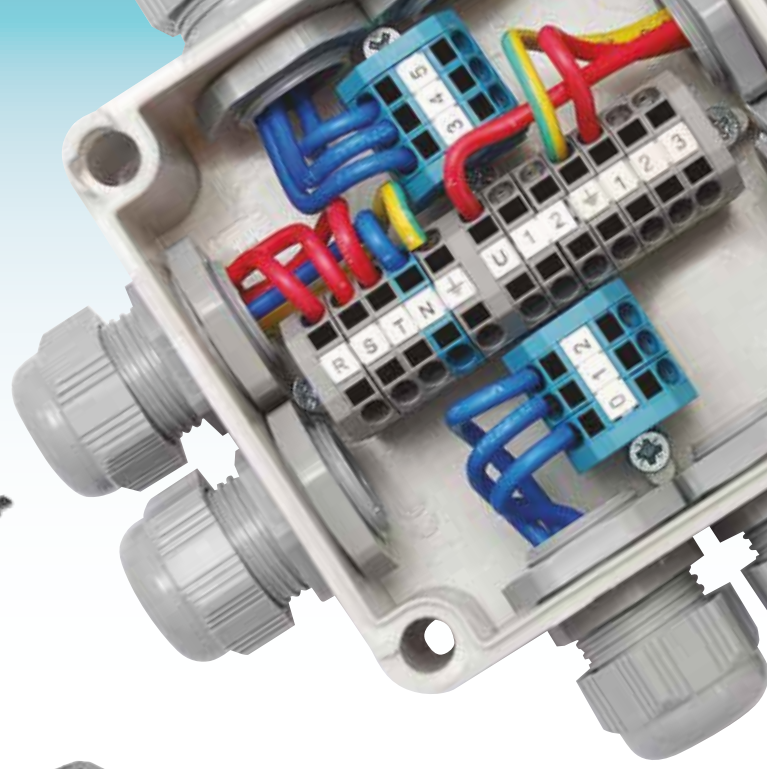
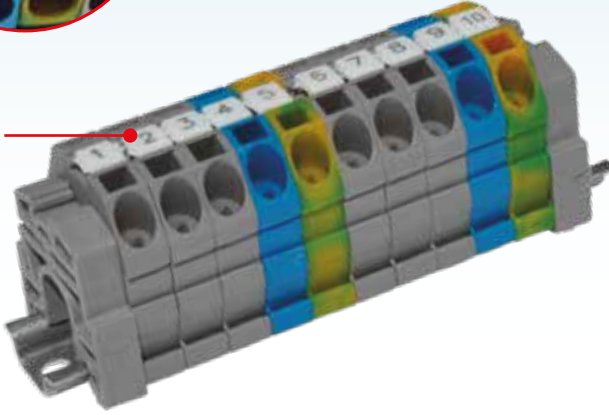

PUSH IN

MPK & MP SERİSİ

Yay Bağlantılı Mini Ray Klemensler

MPK raya montaj mini yay bağlantılı klemensler birleştirilmiş yapısıyla kullanıcıya bir çok fayda sağlamaktadır. OPK klemens grubunun küçültülmüş versiyonu olarak dizayn edilmiştir. Mini yay bağlantılı klemensler, OPK serisi ile aynı özellikleri taşımaktadır. Yüksüklü ve yüksüksüz kabloların sadece ileri itilmesiyle başka herhangi bir alete ihtiyaç duyulmadan kolayca montaj imkanı sağlar.

Küçük kompakt yapısı sayesinde pano ve bağlantı kutuları içinde kullanıcıya alan kazandırarak ergonomik tasarımlar yaratır.

MPK Klemens serisi, 15 x 5,5 mm raya ve farklı sonlandırma plaka alternatifleriyle düz zemin üzerine monte edilebilir.

Mini Yay bağlantılı Klemenslerin kontak kısmı bakır üzerine kalay kaplamadan oluşmaktadır. Paslanmaz çelik, krom ve nikel alaşımından üretilmiş yay, kablo üzerine baskı uygular. Su, Asit ve yüksek ısı içeren atmosfer koşullarına karşı yüksek dayanım göstererek okside olmaz. Mini yay bağlantılı klemenslerin yapısı, buatların içinde kullanıma olanak sağlar. Ürünün dışı, izole plastik gövdesi sayesinde, patlayıcıların ve gazların bulunduğu alanlarda da güvenle kullanımına olanak sağlar. MPK Klemens serisi bir çok renk alternatifine sahiptir.

Bu ürünün en dikkat çekici özelliklerinden biri de, numaralandırma içermesi ve 2'li, 3lü, 4'lü ve talebe bağlı daha fazla modüllerde dizayn edilebilmesidir. Bütün terminallerin birbirine eş potansiyel köprülenebilme özelliği sayesinde, dağıtım ve dengeleme barası şeklinde kullanım imkanı da sağlarken düşük bağlantı empedanslı ideal buat uygulamaları yapılabilir. Bu ürün nötr dağıtım ve topraklama işlerinde yoğun olarak kullanılır. MPK klemens serisinin markalamasında piyasada yaygın olarak tercih edilen 5x5 mm dekafixler ve 4,9 mm şerit etiketler kullanılmaktadır. Ürünün yay bağlantılı olması vibrasyonlu ortamlarda da güvenle kullanılmasına olanak sağlamaktadır.

MONTAJA UYGUN RAY ÇEŞİTLERİ

YENİ KOD	ESKİ KOD
1100109	ONKA-4246
1100110	ONKA-4247
1100111	ONKA-4248
1100114	ONKA-4251
1100115	ONKA-4252
1100116	ONKA-4253

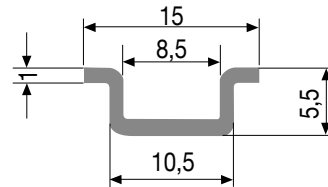

MPK SERİSİ MİNİ YAY BAĞLANTILI KLEMENSLER (PUSH-IN HER İKİ TARAFI KAPALI SİSTEM)

cinsi	GERİLİM / AKIM (V/A)	KUTU ADEDİ	RENK	YENİ KOD	ESKİ KOD	ADET (t)
MPK 2,5 mm ²	750 V / 24 A	100		1020305	ONKA-1421	8,72
				1020306	ONKA-1422	
		1020307	ONKA-1423			
		1020308	ONKA-1424			
		1020309	ONKA-1425			
		1020310	ONKA-1426			
		1020311	ONKA-1427			
		1020312	ONKA-1428			
		1020313	ONKA-1429			

MPK SERİSİ MİNİ YAY BAĞLANTILI TOPRAKLI KLEMENSLER (PUSH-IN HER İKİ TARAFI KAPALI SİSTEM)

cinsi	GERİLİM / AKIM (V/A)	KUTU ADEDİ	RENK	YENİ KOD	ESKİ KOD	ADET (t)
MPK 2,5 mm ²	750 V / 24 A	100		1020335	ONKA-1470	9,96
						

MPK SERİSİ DURDURUCU (MİNİ DURDURUCU)

cinsi	KUTU ADEDİ	RENK	YENİ KOD	ESKİ KOD	ADET (t)
MPK Serisi Durdurucu	100		1060083	ONKA-1471	8,06
			1060084	ONKA-1472	
		1060085	ONKA-1473		
		1060086	ONKA-1474		
		1060087	ONKA-1475		
		1060088	ONKA-1476		
		1060089	ONKA-1477		
		1060090	ONKA-1478		
		1060091	ONKA-1479		

MONTAJA UYGUN RAY ÇEŞİTLERİ

YENİ KOD	ESKİ KOD
1100109	ONKA-4246
1100110	ONKA-4247
1100111	ONKA-4248
1100114	ONKA-4251
1100115	ONKA-4252
1100116	ONKA-4253

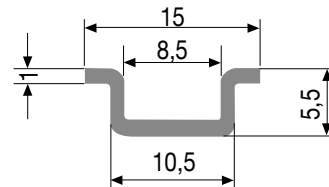

MP SERİSİ MİNİ YAY BAĞLANTILI KLEMENSLER (PUSH-IN SİSTEM)

cinsi	GERİLİM / AKIM (V/A)	KUTU ADEDİ	RENK	YENİ KOD	ESKİ KOD	ADET (t)
MP 2,5 mm ²	750 V / 24 A	100		1020326	ONKA-1461	9,14
				1020327	ONKA-1462	
				1020328	ONKA-1463	
				1020329	ONKA-1464	
				1020330	ONKA-1465	
				1020331	ONKA-1466	
				1020332	ONKA-1467	
				1020333	ONKA-1468	
				1020334	ONKA-1469	



MP SERİSİ MİNİ YAY BAĞLANTILI KLEMENSLER (İÇTEN KÖPRÜLÜ) X KLEMENS ADEDİ

cinsi	GERİLİM / AKIM (V/A)	KUTU ADEDİ	RENK	YENİ KOD	ESKİ KOD	ADET (t)
MP 2,5 mm ²	750 V / 24 A	100		1020314	ONKA-1431	9,14
				1020315	ONKA-1432	
				1020316	ONKA-1433	
				1020317	ONKA-1434	
				1020318	ONKA-1435	
				1020319	ONKA-1436	
				1020320	ONKA-1437	
				1020321	ONKA-1438	
				1020322	ONKA-1439	

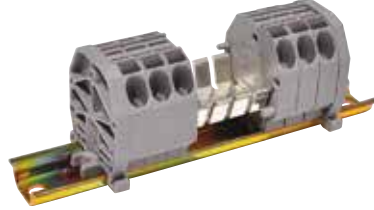

*Set içindeki KÖPRÜLENEN KLEMENS adedi ile fiyatlandırılır.

MP SERİSİ DURDURUCU VE SONLANDIRICI

cinsi	KUTU ADEDİ	RENK	YENİ KOD	ESKİ KOD	ADET (t)
Durdurucu ve Sonlandırıcı Raya Takılabilir ve Zemine Vidalanabilir.	100		1060034	ONKA-1442	2,38
Durdurucu ve Sonlandırıcı Zemine Geçmeli.	100		1060043	ONKA-1452	2,38



MONTAJA UYGUN RAY ÇEŞİTLERİ

YENİ KOD	ESKİ KOD
1100109	ONKA-4246
1100110	ONKA-4247
1100111	ONKA-4248
1100114	ONKA-4251
1100115	ONKA-4252
1100116	ONKA-4253

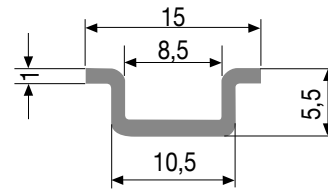



TAMAMLANAN PROJE ÇÖZÜMLERİMİZDEN ÖRNEKLER



İZMİR ŞEHİR HASTANESİ
ADANA ŞEHİR HASTANESİ
YATAĞAN DEVLET HASTANESİ
BÜNYAN DEVLET HASTANESİ
ÇAN DEVLET HASTANESİ
GÖKYOL DEVLET HASTANESİ



EGE ÜNİVERSİTESİ
RTE ÜNİVERSİTESİ
KOCAELİ ÜNİVERSİTESİ
DİCLE ÜNİVERSİTESİ
AKDENİZ ÜNİVERSİTESİ
BALIKESİR ÜNİVERSİTESİ
BURDUR ÜNİVERSİTESİ



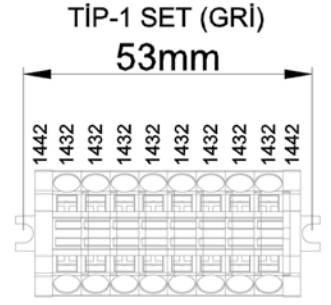
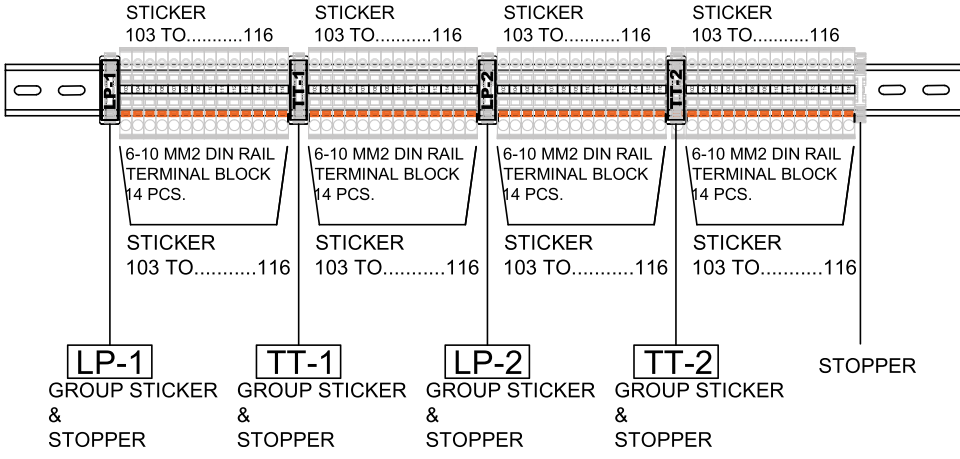

HYBRIT TYPE TERMINAL BLOCK
PUSH-IN TO SCREW CONNECTION

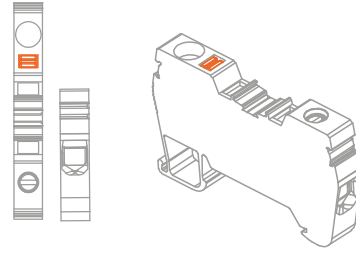
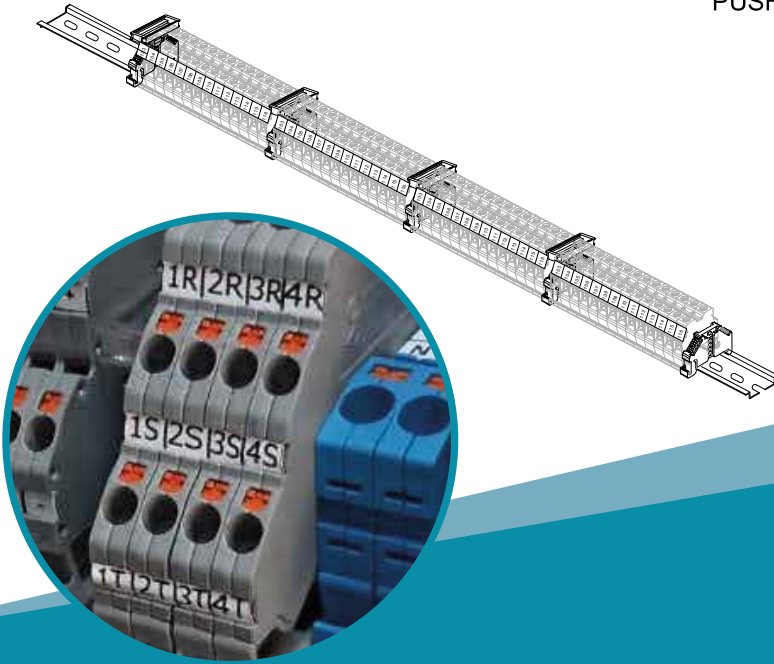

PROJE ve UYGULAMALARINIZA ÖZEL SET TASARIM ve ÇÖZÜMLERİ

- ✓ Yatırım ve Uygulama Süreçlerinde Düşük Maliyet
- ✓ Standartizasyon Sayesinde Kurulum ve İşletme Hatalarının Minimize Edilmesi
- ✓ Geniş Renk Seçeneği ve Markalama Yapısıyla Daha Doğru , Daha Hızlı Uygulama
- ✓ Daha Düşük Bağlantı Empedansı ile Daha Az Kayıp, Daha Yüksek İş

Gelişen teknoloji ile birlikte doğan özel ihtiyaçların karşılanmasına yönelik; kompakt, estetik, işletme ömrü boyunca tesisi yöneten teknik personelin binlerce düğüm noktası arasında sağlıklı ve kontrollü işlem yapabileceği, her açıdan sürdürülebilir kalite sağlayacak optimum bağlantı tasarımları sunuyoruz.

Standardizasyon
gerekiren yapı ve sistemler
için proje grubumuzla geliştirdiğimiz
bağlantı çözümlerimiz ve hazır set
tasarımlarımızla teknik ve
ekonomik avantajlar
sağlıyoruz.

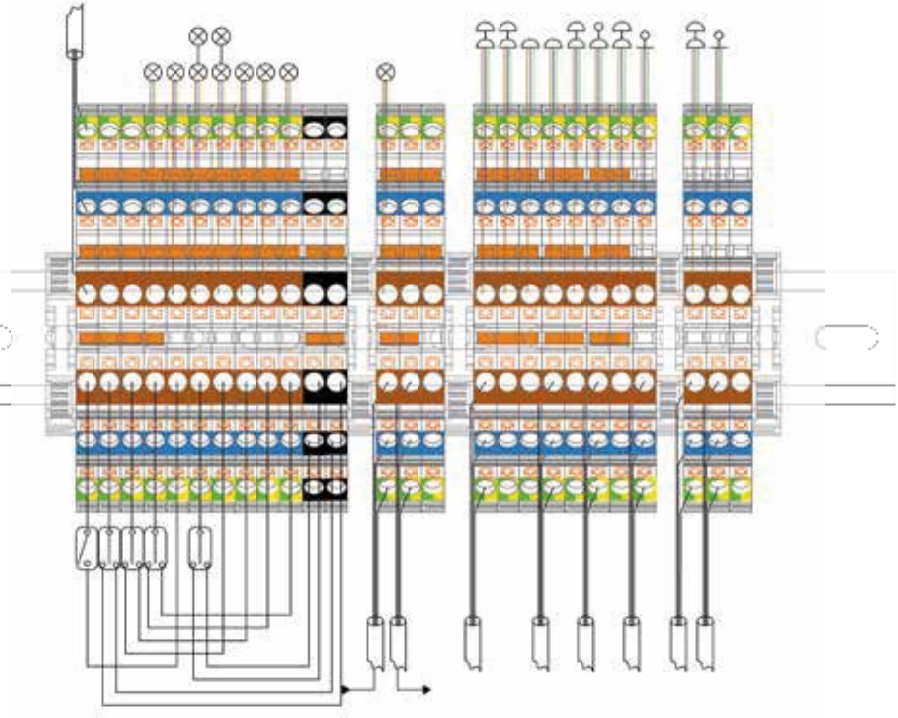
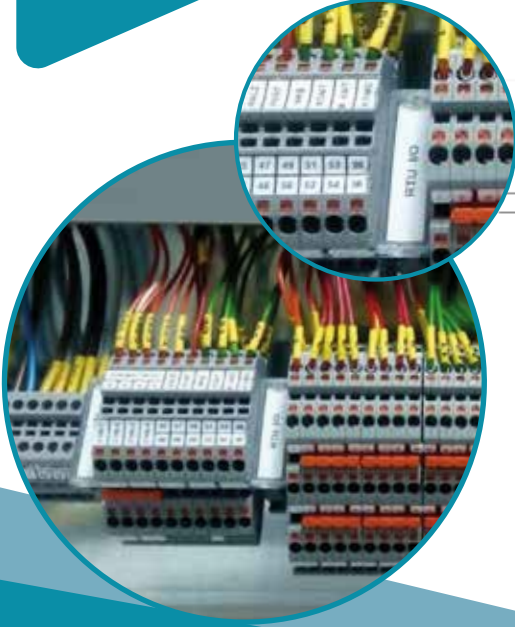

KULLANIM ALANLARI

- ✓ YURLAR
- ✓ OKULLAR
- ✓ HASTANELER
- ✓ ARITMA TESİSLERİ
- ✓ SAVUNMA SANAYİİ
- ✓ BİLGİ İŞLEM MERKEZLERİ
- ✓ TRAFİK YÖNETİM SİSTEMLERİ
- ✓ ENERJİ ÜRETİM/İLETİM/DAĞITIM TESİSLERİ
- ✓ AKILLI BİNA OTOMASYONU VE HVAC SİSTEMLERİ
- ✓ MAKİNE , ASANSÖR , VİNÇ , EKİPMAN SERİ ÜRÜNLERİ

Bilgi ve teknik destek için satış/pazarlama birimlerimizle irtibata geçiniz.

YENİ NESİL ENDÜSTRİYEL MARKALAMA



TERMAL TRANSFER YÖNTEM İLE YAPILAN MARKALAMA İŞLEMLERİNİZ İÇİN;



DAHA PRATİK



DAHA HIZLI



DAHA EKONOMİK

MARKALAMA
ÇÖZÜMLERİMİZLE
TANIŞMAYA
NE DERSİNİZ

- Kolay kurulum
- Tüm Windows sürümleriyle uyumlu
- Online versiyon ile kurulumuz çalışır ve web üzerinden tasarım + baskı
- Gelişmiş tasarım araçları ile; yazı – çizim – resim ve seriler oluşturma
- Oluşturduğunuz proje ve şablonlarınızı kaydetme veya taşıma
- Farklı dosya formatlarını destekleme (.xls, .jpeg, .png)
- Microsoft Office araçları ile Import&Export seçenekleri

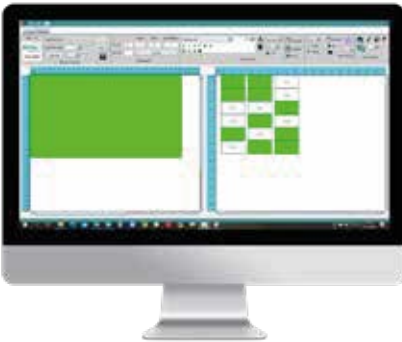

İHTİYACA YÖNELİK ÇÖZÜMLER

- Pano etiketleri
- Komponent etiketleri
- Kablo etiketleri
- Cihaz ve makina etiketleri
- Klemens markalama çözümleri
- Özel ihtiyaçlara yönelik çözümler



**TEK YAZICI VE YAZILIMLA
ZAMANINIZ VE ENERJİNİZ SİZE KALSIN...**

Detaylı bilgi ve demo sürümü için;

www.**Onka**.com.tr

ve satış temsilcilerimizle iletişime geçiniz.



ONKA-8912-AX

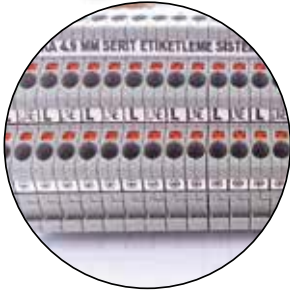

4,9mm X 5 X 20 mt
Şerit Etiket



Isı büzümeli makarona
ONKA-8944-70
ribon ile baskı



2x20 Metre
Toplam Şerit Uzunluğu **40 metre**

40 metrelik şerit ile yaklaşık;
7.500 adet 1,5 mm² lik,
6.500 adet 2,5 mm² lik,
5.500 adet 4 mm² lik,
4.500 adet 6 mm² lik,
4.000 adet 10 mm² lik
klemens etiketlenebilmektedir.



ONKA-8944-55



ONKA-8944-110



ONKA-8943-S11

MARKALAMA SİSTEMLERİ

KLEMENSLER İÇİN ŞERİT MARKALAMA SİSTEMİ

ÜRÜN KODU	AÇIKLAMA	ADET (€)	KUTU ADEDİ
ONKA-8912-AX	ARGOX CP2140 Termal Yazıcı	☎	1
ONKA-8944-55	55 mm X 300 mt Siyah Ribon (Şerit Etiketler için)	52,50 €	300 MT
ONKA-8944-70	70 mm X 300 mt Siyah Ribon - PR (Makaron ve Şeffaf Tüp Etiketleri)	65,00 €	300 MT
ONKA-8944-110	110 mm x 300 mt Siyah Ribon	130,00 €	300 MT
ONKA-8943-S11	11 mm X 2 X 20 mt Duple Şerit Etiket (Beyaz) ⇨	29,00 €	40 MT
ONKA-8943-S11S	11 mm X 2 X 20 mt Duple Şerit Etiket (Sarı) ⇨	30,00 €	40 MT
ONKA-8843-S4.9	4,9 mm X 5 X 20 mt Şerit Etiket	28,00 €	100 MT

KOMPONENT ETİKETLERİ



ÜRÜN KODU	RENK	AÇIKLAMA	RULO (€)	SÜTUN SAYISI	RULO ADEDİ
ONKA-8920-515SE	→	5x15 mm Sarı Komponent Etiketi (EKO)	50,00 €	5	5000 ADET
ONKA-8920-515S	→	5x15 mm Sarı Komponent Etiketi	100,00 €	5	5000 ADET
ONKA-8920-515B	⇨	5x15 mm Beyaz Komponent Etiketi	100,00 €	5	5000 ADET
ONKA-8920-915SV	→	9x15 mm Sarı Komponent Etiketi	150,00 €	5	5000 ADET
ONKA-8920-915SBR	→	15x9 mm Sarı Komponent Etiketi	310,00 €	5	5000 ADET
ONKA-8920-716S	→	16x7 mm Sarı Komponent Etiketi	310,00 €	5	5000 ADET
ONKA-8920-915SE	→	9x15 mm Sarı Komponent Etiketi (EKO)	60,00 €	5	5000 ADET
ONKA-8920-915BE	⇨	9x15 mm BEYAZ Komponent Etiketi (EKO)	60,00 €	5	5000 ADET
ONKA-8920-915SG	→	9x15 mm Gümüş Gri Komponent Etiketi	70,00 €	5	2500 ADET
ONKA-8920-516S	→	5x16,5 mm Sarı Komponent Etiketi	170,00 €	5	5000 ADET
ONKA-8920-930S	→	9x30 mm Sarı Komponent Etiketi	110,00 €	3	1500 ADET
ONKA-8920-912SE	→	9x12 mm Sarı Komponent Etiketi (EKO)	42,00 €	5	2500 ADET
ONKA-8920-736SE	→	7x36 mm Sarı Komponent Etiketi (EKO)	42,00 €	1	1000 ADET
ONKA-8920-736BE	⇨	7x36 mm Beyaz Komponent Etiketi (EKO)	42,00 €	1	1000 ADET
ONKA-8920-2015S	→	20 mm x 15 mt Sarı Genel Amaçlı Şerit Etiket	21,00 €	1	15 MT
ONKA-8920-1550B	⇨	15 mm x 50 mt Beyaz Genel Amaçlı Şerit Etiket	35,00 €	1	50 MT
ONKA-8920-1550S	→	15 mm x 50 mt Sarı Genel Amaçlı Şerit Etiket	35,00 €	1	50 MT
ONKA-8920-1550K	→	15 mm x 50 mt Kırmızı Genel Amaçlı Şerit Etiket	35,00 €	1	50 MT
ONKA-8920-1550G	→	15 mm x 50 mt Gümüş Gri Genel Amaçlı Şerit Etiket	35,00 €	1	50 MT
ONKA-8920-2050B	⇨	20 mm x 50 mt Beyaz Genel Amaçlı Şerit Etiket	47,00 €	1	50 MT
ONKA-8920-2050S	→	20 mm x 50 mt Sarı Genel Amaçlı Şerit Etiket	47,00 €	1	50 MT
ONKA-8920-2050K	→	20 mm x 50 mt Kırmızı Genel Amaçlı Şerit Etiket	47,00 €	1	50 MT
ONKA-8920-2050G	→	20 mm x 50 mt Gümüş Gri Genel Amaçlı Şerit Etiket	47,00 €	1	50 MT
ONKA-8920-3050B	⇨	30 mm x 50 mt Beyaz Genel Amaçlı Şerit Etiket	70,00 €	1	50 MT
ONKA-8920-3050S	→	30 mm x 50 mt Sarı Genel Amaçlı Şerit Etiket	70,00 €	1	50 MT
ONKA-8920-3050K	→	30 mm x 50 mt Kırmızı Genel Amaçlı Şerit Etiket	70,00 €	1	50 MT
ONKA-8920-3050G	→	30 mm x 50 mt Gümüş Gri Genel Amaçlı Şerit Etiket	70,00 €	1	50 MT
ONKA-8920-5050B	⇨	50 mm x 50 mt Beyaz Genel Amaçlı Şerit Etiket	117,00 €	1	50 MT
ONKA-8920-5050S	→	50 mm x 50 mt Sarı Genel Amaçlı Şerit Etiket	117,00 €	1	50 MT
ONKA-8920-5050K	→	50 mm x 50 mt Kırmızı Genel Amaçlı Şerit Etiket	117,00 €	1	50 MT
ONKA-8920-5050G	→	50 mm x 50 mt Gümüş Gri Genel Amaçlı Şerit Etiket	117,00 €	1	50 MT



İNCE PANO ETİKETLERİ

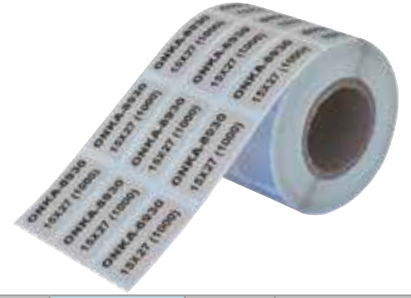

ÜRÜN KODU	RENK	AÇIKLAMA	RULO (€)	SÜTUN SAYISI	RULO ADEDİ
ONKA-8921-80100SW	⇒	80x100 mm Silvermat İnce Pano Etiketi (EKO)	135,00 €	1	100 ADET
ONKA-8921-5075SW	⇒	50x75 mm Silvermat İnce Pano Etiketi (EKO)	250,00 €	1	1000 ADET
ONKA-8921-2575SW	⇒	25x75 mm Silvermat İnce Pano Etiketi (EKO)	265,00 €	1	2000 ADET
ONKA-8921-1326SW	⇒	13x26 mm Silvermat İnce Pano Etiketi (EKO)	90,00 €	3	1500 ADET
ONKA-8921-40100SW	⇒	40x100 mm Silvermat İnce Pano Etiketi (EKO)	190,00 €	1	500 ADET
ONKA-8921-1545SW	⇒	15x45 mm Silvermat İnce Pano Etiketi (EKO)	60,00 €	1	1000 ADET
ONKA-8921-1527SW	⇒	15x27 mm Silvermat İnce Pano Etiketi (EKO)	48,00 €	1	1000 ADET
ONKA-8921-50100SW	⇒	50x100 mm Silvermat İnce Pano Etiketi (EKO)	240,00 €	1	1000 ADET

ORTA KALIN PANO ETİKETLERİ



ÜRÜN KODU	RENK	AÇIKLAMA	RULO (€)	SÜTUN SAYISI	RULO ADEDİ
ONKA-8923-1545OG	⇒	15X45 mm Orta Kalın Pano Etiketi Gümüş Gri	265,00 €	1	1000 ADET
ONKA-8923-1527OG	⇒	15X27 mm Orta Kalın Pano Etiketi Gümüş Gri	230,00 €	3	1500 ADET
ONKA-8923-50100OG	⇒	50X100 mm Orta Kalın Pano Etiketi Gümüş Gri	385,00 €	1	250 ADET
ONKA-8923-3065OG	⇒	30X65 mm Orta Kalın Pano Etiketi Gümüş Gri	333,00 €	1	500 ADET
ONKA-8923-1545OB	⇒	15X45 mm Orta Kalın Pano Etiketi Beyaz	160,00 €	1	500 ADET
ONKA-8923-1545OK	⇒	15X45 mm Orta Kalın Pano Etiketi Kırmızı	160,00 €	1	500 ADET
ONKA-8923-1545OS	⇒	15X45 mm Orta Kalın Pano Etiketi Sarı	160,00 €	1	500 ADET
ONKA-8923-1527OS	⇒	15X27 mm Orta Kalın Pano Etiketi Sarı	130,00 €	1	500 ADET
ONKA-8923-1527OB	⇒	15X27 mm Orta Kalın Pano Etiketi Beyaz	130,00 €	1	500 ADET
ONKA-8923-1527OK	⇒	15X27 mm Orta Kalın Pano Etiketi Kırmızı	130,00 €	1	750 ADET
ONKA-8923-3065OK	⇒	30X65 mm Orta Kalın Pano Etiketi Kırmızı	210,00 €	1	250 ADET
ONKA-8923-3065OB	⇒	30X65 mm Orta Kalın Pano Etiketi Beyaz	210,00 €	1	250 ADET
ONKA-8923-3065OS	⇒	30X65 mm Orta Kalın Pano Etiketi Sarı	210,00 €	1	250 ADET
ONKA-8923-50100OB	⇒	50X100 mm Orta Kalın Pano Etiketi Beyaz	385,00 €	1	250 ADET
ONKA-8923-50100OK	⇒	50X100 mm Orta Kalın Pano Etiketi Kırmızı	385,00 €	1	250 ADET
ONKA-8923-50100OS	⇒	50X100 mm Orta Kalın Pano Etiketi Sarı	385,00 €	1	250 ADET
Onka-8923-1827OG	⇒	18X27 mm Orta Kalın Pano Etiketi Gümüş Gri	160,00 €	1	500 ADET
Onka-8923-1827OB	⇒	18X27 mm Orta Kalın Pano Etiketi Beyaz	160,00 €	1	500 ADET
Onka-8923-1827OK	⇒	18X27 mm Orta Kalın Pano Etiketi Kırmızı	160,00 €	1	500 ADET
Onka-8923-1827OS	⇒	18X27 mm Orta Kalın Pano Etiketi Sarı	160,00 €	1	500 ADET



*ONKA-8944-110 ribon ile kullanılır.

KALIN PANO ETİKETLERİ



ÜRÜN KODU	RENK	AÇIKLAMA	RULO (€)	SÜTUN SAYISI	RULO ADEDİ
ONKA-8922-1227P	⇒	12,5x27 mm Gri Kalın Pano Etiketi	140,00 €	1	200 ADET
ONKA-8922-1545P	⇒	15x45 mm Gri Kalın Pano Etiketi	120,00 €	1	125 ADET
ONKA-8922-1527P	⇒	15x27 mm Gri Kalın Pano Etiketi	64,00 €	1	150 ADET
ONKA-8922-1827P	⇒	18x27 mm Gri Kalın Pano Etiketi	64,00 €	1	150 ADET
ONKA-8922-1835P	⇒	18x35 mm Gri Kalın Pano Etiketi	95,00 €	1	125 ADET
ONKA-8922-3040P	⇒	30x40 mm Gri Kalın Pano Etiketi (Buton Rozeti)	80,00 €	1	100 ADET
ONKA-8922-3060P	⇒	30x60 mm Gri Kalın Pano Etiketi	200,00 €	1	125 ADET
ONKA-8922-4590P	⇒	45x90 mm Gri Kalın Pano Etiketi	335,00 €	1	100 ADET

KABLOLAMA ÇÖZÜMLERİ (SARMAL KABLO ETİKETLERİ)



ÜRÜN KODU	RENK	AÇIKLAMA	RULO (€)	SÜTUN SAYISI	RULO ADEDİ
ONKA-8924-1510B	⇒	15x10 mm (1.5-2.5-4-6-10mm ²) Sarmal Kablo Etiketi BEYAZ	100,00 €	4	1000 ADET
ONKA-8924-1915B	⇒	19x15 mm (1.5-2.5-4-6 mm ²) Sarmal Kablo Etiketi BEYAZ	160,00 €	4	2000 ADET
ONKA-8924-1925B	⇒	19x25 mm (10-16 mm ²) Sarmal Kablo Etiketi BEYAZ	210,00 €	3	1500 ADET
ONKA-8924-1938B	⇒	19x38 mm (25-35-50 mm ²) Sarmal Kablo Etiketi BEYAZ	245,00 €	2	2000 ADET
ONKA-8924-1915S	⇒	19x15 mm (1.5-2.5-4-6 mm ²) Sarmal Kablo Etiketi SARI	150,00 €	4	2000 ADET
ONKA-8924-1925S	⇒	19x25 mm (10 -16 mm ²) Sarmal Kablo Etiketi SARI	250,00 €	3	1500 ADET
ONKA-8924-1938S	⇒	19x38 mm (25-35-50 mm ²) Sarmal Kablo Etiketi SARI	280,00 €	2	2000 ADET
ONKA-8924-38180S	⇒	38x180 mm Sarmal Kablo Etiketi SARI	260,00 €	2	720 ADET



KABLOLAMA ÇÖZÜMLERİ (ŞEFFAF TÜP ETİKETLERİ)

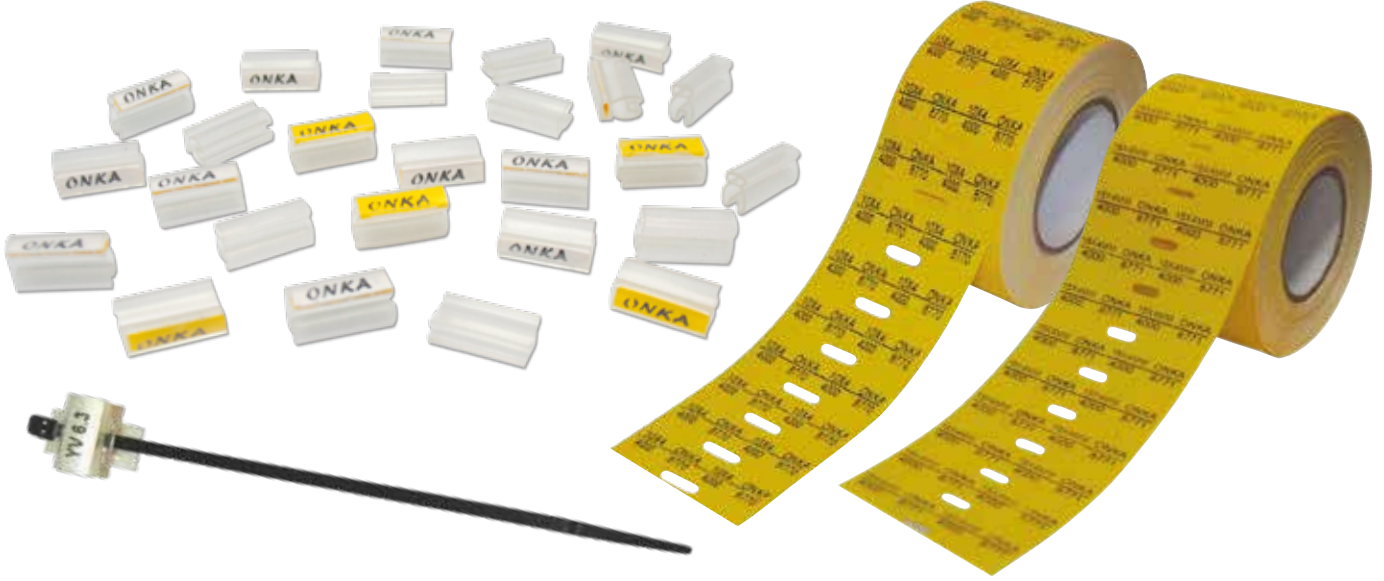

ÜRÜN KODU	RENK	AÇIKLAMA	RULO (€)	SÜTUN SAYISI	RULO ADEDİ
ONKA-8925-104B	⇒	10x4 mm Şeffaf Tüp Etiketi - BEYAZ	190,00 €	4	4000 ADET
ONKA-8925-154B	⇒	15x4 mm Şeffaf Tüp Etiketi - BEYAZ	210,00 €	4	4000 ADET
ONKA-8925-204B	⇒	20x4 mm Şeffaf Tüp Etiketi - BEYAZ	210,00 €	2	3000 ADET
ONKA-8925-304B	⇒	30x4 mm Şeffaf Tüp Etiketi - BEYAZ	230,00 €	2	2500 ADET
ONKA-8925-104S	⇒	10x4 mm Şeffaf Tüp Etiketi - SARI	190,00 €	4	4000 ADET
ONKA-8925-154S	⇒	15x4 mm Şeffaf Tüp Etiketi - SARI	210,00 €	4	4000 ADET
ONKA-8925-204S	⇒	20x4 mm Şeffaf Tüp Etiketi - SARI	210,00 €	2	3000 ADET
ONKA-8925-304S	⇒	30x4 mm Şeffaf Tüp Etiketi - SARI	230,00 €	2	2500 ADET

KABLOLAMA ÇÖZÜMLERİ (ŞEFFAF TÜPLER)

ÜRÜN KODU	AÇIKLAMA	KUTU (€)	KUTU ADEDİ
ONKA-8926-101	10 mm Şeffaf Tüp / 0,5-1,5 mm ² Kablo için	70,00 €	1000 ADET
ONKA-8926-151	15 mm Şeffaf Tüp / 0,5-1,5 mm ² Kablo için	100,00 €	1000 ADET
ONKA-8926-201	20 mm Şeffaf Tüp / 0,5-1,5 mm ² Kablo için	70,00 €	500 ADET
ONKA-8926-301	30 mm Şeffaf Tüp / 0,5-1,5 mm ² Kablo için	100,00 €	500 ADET
ONKA-8926-102	10 mm Şeffaf Tüp / 2,5-4 mm ² Kablo için	80,00 €	1000 ADET
ONKA-8926-152	15 mm Şeffaf Tüp / 2,5-4 mm ² Kablo için	120,00 €	1000 ADET
ONKA-8926-202	20 mm Şeffaf Tüp / 2,5-4 mm ² Kablo için	80,00 €	500 ADET
ONKA-8926-302	30 mm Şeffaf Tüp / 2,5-4 mm ² Kablo için	120,00 €	500 ADET
ONKA-8926-103	10 mm Şeffaf Tüp / 4-6 mm ² Kablo için	105,00 €	1000 ADET
ONKA-8926-153	15 mm Şeffaf Tüp / 4-6 mm ² Kablo için	125,00 €	1000 ADET
ONKA-8926-203	20 mm Şeffaf Tüp / 4-6 mm ² Kablo için	85,00 €	500 ADET
ONKA-8926-303	30 mm Şeffaf Tüp / 4-6 mm ² Kablo için	125,00 €	500 ADET
ONKA-8926-420	20x4 mm Şeffaf Tüp / Kablo Bağlı (Genel Amaçlı)	Ⓢ	1000 ADET



*ONKA-8944-70 ribon ile kullanılır.

HAZIR İKAZ ETİKETLERİ VE ÖLÜM TEHLİKE LEVHALARI

	ÜRÜN KODU	CİNSİ	ADET (t)	PLAKA ADEDİ
	ONKA-2473	25 mm Üçgen Etiket (DİKKAT)	4,95 €	1 PLAKA (132 ADET)
	ONKA-2474	25 mm Üçgen Etiket (NÖTR)	4,95 €	1 PLAKA (132 ADET)
	ONKA-2477	25 mm Üçgen Etiket (TOPRAK)	4,95 €	1 PLAKA (132 ADET)
	ONKA-2478	25 mm Üçgen Etiket (FAZ)	4,95 €	1 PLAKA 44 TAKIM (132 ADET)
	ONKA-8922-1310SY	PVC Hazır Üçgen Uyarı Etiketi Yapışkanlı 13x10 cm	210,00 €	100 ADET
	ONKA-8922-118SY	PVC Hazır Üçgen Uyarı Etiketi Yapışkanlı 11x8 cm	175,00 €	100 ADET
	ONKA-8922-2315SY	PVC Hazır Uyarı Etiketi Yapışkanlı 23x15 cm (Ölüm Tehlike Levhası)	420,00 €	100 ADET
	ONKA-8922-2315S	PVC Hazır Uyarı Etiketi 23x15 cm (Ölüm Tehlike Levhası)	350,00 €	100 ADET

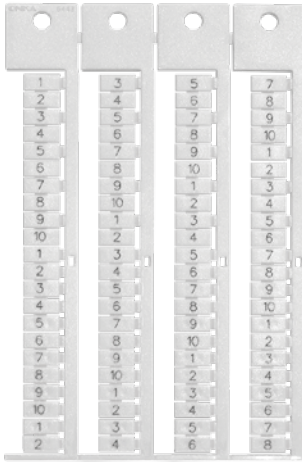
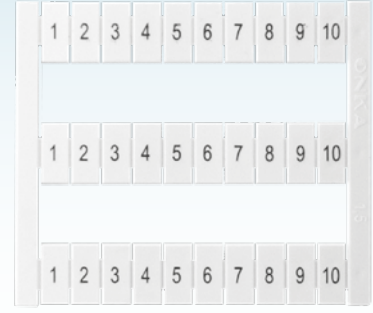

DEKAFİXLER

DEKAFİXLER (MRK ve OPK SERİSİ)

YENİ KOD	ESKİ KOD	AÇIKLAMA	ADET (t)	KUTU ADEDİ
1060198	ONKA-5443	OD10-5P Baskısız, Birleşik Kopan (1,5 mm ² klemens için)	0,39	880
1060199	ONKA-5444	OD10-5P Baskılı, Birleşik Kopan (1,5 mm ² klemens için)	0,78	880
1060192	ONKA-4440	OD10-6P Baskısız Birleşik Kopan (2,5 mm ² klemens için)	0,67	720
1060193	ONKA-4441	OD10-6P Baskılı Birleşik Kopan (2,5 mm ² klemens için)	1,05	720
1060194	ONKA-4442	OD10-6P Baskısız Tek Tek Kopan	0,67	720
1060195	ONKA-4443	OD10-6P Baskılı Tek Tek Kopan	1,05	720
1060190	ONKA-4390	OD10-6P Baskısız, Birleşik Kopan (4 mm ² klemens için)	0,51	640
1060197	ONKA-4391	OD10-6P Baskılı, Birleşik Kopan (4 mm ² klemens için)	0,89	640
1060188	ONKA-2630	OD10-8P Baskısız, Birleşik Kopan (6 -10 mm ² ve üzeri klemens için)	0,60	560
1060189	ONKA-2631	OD10-8P Baskılı, Birleşik Kopan (6 -10 mm ² ve üzeri klemens için)	0,99	560

DEKAFİX (MRK ve OPK SERİSİ)
OD5-5

ÜRÜN KODU	BASKI	ADET (t)
1060200	BASKISIZ	0,32
1060201	ÖZEL BASKILI	0,48
1060212	0	0,40
1060213	1	0,40
1060214	2	0,40
1060215	3	0,40
1060216	4	0,40
1060217	5	0,40
1060218	6	0,40
1060219	7	0,40
1060220	8	0,40
1060221	9	0,40
1060222	10	0,40
1060223	1-10	0,40
1060224	11-20	0,40
1060225	21-30	0,40
1060226	31-40	0,40
1060227	41-50	0,40
1060228	51-60	0,40
1060229	61-70	0,40
1060230	71-80	0,40
1060231	81-90	0,40
1060232	91-100	0,40
1060233	101-110	0,40
1060234	111-120	0,40
1060235	121-130	0,40
1060236	131-140	0,40
1060237	141-150	0,40
1060238	151-160	0,40
1060239	161-170	0,40
1060240	171-180	0,40
1060241	181-190	0,40
1060242	191-200	0,40
1060243	10,20,....,100	0,40
1060244	1-50	0,40
1060245	51-100	0,40
1060246	101-150	0,40
1060247	151-200	0,40
1060248	201-250	0,40
1060249	251-300	0,40
1060250	301-350	0,40
1060251	351-400	0,40
1060252	401-450	0,40
1060253	451-500	0,40

ÜRÜN KODU	BASKI	ADET (t)
1060254	501-550	0,40
1060255	551-600	0,40
1060256	601-650	0,40
1060257	651-700	0,40
1060258	701-750	0,40
1060259	751-800	0,40
1060260	801-850	0,40
1060261	851-900	0,40
1060262	901-950	0,40
1060263	951-999	0,40
1060264	+	0,40
1060265	-	0,40
1060266	⊕	0,40
1060267	Mp	0,40
1060268	PE	0,40
1060269	L1	0,40
1060270	L2	0,40
1060271	L3	0,40
1060272	A	0,40
1060273	B	0,40
1060274	C	0,40
1060275	D	0,40
1060276	E	0,40
1060277	F	0,40
1060278	G	0,40
1060279	H	0,40
1060280	I	0,40
1060281	J	0,40
1060282	K	0,40
1060283	L	0,40
1060284	M	0,40
1060285	N	0,40
1060286	O	0,40
1060287	P	0,40
1060288	Q	0,40
1060289	R	0,40
1060290	S	0,40
1060291	T	0,40
1060292	U	0,40
1060293	V	0,40
1060294	W	0,40
1060295	X	0,40
1060296	Y	0,40
1060297	Z	0,40

DEKAFİX (MRK ve OPK SERİSİ)
OD10 (1,5 mm²)

ÜRÜN KODU	BASKI	ADET (t)
1060298	BASKISIZ	0,47
1060508	ÖZEL BASKILI	0,73
1060299	0	0,61
1060300	1	0,61
1060301	2	0,61
1060302	3	0,61
1060303	4	0,61
1060304	5	0,61
1060305	6	0,61
1060306	7	0,61
1060307	8	0,61
1060308	9	0,61
1060309	10	0,61
1060310	1-10	0,61
1060311	11-20	0,61
1060312	21-30	0,61
1060313	31-40	0,61
1060314	41-50	0,61
1060315	51-60	0,61
1060316	61-70	0,61
1060317	71-80	0,61
1060318	81-90	0,61
1060319	91-100	0,61
1060320	101-110	0,61
1060321	111-120	0,61
1060322	121-130	0,61
1060323	131-140	0,61
1060324	141-150	0,61
1060325	151-160	0,61
1060326	161-170	0,61
1060327	171-180	0,61
1060328	181-190	0,61
1060329	191-200	0,61
1060330	10,20,....,100	0,61

ÜRÜN KODU	BASKI	ADET (t)
1060331	+	0,61
1060332	-	0,61
1060333	⊕	0,61
1060334	Mp	0,61
1060335	PE	0,61
1060336	L1	0,61
1060337	L2	0,61
1060338	L3	0,61
1060339	A	0,61
1060340	B	0,61
1060341	C	0,61
1060342	D	0,61
1060343	E	0,61
1060344	F	0,61
1060345	G	0,61
1060346	H	0,61
1060347	I	0,61
1060348	J	0,61
1060349	K	0,61
1060350	L	0,61
1060351	M	0,61
1060352	N	0,61
1060353	O	0,61
1060354	P	0,61
1060355	Q	0,61
1060356	R	0,61
1060357	S	0,61
1060358	T	0,61
1060359	U	0,61
1060360	V	0,61
1060361	W	0,61
1060362	X	0,61
1060363	Y	0,61
1060364	Z	0,61

DEKAFİX (MRK ve OPK SERİSİ) OD10 (2,5 mm²)

ÜRÜN KODU	BASKI	ADET (t)	ÜRÜN KODU	BASKI	ADET (t)
1060365	BASKISIZ	0,54	1060398	+	0,69
1060509	ÖZEL BASKILI	0,83	1060399	-	0,69
1060366	0	0,69	1060400	⚡	0,69
1060367	1	0,69	1060401	Mp	0,69
1060368	2	0,69	1060402	PE	0,69
1060369	3	0,69	1060403	L1	0,69
1060370	4	0,69	1060404	L2	0,69
1060371	5	0,69	1060405	L3	0,69
1060372	6	0,69	1060406	A	0,69
1060373	7	0,69	1060407	B	0,69
1060374	8	0,69	1060408	C	0,69
1060375	9	0,69	1060409	D	0,69
1060376	10	0,69	1060410	E	0,69
1060377	1-10	0,69	1060411	F	0,69
1060378	11-20	0,69	1060412	G	0,69
1060379	21-30	0,69	1060413	H	0,69
1060380	31-40	0,69	1060414	I	0,69
1060381	41-50	0,69	1060415	J	0,69
1060382	51-60	0,69	1060416	K	0,69
1060383	61-70	0,69	1060417	L	0,69
1060384	71-80	0,69	1060418	M	0,69
1060385	81-90	0,69	1060419	N	0,69
1060386	91-100	0,69	1060420	O	0,69
1060387	101-110	0,69	1060421	P	0,69
1060388	111-120	0,69	1060422	Q	0,69
1060389	121-130	0,69	1060423	R	0,69
1060390	131-140	0,69	1060424	S	0,69
1060391	141-150	0,69	1060425	T	0,69
1060392	151-160	0,69	1060426	U	0,69
1060393	161-170	0,69	1060427	V	0,69
1060394	171-180	0,69	1060428	W	0,69
1060395	181-190	0,69	1060429	X	0,69
1060396	191-200	0,69	1060430	Y	0,69
1060397	10,20,....,100	0,69	1060431	Z	0,69

* OD10 Serisi Dekafix Kutu Miktarı 300 Adettir.

DEKAFİX (MRK ve OPK SERİSİ) OD10 (4 mm²)

ÜRÜN KODU	BASKI	ADET (t)	ÜRÜN KODU	BASKI	ADET (t)
1060432	BASKISIZ	0,71	1060465	+	0,85
1060510	ÖZEL BASKILI	1,02	1060466	-	0,85
1060433	0	0,85	1060467	⚡	0,85
1060434	1	0,85	1060468	Mp	0,85
1060435	2	0,85	1060469	PE	0,85
1060436	3	0,85	1060470	L1	0,85
1060437	4	0,85	1060471	L2	0,85
1060438	5	0,85	1060472	L3	0,85
1060439	6	0,85	1060473	A	0,85
1060440	7	0,85	1060474	B	0,85
1060441	8	0,85	1060475	C	0,85
1060442	9	0,85	1060476	D	0,85
1060443	10	0,85	1060477	E	0,85
1060444	1-10	0,85	1060478	F	0,85
1060445	11-20	0,85	1060479	G	0,85
1060446	21-30	0,85	1060480	H	0,85
1060447	31-40	0,85	1060481	I	0,85
1060448	41-50	0,85	1060482	J	0,85
1060449	51-60	0,85	1060483	K	0,85
1060450	61-70	0,85	1060484	L	0,85
1060451	71-80	0,85	1060485	M	0,85
1060452	81-90	0,85	1060486	N	0,85
1060453	91-100	0,85	1060487	O	0,85
1060454	101-110	0,85	1060488	P	0,85
1060455	111-120	0,85	1060489	Q	0,85
1060456	121-130	0,85	1060490	R	0,85
1060457	131-140	0,85	1060491	S	0,85
1060458	141-150	0,85	1060492	T	0,85
1060459	151-160	0,85	1060493	U	0,85
1060460	161-170	0,85	1060494	V	0,85
1060461	171-180	0,85	1060495	W	0,85
1060462	181-190	0,85	1060496	X	0,85
1060463	191-200	0,85	1060497	Y	0,85
1060464	10,20,....,100	0,85	1060498	Z	0,85

* OD10 Serisi Dekafix Kutu Miktarı 300 Adettir.

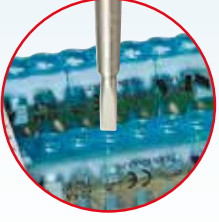

Kapak sökmeden
montaj



Kapak sökmeden
Kablo giriş



Zemine
ve raya montaj

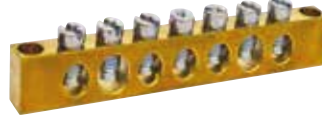
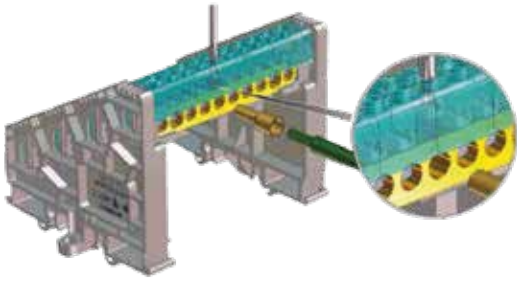
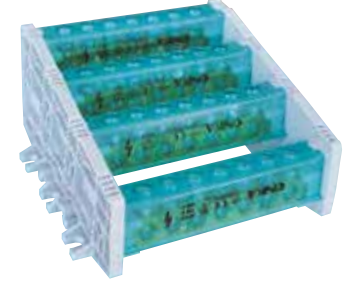
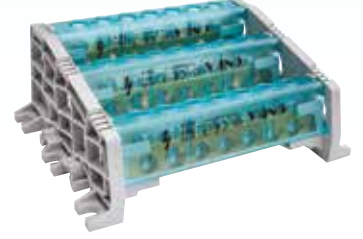
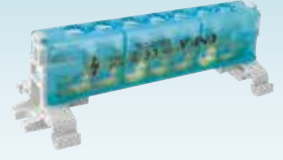

MS58

DAĞITICI ÜNİTELER

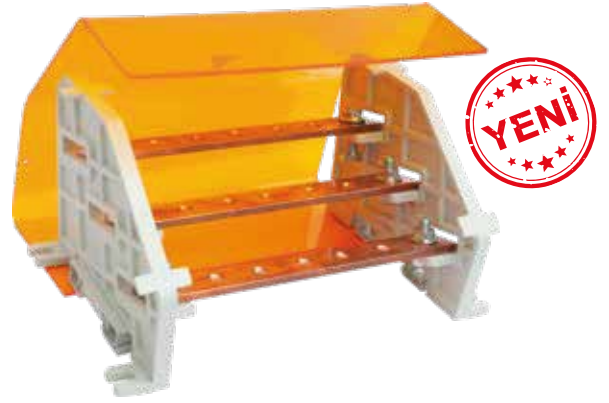

Pano ve bağlantı kutuları içinde ;

- Güvenli,
- Ergonomik
- Estetik bağlantılarla kayıpsız enerji dağıtım ve toplama.
- Yüksek kısadevre gücü ve dielektrik yapısı ile maksimum pano, tesis ve personel güvenliği.
- Yetkisiz personel ve canlılar için kazara dokunmalara karşı ekstra emniyet ve formlama kabiliyeti. (FORM-2 / FORM2-B)
- Yenilenebilir enerji sektörü AC/DC Toplama panoları için ideal kompakt çözüm, 1500V-DC gerilimi dayanımı.

TEKNİK ÖZELLİKLER

KESİT ÖLÇÜLERİ (mm)	KÜÇÜK DELİK ÇAPI (mm)	BÜYÜK DELİK ÇAPI (mm)	AKIM (A)	TEK DAMAR KABLO KESİTİ (mm ²)	ÇOK TELLİ KABLO KESİTİ (mm ²)
6,5 x 9	4,8	5,5	80	16 mm ²	10 mm ²
7 x 12	6	7,5	160	25 mm ²	25 mm ²
10 x 15	8,5	10,3	250	50 mm ²	50 mm ²

PANO TOPRAKLAMA KLEMENSLERİ

80 AMPER (A:9 x B:6,5 mm)

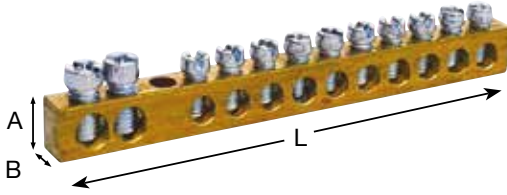

Çok Telli Kablo kesiti max. 10 mm²
Tek Damarlı Kablo kesiti max. 16 mm²

YENİ KOD	ESKİ KOD	CİNSİ	L ± 2	ADET (t)	K. AD.
1080101	ONKA - 2001	2/3 = 5 Delikli Pano Top. Klemensi	42	21,39	50
1080102	ONKA - 2002	2/5 = 7 Delikli Pano Top. Klemensi	54	28,21	50
1080103	ONKA - 2003	2/8 = 10 Delikli Pano Top. Klemensi	73	38,49	50
1080104	ONKA - 2004	2/10 = 12 Delikli Pano Top. Klemensi	86	44,70	50
1080105	ONKA - 2005	2/13 = 15 Delikli Pano Top. Klemensi	105	54,67	50
1080106	ONKA - 2006	2/20 = 22 Delikli Pano Top. Klemensi	148	77,97	50
1080107	ONKA - 2007	2/40 = 42 Delikli Pano Top. Klemensi	285	147,00	50
1080108	ONKA - 2008	2/60 = 62 Delikli Pano Top. Klemensi	410	210,31	50
1080110	ONKA - 1999	1 metre, 159 Delikli Pano Top. Klemensi	1000	459,13	1

160 AMPER (A:12 x B:7 mm)

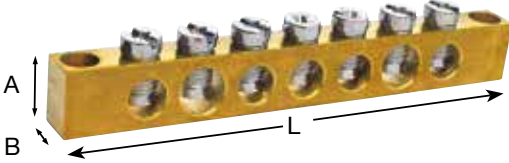

Kablo kesiti max. 25 mm²

YENİ KOD	ESKİ KOD	CİNSİ	L ± 2	ADET (t)	K. AD.
1080115	ONKA - 2021	2/5 = 7 Delikli Pano Top. Klemensi	69	39,24	50
1080116	ONKA - 2022	2/8 = 10 Delikli Pano Top. Klemensi	93	55,57	50
1080117	ONKA - 2023	2/10 = 12 Delikli Pano Top. Klemensi	119	66,48	50
1080118	ONKA - 2024	2/13 = 15 Delikli Pano Top. Klemensi	133	80,19	50
1080119	ONKA - 2025	2/20 = 22 Delikli Pano Top. Klemensi	188	115,65	50
1080121	ONKA - 2029	1 metre, 126 Delikli Pano Top. Klemensi	1000	590,12	1

250 AMPER (A:15 x B:10 mm)

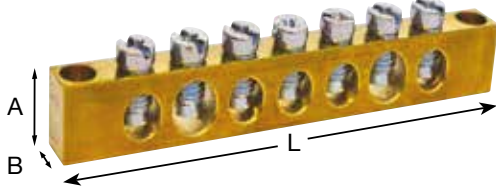

Kablo kesiti max. 50 mm²

YENİ KOD	ESKİ KOD	CİNSİ	L ± 2	ADET (t)	K. AD.
1080123	ONKA - 2041	2/5 = 7 Delikli Pano Top. Klemensi	69	112,01	50
1080124	ONKA - 2042	2/8 = 10 Delikli Pano Top. Klemensi	93	151,68	50
1080125	ONKA - 2043	2/10 = 12 Delikli Pano Top. Klemensi	119	185,36	50
1080126	ONKA - 2044	2/13 = 15 Delikli Pano Top. Klemensi	133	231,44	50
1080127	ONKA - 2045	2/20 = 22 Delikli Pano Top. Klemensi	188	338,97	50
1080128	ONKA - 2028	1 metre, 79 Delikli Pano Top. Klemensi	1000	1.026,42	1

1 KUTUPLU DAĞITICI ÜNİTELER

Raya montajlı kullanım için ray siparişi ayrıca verilmelidir.

80 AMPER (A:9 x B:6,5 mm)

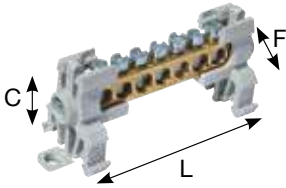

Çok Telli Kablo kesiti max. 10 mm²
Tek Damarlı Kablo kesiti max. 16 mm²

YENİ KOD	ESKİ KOD	CİNSİ	L ± 2	F ± 1	C ± 1	ADET (t)	K. AD.
1080001	ONKA - 2051	2 / 5 - 7 Delikli	71,4	24	28,2	34,53	32
1080002	ONKA - 2052	2 / 8 - 10 Delikli	89,9	24	28,2	44,48	24
1080003	ONKA - 2053	2 / 10 - 12 Delikli	102,4	24	28,2	51,42	18
1080004	ONKA - 2054	2 / 13 - 15 Delikli	120,9	24	28,2	61,73	16
1080005	ONKA - 2055	2 / 20 - 22 Delikli	164,9	24	28,2	85,81	12

160 AMPER (A:12 x B:7 mm)

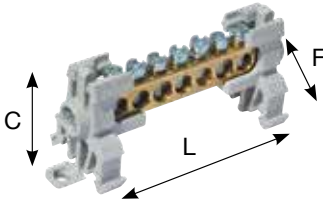

Kablo kesiti max. 25 mm²

YENİ KOD	ESKİ KOD	CİNSİ	L ± 2	F ± 1	C ± 1	ADET (t)	K. AD.
1080006	ONKA - 2056	2 / 5 - 7 Delikli	83	24	28,2	50,25	32
1080007	ONKA - 2057	2 / 8 - 10 Delikli	106,7	24	28,2	66,68	24
1080008	ONKA - 2058	2 / 10 - 12 Delikli	122,5	24	28,2	77,79	18
1080009	ONKA - 2059	2 / 13 - 15 Delikli	146,1	24	28,2	91,57	16
1080010	ONKA - 2060	2 / 20 - 22 Delikli	200,9	24	28,2	127,21	12

250 AMPER (A:15 x B:10 mm)

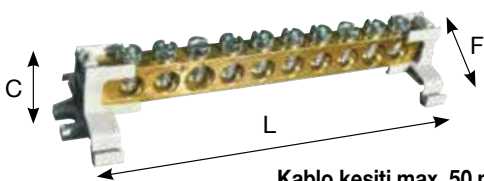

Kablo kesiti max. 50 mm²

YENİ KOD	ESKİ KOD	CİNSİ	L ± 2	F ± 1	C ± 1	ADET (t)	K. AD.
1080016	ONKA - 2066	2 / 5 - 7 Delikli	121	43,2	39	125,30	32
1080017	ONKA - 2067	2 / 8 - 10 Delikli	159	43,2	39	165,88	24
1080018	ONKA - 2068	2 / 10 - 12 Delikli	184	43,2	39	200,25	18
1080019	ONKA - 2069	2 / 13 - 15 Delikli	220,5	43,2	39	247,21	16
1080020	ONKA - 2070	2 / 20 - 22 Delikli	308	43,2	39	356,82	12

1 KUTUPLU DAĞITICI ÜNİTELER (KAPAKLI SİSTEM)

Raya montajlı kullanım için ray siparişi ayrıca verilmelidir.

80 AMPER (A:9 x B:6,5 mm)

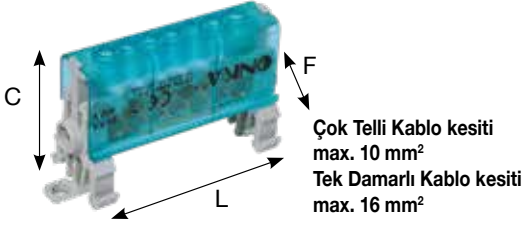

YENİ KOD	ESKİ KOD	CİNSİ	L ± 2	F ± 1	C ± 1	ADET (t)	K. AD.
1080011	ONKA - 2061	2 / 5 - 7 Delikli	71,4	24	37,5	37,88	32
1080012	ONKA - 2062	2 / 8 - 10 Delikli	89,9	24	37,5	48,41	24
1080013	ONKA - 2063	2 / 10 - 12 Delikli	102,4	24	37,5	55,82	18
1080014	ONKA - 2064	2 / 13 - 15 Delikli	120,9	24	37,5	67,48	16
1080015	ONKA - 2065	2 / 20 - 22 Delikli	164,9	24	28,2	93,05	12

160 AMPER (A:12 x B:7 mm)

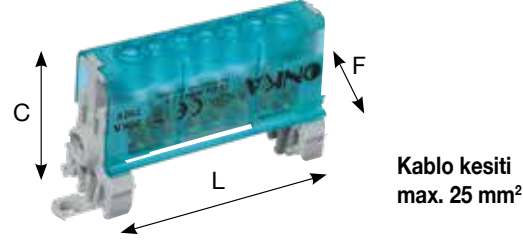

YENİ KOD	ESKİ KOD	CİNSİ	L ± 2	F ± 1	C ± 1	ADET (t)	K. AD.
1080021	ONKA - 2071	2 / 5 - 7 Delikli	83	24	37,5	54,59	32
1080022	ONKA - 2072	2 / 8 - 10 Delikli	106,7	24	37,5	71,85	24
1080023	ONKA - 2073	2 / 10 - 12 Delikli	122,5	24	37,5	83,44	18
1080024	ONKA - 2074	2 / 13 - 15 Delikli	146,1	24	37,5	98,56	16
1080025	ONKA - 2075	2 / 20 - 22 Delikli	200,9	24	37,5	135,86	12

250 AMPER (A:15 x B:10 mm)

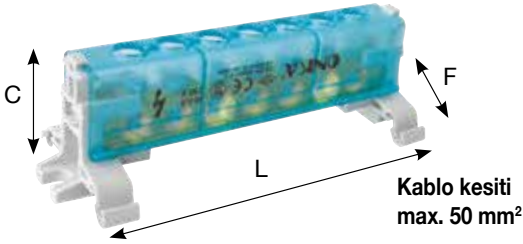

YENİ KOD	ESKİ KOD	CİNSİ	L ± 2	F ± 1	C ± 1	ADET (t)	K. AD.
1080026	ONKA - 2076	2 / 5 - 7 Delikli	121	43,2	38	134,22	32
1080027	ONKA - 2077	2 / 8 - 10 Delikli	159	43,2	38	175,66	24
1080028	ONKA - 2078	2 / 10 - 12 Delikli	184	43,2	38	210,30	18
1080029	ONKA - 2079	2 / 13 - 15 Delikli	220,5	43,2	38	258,73	16
1080030	ONKA - 2080	2 / 20 - 22 Delikli	308	43,2	38	368,94	12

2 KUTUPLU DAĞITICI ÜNİTELER (KAPAKLI SİSTEM)

Raya montajlı kullanım için ray siparişi ayrıca verilmelidir.

80 AMPER (A:9 x B:6,5 mm)

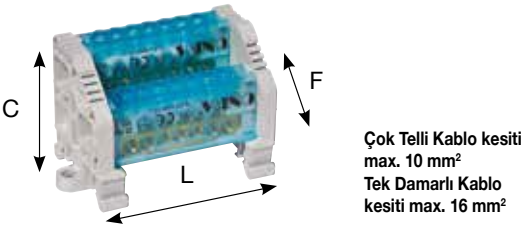

YENİ KOD	ESKİ KOD	CİNSİ	L ± 2	F ± 1	C ± 1	ADET (t)	K. AD.
1080031	ONKA - 2081	2 / 5 - 7 Delikli	82,7	50,8	46,6	87,15	1
1080032	ONKA - 2082	2 / 8 - 10 Delikli	101,7	50,8	46,6	108,39	1
1080033	ONKA - 2083	2 / 10 - 12 Delikli	114,2	50,8	46,6	123,21	1
1080034	ONKA - 2084	2 / 13 - 15 Delikli	132,7	50,8	46,6	148,56	1
1080035	ONKA - 2085	2 / 20 - 22 Delikli	176,5	50,8	46,6	200,20	1

160 AMPER (A:12 x B:7 mm)

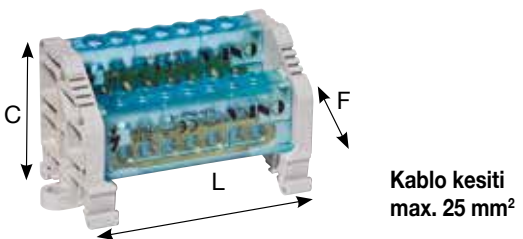

YENİ KOD	ESKİ KOD	CİNSİ	L ± 2	F ± 1	C ± 1	ADET (t)	K. AD.
1080041	ONKA - 2091	2 / 5 - 7 Delikli	95,2	50,8	46,6	111,22	1
1080042	ONKA - 2092	2 / 8 - 10 Delikli	118,7	50,8	46,6	146,00	1
1080043	ONKA - 2093	2 / 10 - 12 Delikli	134,2	50,8	46,6	169,25	1
1080044	ONKA - 2094	2 / 13 - 15 Delikli	157,2	50,8	46,6	201,62	1
1080045	ONKA - 2095	2 / 20 - 22 Delikli	212,2	50,8	46,6	276,19	1

250 AMPER (A:15 x B:10 mm)

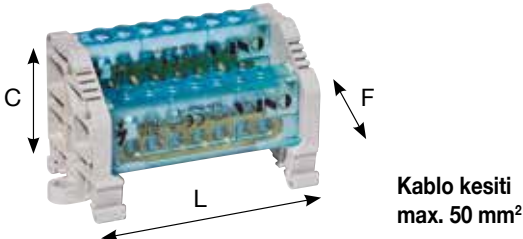

YENİ KOD	ESKİ KOD	CİNSİ	L ± 2	F ± 1	C ± 1	ADET (t)	K. AD.
1080036	ONKA - 2086	2 / 5 - 7 Delikli	135	55	50	290,68	1
1080037	ONKA - 2087	2 / 8 - 10 Delikli	172,5	55	50	374,37	1
1080038	ONKA - 2088	2 / 10 - 12 Delikli	197	55	50	442,78	1
1080039	ONKA - 2089	2 / 13 - 15 Delikli	235	55	50	538,67	1
1080040	ONKA - 2090	2 / 20 - 22 Delikli	322,5	55	50	762,25	1

3 KUTUPLU DAĞITICI ÜNİTELER (KAPAKLI SİSTEM)

Raya montajlı kullanım için ray siparişi ayrıca verilmelidir.

80 AMPER (A:9 x B:6,5 mm)

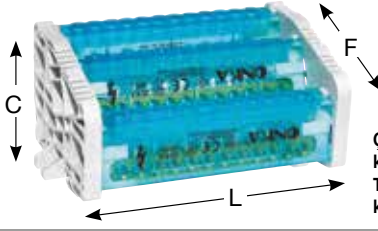

Çok Telli Kablo kesiti max. 10 mm²
Tek Damarlı Kablo kesiti max. 16 mm²

YENİ KOD	ESKİ KOD	CİNSİ	L ± 2	F ± 1	C ± 1	ADET (t)	K. AD.
1080066	ONKA - 2171	2 / 5 - 7 Delikli	82,7	66	47	127,31	1
1080067	ONKA - 2172	2 / 8 - 10 Delikli	101,6	66	47	159,05	1
1080068	ONKA - 2173	2 / 10 - 12 Delikli	113,9	66	47	181,04	1
1080069	ONKA - 2174	2 / 13 - 15 Delikli	132,8	66	47	219,27	1
1080070	ONKA - 2175	2 / 20 - 22 Delikli	176,5	66	47	296,12	1

160 AMPER (A:12 x B:7 mm)

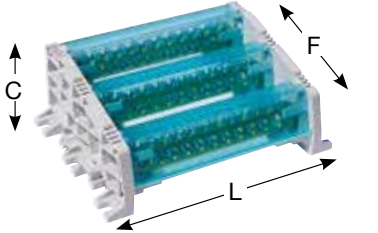

Kablo kesiti max. 25 mm²

YENİ KOD	ESKİ KOD	CİNSİ	L ± 2	F ± 1	C ± 1	ADET (t)	K. AD.
1080061	ONKA - 2151	2 / 5 - 7 Delikli	95	66	47	173,14	1
1080062	ONKA - 2152	2 / 8 - 10 Delikli	118,5	66	47	225,08	1
1080063	ONKA - 2153	2 / 10 - 12 Delikli	134	66	47	259,95	1
1080064	ONKA - 2154	2 / 13 - 15 Delikli	157	66	47	307,36	1
1080065	ONKA - 2155	2 / 20 - 22 Delikli	212	66	47	419,70	1

250 AMPER (A:15 x B:10 mm)

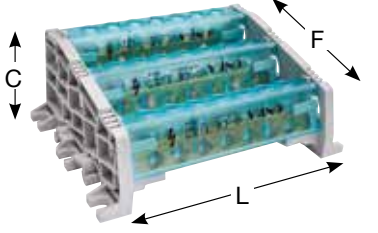

Kablo kesiti max. 50 mm²

YENİ KOD	ESKİ KOD	CİNSİ	L ± 2	F ± 1	C ± 1	ADET (t)	K. AD.
1080071	ONKA - 2181	2 / 5 - 7 Delikli	117	94,5	50	424,52	1
1080072	ONKA - 2182	2 / 8 - 10 Delikli	154,5	94,5	50	549,65	1
1080073	ONKA - 2183	2 / 10 - 12 Delikli	179	94,5	50	654,08	1
1080074	ONKA - 2184	2 / 13 - 15 Delikli	217	94,5	50	796,63	1
1080075	ONKA - 2185	2 / 20 - 22 Delikli	304,5	94,5	50	1.132,22	1

250 AMPER (A:15 x B:10 mm) Yüksek Model

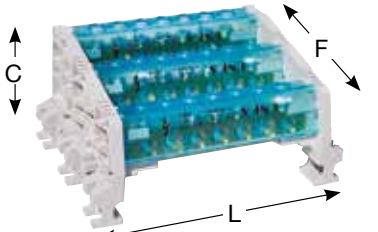

Kablo kesiti max. 50 mm²

YENİ KOD	ESKİ KOD	CİNSİ	L ± 2	F ± 1	C ± 1	ADET (t)	K. AD.
1080076	ONKA - 2186	2 / 5 - 7 Delikli	135	95	65	434,79	1
1080077	ONKA - 2187	2 / 8 - 10 Delikli	172,5	95	65	559,92	1
1080078	ONKA - 2188	2 / 10 - 12 Delikli	197	95	65	664,36	1
1080079	ONKA - 2189	2 / 13 - 15 Delikli	235	95	65	806,96	1
1080080	ONKA - 2190	2 / 20 - 22 Delikli	322,5	95	65	1.142,48	1

4 KUTUPLU DAĞITICI ÜNİTELER (KAPAKLI SİSTEM)

Raya montajlı kullanım için ray siparişi ayrıca verilmelidir.

80 AMPER (A:9 x B:6,5 mm)

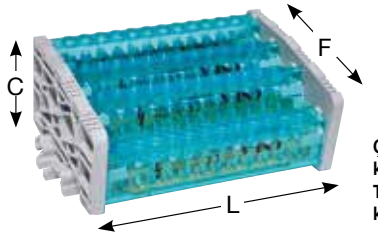

Çok Telli Kablo kesiti max. 10 mm²
Tek Damarlı Kablo kesiti max. 16 mm²

YENİ KOD	ESKİ KOD	CİNSİ	L ± 2	F ± 1	C ± 1	ADET (t)	K. AD.
1080086	ONKA - 2201	2 / 5 - 7 Delikli	85,8	86	48,5	158,97	1
1080087	ONKA - 2202	2 / 8 - 10 Delikli	104,7	86	48,5	201,03	1
1080088	ONKA - 2203	2 / 10 - 12 Delikli	117	86	48,5	230,36	1
1080089	ONKA - 2204	2 / 13 - 15 Delikli	135,9	86	48,5	277,70	1
1080090	ONKA - 2205	2 / 20 - 22 Delikli	179,6	86	48,5	381,25	1

160 AMPER (A:12 x B:7 mm)

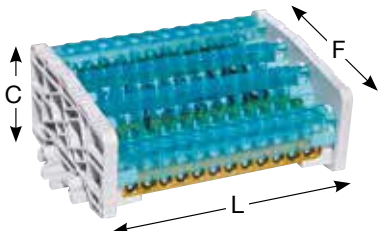

Kablo kesiti max. 25 mm²

YENİ KOD	ESKİ KOD	CİNSİ	L ± 2	F ± 1	C ± 1	ADET (t)	K. AD.
1080091	ONKA - 2211	2 / 5 - 7 Delikli	97,7	86	48,5	216,38	1
1080092	ONKA - 2212	2 / 8 - 10 Delikli	121,2	86	48,5	285,52	1
1080093	ONKA - 2213	2 / 10 - 12 Delikli	136,7	86	48,5	331,67	1
1080094	ONKA - 2214	2 / 13 - 15 Delikli	159,7	86	48,5	393,56	1
1080095	ONKA - 2215	2 / 20 - 22 Delikli	214,7	86	48,5	543,08	1

4 KUTUPLU DAĞITICI ÜNİTELER (KAPAKLI SİSTEM)

Raya montajlı kullanım için ray siparişi ayrıca verilmelidir.

250 AMPER (A:15 x B:10 mm)

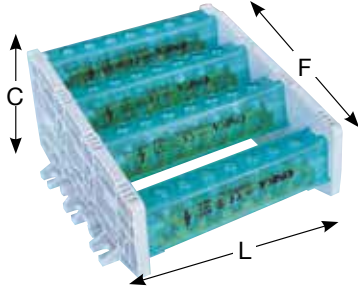

Kablo kesiti
max. 50 mm²

YENİ KOD	ESKİ KOD	CİNSİ	L ± 2	F ± 1	C ± 1	ADET (t)	K. AD.
1080056	ONKA - 2116	2 / 5 - 7 Delikli	135,5	130	68	562,60	1
1080057	ONKA - 2117	2 / 8 - 10 Delikli	172,6	130	68	729,18	1
1080058	ONKA - 2118	2 / 10 - 12 Delikli	197	130	68	865,48	1
1080059	ONKA - 2119	2 / 13 - 15 Delikli	235	130	68	1.054,68	1
1080060	ONKA - 2120	2 / 20 - 22 Delikli	322,5	130	68	1.500,52	1

80 AMPER (A:9 x B:6,5 mm)

Yüksek Model

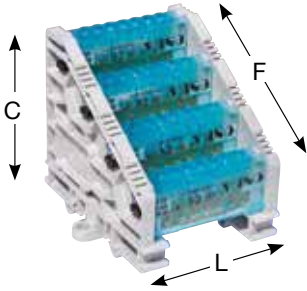

Çok Telli Kablo
kesiti max. 10 mm²
Tek Damarlı Kablo
kesiti max. 16 mm²

YENİ KOD	ESKİ KOD	CİNSİ	L ± 2	F ± 1	C ± 1	ADET (t)	K. AD.
1080046	ONKA - 2101	2 / 5 - 7 Delikli	84,3	86,5	82,3	172,85	1
1080047	ONKA - 2102	2 / 8 - 10 Delikli	103,2	86,5	82,3	214,98	1
1080048	ONKA - 2103	2 / 10 - 12 Delikli	115,5	86,5	82,3	244,31	1
1080049	ONKA - 2104	2 / 13 - 15 Delikli	134,4	86,5	82,3	292,80	1
1080050	ONKA - 2105	2 / 20 - 22 Delikli	178,1	86,5	82,3	395,25	1

160 AMPER (A:12 x B:7 mm)

Yüksek Model

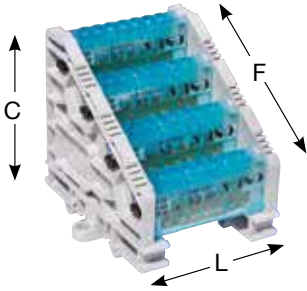

Kablo kesiti
max. 25 mm²

YENİ KOD	ESKİ KOD	CİNSİ	L ± 2	F ± 1	C ± 1	ADET (t)	K. AD.
1080051	ONKA - 2111	2 / 5 - 7 Delikli	95,5	86,5	82,3	223,15	1
1080052	ONKA - 2112	2 / 8 - 10 Delikli	119,5	86,5	82,3	292,27	1
1080053	ONKA - 2113	2 / 10 - 12 Delikli	135	86,5	82,3	338,98	1
1080054	ONKA - 2114	2 / 13 - 15 Delikli	158	86,5	82,3	399,70	1
1080055	ONKA - 2115	2 / 20 - 22 Delikli	213	86,5	82,3	551,56	1

5 KUTUPLU DAĞITICI ÜNİTELER (KAPAKLI SİSTEM)

Raya montajlı kullanım için ray siparişi ayrıca verilmelidir.

250 AMPER (A:15 x B:10 mm)

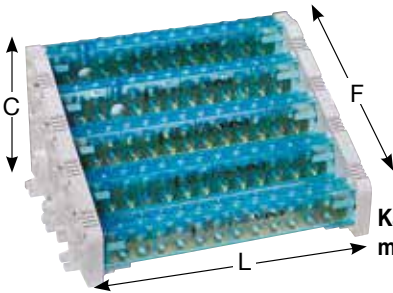

Kablo kesiti
max. 50 mm²

YENİ KOD	ESKİ KOD	CİNSİ	L ± 2	F ± 1	C ± 1	ADET (t)	K. AD.
1080081	ONKA - 2191	2 / 5 - 7 Delikli	143	150	96	686,65	1
1080082	ONKA - 2192	2 / 8 - 10 Delikli	180,5	150	96	894,67	1
1080083	ONKA - 2193	2 / 10 - 12 Delikli	205	150	96	1.069,56	1
1080084	ONKA - 2194	2 / 13 - 15 Delikli	243	150	96	1.305,25	1
1080085	ONKA - 2195	2 / 20 - 22 Delikli	329	150	96	1.859,79	1

250 AMPER (A:15 x B:10 mm)

Yüksek Model

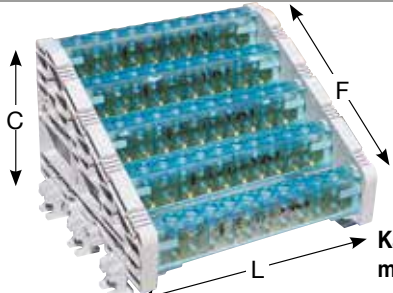

Kablo kesiti
max. 50 mm²

YENİ KOD	ESKİ KOD	CİNSİ	L ± 2	F ± 1	C ± 1	ADET (t)	K. AD.
1080096	ONKA - 2216	2 / 5 - 7 Delikli	143	150	111	695,17	1
1080097	ONKA - 2217	2 / 8 - 10 Delikli	180,5	150	111	903,19	1
1080098	ONKA - 2218	2 / 10 - 12 Delikli	205	150	111	1.076,91	1
1080099	ONKA - 2219	2 / 13 - 15 Delikli	243	150	111	1.312,70	1
1080100	ONKA - 2220	2 / 20 - 22 Delikli	329	150	111	1.868,87	1

DAĞITICI ÜNİTE YÜKSELTİCİ AYAKLARI



YENİ KOD	ESKİ KOD	CİNSİ	ADET (t)	KUTU ADEDİ
1080135	ONKA-2134	1 - 3 - 5'li dağıtıcı üniteler için yükseltme ayakları	1,92	100

5 KADEMELİ 30 x 5 mm BAKIR BARA DAĞITICI ÜNİTELER VE AKSESUARİ



YENİ KOD	ESKİ KOD	CİNSİ	ADET (t)	KUTU ADEDİ
1080134	ONKA-2131	5 Katlı Dağıtıcı Ünite (Max. 30x5) Yatak	87,77	10

FORMLAMA İZOLATÖRÜ

(3/4 Kutuplu - Max. 40x10 mm Bara ile kullanılır.)



UL 94 V0 Yanmazlık seviyesi , ergonomik ve kompakt yapı, yüksek kısadevre güçlerine karşı geliştirilmiş tasarımıyla kısa devre dinamikleri ve kamçılanmalara karşı maximum emniyetle güvenli ve estetik bara dizaynı sağlayarak Form1-2-3-4 seçeneklerinde kolay montaj ve işletme çözümü sunar.



- 20 x 5 / 10
- 25 x 5 / 10
- 30 x 5 / 10
- 40 x 5 / 10

Baralar ile esnek dağıtım çözümleri

ÜRÜN KODU	CİNSİ	TAKIM (t)
İRTPF-4003	3 Kutuplu Formlama İzolatörü (Max. 40x10)	360,00
İRTPF-4004	4 Kutuplu Formlama İzolatörü (Max. 40x10)	500,00

* Sağ + Sol ünite kombinasyonu min. 1 takım olarak sevk edilir.

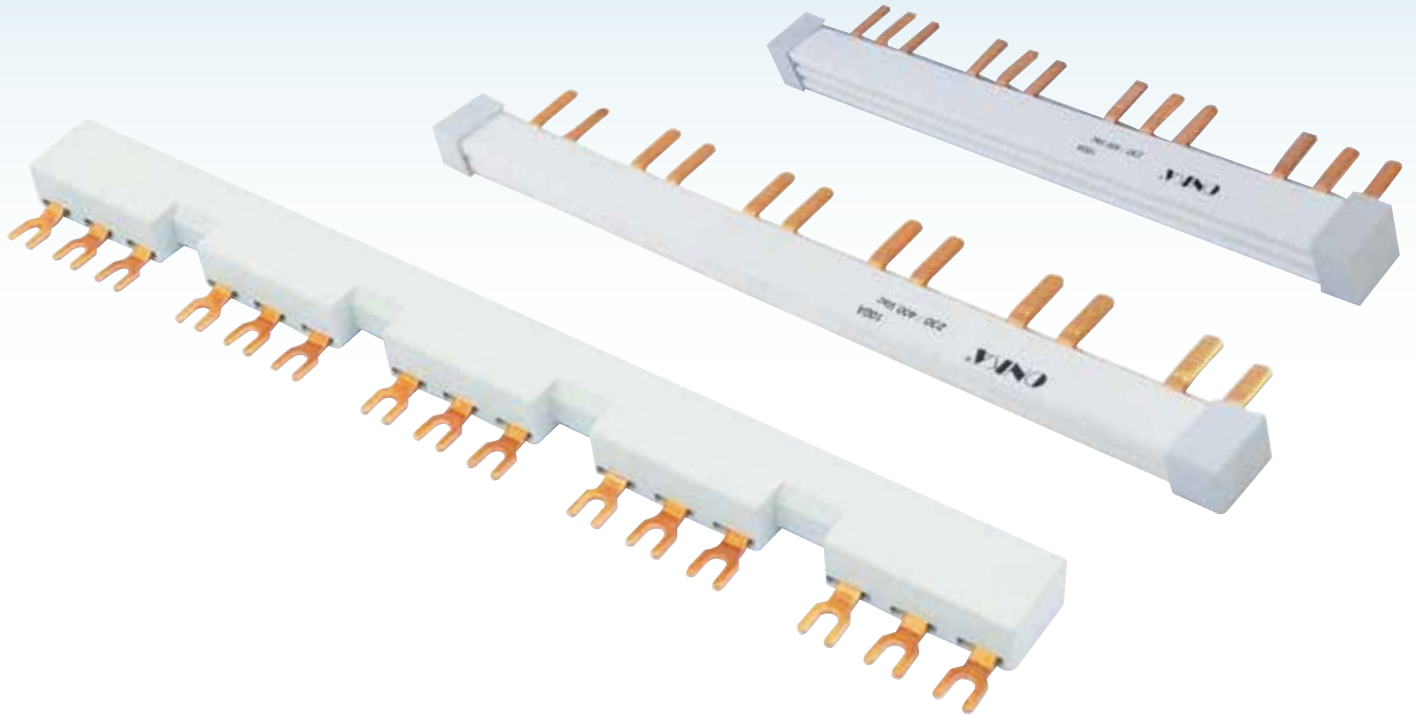

W OTOMAT BARALARI

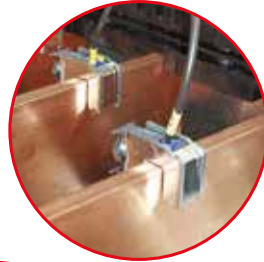

MONOFAZE MÜŞTEREK W OTOMAT BARALARI (İĞNE TİP)

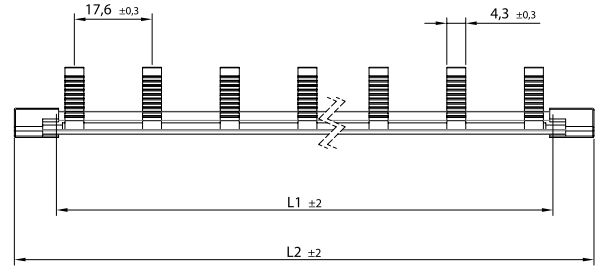

Kod: 3000

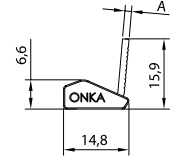

1mm / 80A		1,5mm / 100A		2mm / 125A		MODÜL ADEDİ	KUTU ADEDİ
ÜRÜN KODU	ADET (t)	ÜRÜN KODU	ADET (t)	ÜRÜN KODU	ADET (t)		
ONKA-3006	Ⓢ	ONKA-3001	Ⓢ	ONKA-3011	Ⓢ	12	50
ONKA-3007		ONKA-3002		ONKA-3012		18	50
ONKA-3008		ONKA-3003		ONKA-3013		24	50
ONKA-3009		ONKA-3004		ONKA-3014		30	50
ONKA-3010		ONKA-3005		ONKA-3015		56	50
ONKA-3000	Monofaze Bara Yan Kapak				Ⓢ	-	100

2 FAZLI MÜŞTEREK W OTOMAT BARALARI (İĞNE TİP)

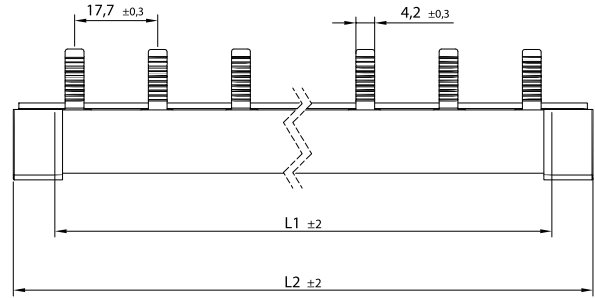

Kod: 3026

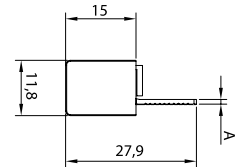

1mm / 80A		1,5mm / 100A		CİNSİ	MODÜL ADEDİ	KUTU ADEDİ
ÜRÜN KODU	ADET (t)	ÜRÜN KODU	ADET (t)			
ONKA-3021	Ⓢ	ONKA-3031	Ⓢ	İğne Tip	6	30
ONKA-3022		ONKA-3032		İğne Tip	9	30
ONKA-3023		ONKA-3033		İğne Tip	12	30
ONKA-3024		ONKA-3034		İğne Tip	15	30
ONKA-3025		ONKA-3035		İğne Tip	28	30
ONKA-3026	İki Fazlı Müşterek W Otomat Barası Yan Kapak				-	100

TRİFAZE MÜŞTEREK W OTOMAT BARALARI (İĞNE TİP)

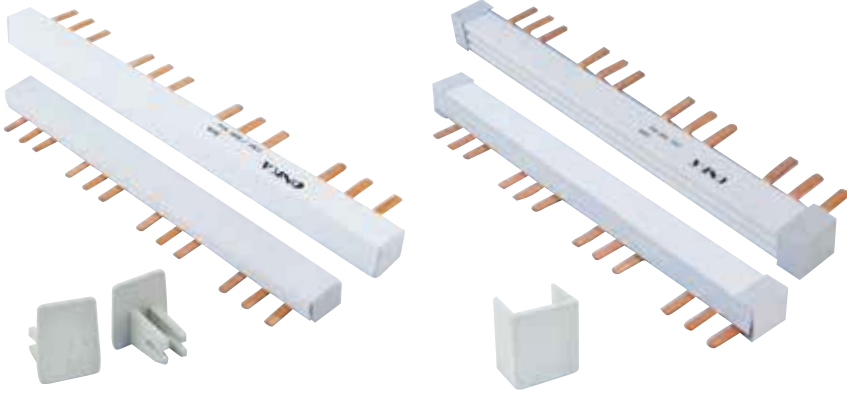

Kod: 5833

Kod: 3056

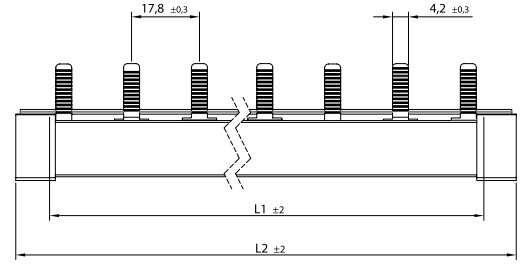

- 1,0 mm
- 1,5 mm
- 2,0 mm

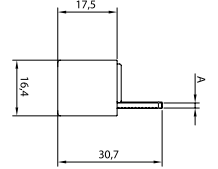

1mm / 80A		1,5mm / 100A		2mm / 125A		MODÜL ADEDİ	KUTU ADEDİ
ÜRÜN KODU	ADET (t)	ÜRÜN KODU	ADET (t)	ÜRÜN KODU	ADET (t)		
ONKA-3041	Ⓢ	ONKA-3051	Ⓢ	ONKA-3066	Ⓢ	4	30
ONKA-3042		ONKA-3052		ONKA-3067		6	30
ONKA-3043		ONKA-3053		ONKA-3068		8	30
ONKA-3044		ONKA-3054		ONKA-3069		10	30
ONKA-3045		ONKA-3055		ONKA-3070		20	25
ONKA-3056	Trifaze Bara Yan Kapak				Ⓢ	-	100
ONKA-5833	1 mm Trifaze Bara Yan Kapak					-	100

3 FAZ + NÖTR MÜŞTEREK W OTOMAT BARALARI (İĞNE TİP)

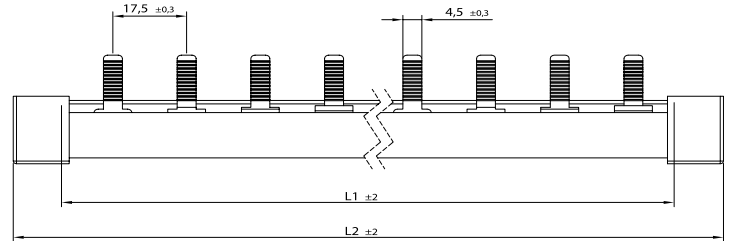
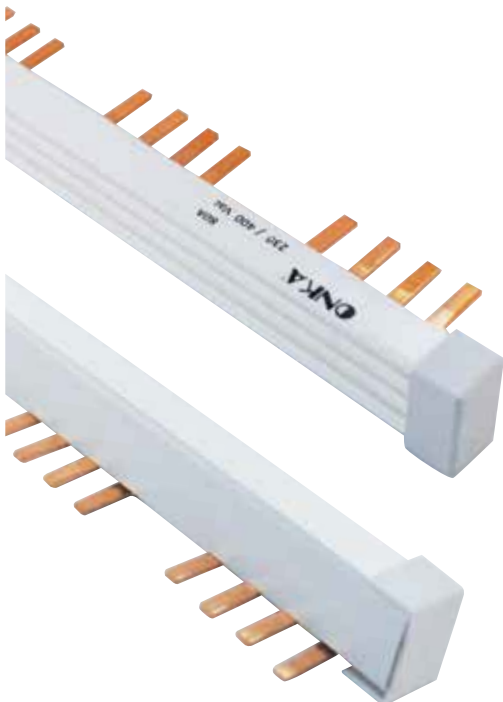

Kod: 3057

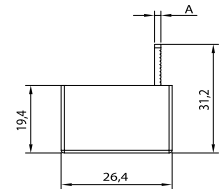

1,5 mm / 100A		MODÜL ADEDİ	KUTU ADEDİ
ÜRÜN KODU	ADET (t)		
ONKA-3058	Ⓢ	4	16
ONKA-3059		8	16
ONKA-3060		14	16
ONKA-3057	4 Kutuplu Bara Yan Kapak		100

İZOLASYONLU MOTOR KORUMA BARALARI (63 A)



ÜRÜN KODU	CİNSİ	ADET (€)	KUTU ADEDİ
ONKA-MSVG54-14-2	Motor Koruma Barası, İkili Modül, Adım Genişliği 45 + 9 = 54 mm	10,52 €	1
ONKA-MSVG54-14-4	Motor Koruma Barası, Dörtlü Modül, Adım Genişliği 45 + 9 = 54 mm	15,58 €	1
ONKA-MSVG54-14-5	Motor Koruma Barası, Beşli Modül, Adım Genişliği 45 + 9 = 54 mm	18,08 €	1
ONKA-MSG45-14-3	Motor Koruma Barası, Üçlü Modül, Boşluk Yok, Adım Genişliği 45 mm	12,80 €	1
ONKA-MSG45-14-4	Motor Koruma Barası, Dörtlü Modül, Boşluk Yok, Adım Gen. 45 mm	14,96 €	1

(L1+N, L2+N, L3+N) MÜŞTEREK W OTOMAT BARA, İĞNE TİP (80 A)

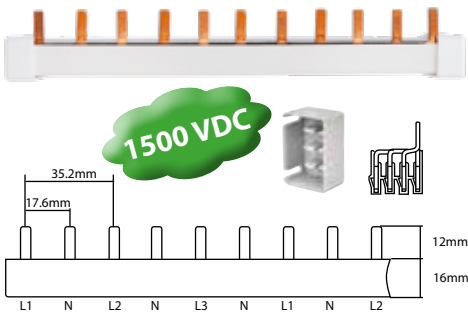

ÜRÜN KODU	CİNSİ	ADET (€)	KUTU ADEDİ
FTG-4S16L54A0A0N-01	L1 + N, L2 + N, L3 + N ... 13 MODÜL 1 mt	94,80 €	1
FTG-A2	Müşterek W Otomat Barası Yan Kapak	0,60 €	1

MODÜLER GÜÇ KLEMENSLERİ (Monofaze-Difaze-Trifaze Bağlantı Klemensi)

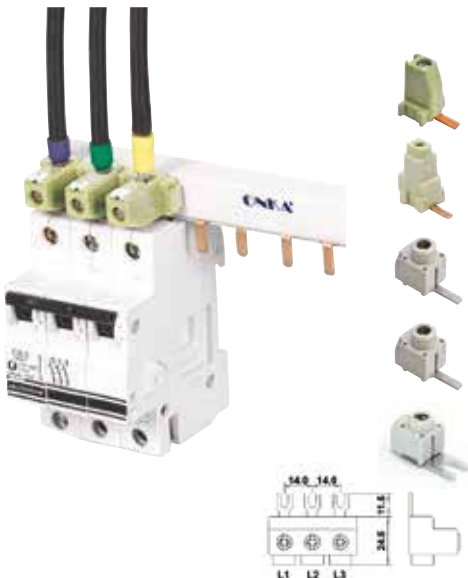

YENİ KOD	ESKİ KOD	CİNSİ	ADET	KUTU ADEDİ
1140013	ONKA-3061	No.1 (2.5 - 10 mm ²)	11,80 ₺	150
1140014	ONKA-3065	No.2 (16 - 25 mm ²)	20,37 ₺	100
FTG-802/115 S		No.2 (6 - 25 mm ²)	2,20 €	30
FTG-802/215 S		No.3 (6 - 50 mm ²)	2,90 €	25
FTG-802/114		No.2 (6 - 25 mm ²) Çatal Uçlu	2,20 €	25
FTG-MSV GE 1-14		No.2 (6 - 25 mm ²) Çatal Uçlu, Üçlü (L1,L2,L3)	10,64 €	1



BAKIR BARA BAĞLANTI KLEMENSİ (YAY BASKILI) 16 mm²

YENİ KOD	ESKİ KOD	CİNSİ	GERİLİM / AKIM (V/A)	ADET (t)	KUTU ADEDİ
1140007	ONKA-2140	SK16 F5 Bakır Bara Klemensi 1,5 - 16 mm ²	690 V / 180 A	23,38 t	100
1140008	ONKA-2141	SK16 F10 Bakır Bara Klemensi 1,5 - 16 mm ²	690 V / 180 A	23,90 t	100

BAKIR BARA BAĞLANTI KLEMENSİ (YAY BASKILI) 35 mm²

YENİ KOD	ESKİ KOD	CİNSİ	GERİLİM / AKIM (V/A)	ADET (t)	KUTU ADEDİ
1140009	ONKA-2142	SK35 F5 Bakır Bara Klemensi 1,5 - 35 mm ²	690 V / 270 A	37,51 t	50
1140010	ONKA-2143	SK35 F10 Bakır Bara Klemensi 1,5 - 35 mm ²	690 V / 270 A	39,12 t	50

BAKIR BARA BAĞLANTI KLEMENSİ (YAY BASKILI) 70 mm²

ÜRÜN KODU	CİNSİ	GERİLİM / AKIM (V/A)	ADET (t)	KUTU ADEDİ
ONKA-2144	SK70 F5 Bakır Bara Klemensi, 16 - 70 mm ²	690 V / 400 A	88,75 t	10
ONKA-2145	SK70 F10 Bakır Bara Klemensi, 16 - 70 mm ²	690 V / 400 A	104,25 t	10

BAKIR BARA BAĞLANTI KLEMENSİ (YAY BASKILI) 120 mm²

ÜRÜN KODU	CİNSİ	GERİLİM / AKIM (V/A)	ADET (t)	KUTU ADEDİ
ONKA-2146	SK120 F5 Bakır Bara Klemensi, 16 - 120 mm ²	690 V / 440 A	149,00 t	10
ONKA-2147	SK120 F10 Bakır Bara Klemensi, 16 - 120 mm ²	690 V / 440 A	158,75 t	10

5 mm Bara için

2140



2144



2142



2146



10 mm Bara için

2141



2145



2143



2147



GEÇMELİ BAKIR BARA BAĞLANTI KLEMENSLERİ (PALETLİ SİSTEM)

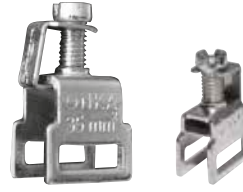
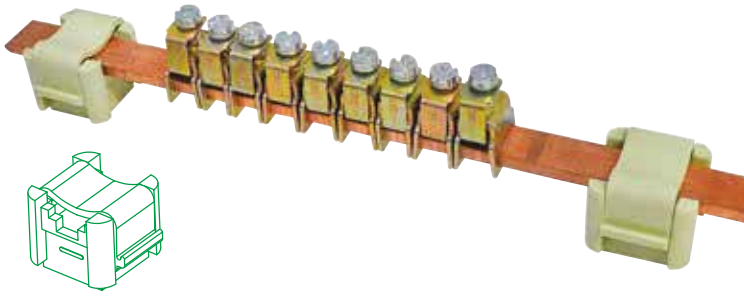

Bağlantı Kesiti 4 mm²

YENİ KOD	ESKİ KOD	CİNSİ	GERİLİM / AKIM (V/A)	ADET (t)	KUTU ADEDİ
ONKA-2159		12 x 3 mm Bakır Bara için Klemens 4 mm ² kablo kesiti	690 V / 400 A	6,95 t	300
1140011	ONKA-2160	12 x 3 mm Bakır Bara için Klemens 16 mm ² kablo kesiti	690 V / 400 A	8,40 t	300
1140012	ONKA-2161	12 x 3 mm Bakır Bara için Klemens 35 mm ² kablo kesiti	690 V / 440 A	9,94 t	250
ONKA-2162		12 x 3 mm Elektrolitik Bakır Bara 1 mt.		⚡	1 mt.

(NÖTR) VİDALI TOPRAKLAMA BARALARI



CİNSİ	1,5 x 15 mm			2 x 15 mm			3 x 15 mm			KUTU ADEDİ
	YENİ KOD	ESKİ KOD	ADET (t)	YENİ KOD	ESKİ KOD	ADET (t)	YENİ KOD	ESKİ KOD	ADET (t)	
31 Vida	1140001	ONKA-3075	373,00 t	1140003	ONKA-3080	480,20 t	1140005	ONKA-3088	650,25 t	25
62 Vida	1140002	ONKA-3076	435,00 t	1140004	ONKA-3087	532,00 t	1140006	ONKA-3086	712,20 t	25

(NÖTR/TOPRAK) BARA MESNEDİ

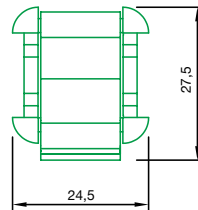
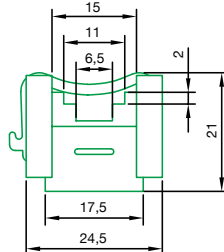

YENİ KOD	ESKİ KOD	CİNSİ	ADET (t)	KUTU ADEDİ
1140015	ONKA-3091	Bara Mesnedi	6,65 t	100



MONTAJ RAYLARI

DIN 46277-3 / TS EN 60715
Standartlarına Uygundur.



0 FİRE

+

0 KOROZYON

+

0 İŞÇİLİK

=

MALİYET AVANTAJI

İSTENİLEN
ÖLÇÜDE KESİM
FİREDEN TASARRUF

KESİMDEN SONRA
KAPLAMA
DAHA YÜKSEK KALİTE

ZAMANDAN
TASARRUF

cm Fiyatı



MONTAJ RAYLARI

35 x 7,5 DÜZ GALVANİZ KAPLAMALI



GR 333 gr/mt.

YENİ KOD	ESKİ KOD	CİNSİ	ADET (t)	KUTU ADEDİ
1100083	ONKA - 4211	30 cm	12,57	100
1100084	ONKA - 4212	1 m	34,57	50
1100085	ONKA - 4213	2 m	68,76	50

35 x 7,5 DELİKLİ GALVANİZ KAPLAMALI

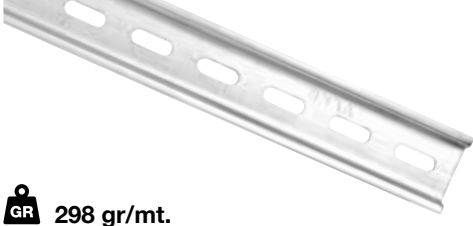

GR 298 gr/mt.

YENİ KOD	ESKİ KOD	CİNSİ	ADET (t)	KUTU ADEDİ
1100090	ONKA - 4221	30 cm	12,57	100
1100091	ONKA - 4222	1 m	33,75	50
1100092	ONKA - 4223	2 m	67,19	50

35 x 7,5 DÜZ CR+3 KAPLAMALI



GR 333 gr/mt.

YENİ KOD	ESKİ KOD	CİNSİ	ADET (t)	KUTU ADEDİ
1100011	ONKA - 4021	30 cm	15,24	100
1100012	ONKA - 4022	1 m	42,54	50
1100013	ONKA - 4023	2 m	86,66	50

35 x 7,5 DELİKLİ CR+3 KAPLAMALI



GR 298 gr/mt.

YENİ KOD	ESKİ KOD	CİNSİ	ADET (t)	KUTU ADEDİ
1100016	ONKA - 4031	30 cm	15,24	100
1100017	ONKA - 4032	1 m	41,72	50
1100018	ONKA - 4033	2 m	85,09	50

35 x 7,5 DÜZ ALÜMİNYUM



YENİ KOD	ESKİ KOD	CİNSİ	ADET (t)	KUTU ADEDİ
1100065	ONKA - 4121	30 cm	34,75	100
1100066	ONKA - 4122	1 m	110,25	35
1100067	ONKA - 4123	2 m	222,62	35

35 x 7,5 DELİKLİ ALÜMİNYUM



YENİ KOD	ESKİ KOD	CİNSİ	ADET (t)	KUTU ADEDİ
1100070	ONKA - 4131	30 cm	35,67	100
1100071	ONKA - 4132	1 m	113,00	35
1100072	ONKA - 4133	2 m	227,57	35

MONTAJ RAYLARI

35 x 15 DÜZ GALVANİZ KAPLAMALI



GR 665 gr/mt.

YENİ KOD	ESKİ KOD	CİNSİ	ADET (t)	KUTU ADEDİ
1100099	ONKA - 4231	30 cm	23,14	100
1100100	ONKA - 4232	1 m	71,00	25
1100101	ONKA - 4233	2 m	142,45	25

35 x 15 DELİKLİ GALVANİZ KAPLAMALI



GR 595 gr/mt.

YENİ KOD	ESKİ KOD	CİNSİ	ADET (t)	KUTU ADEDİ
1100104	ONKA - 4241	30 cm	22,80	100
1100105	ONKA - 4242	1 m	70,32	25
1100106	ONKA - 4243	2 m	141,10	25

35 x 15 DÜZ CR+3 KAPLAMALI



GR 665 gr/mt.

YENİ KOD	ESKİ KOD	CİNSİ	ADET (t)	KUTU ADEDİ
1100034	ONKA - 4061	30 cm	26,78	100
1100035	ONKA - 4062	1 m	87,09	25
1100036	ONKA - 4063	2 m	175,36	25

35 x 15 DELİKLİ CR+3 KAPLAMALI



GR 595 gr/mt.

YENİ KOD	ESKİ KOD	CİNSİ	ADET (t)	KUTU ADEDİ
1100039	ONKA - 4071	30 cm	26,78	100
1100044	ONKA - 4072	1 m	87,09	25
1100041	ONKA - 4073	2 m	175,36	25

MG TİPİ DÜZ ALÜMİNYUM

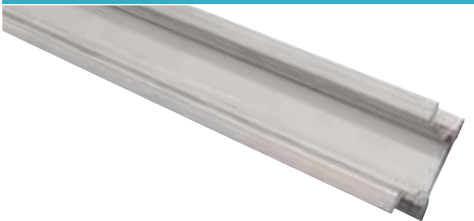

YENİ KOD	ESKİ KOD	CİNSİ	ADET (t)	KUTU ADEDİ
1100075	ONKA - 4141	30 cm	52,74	25
1100076	ONKA - 4142	1 m	172,37	25
1100077	ONKA - 4143	2 m	342,57	25

MG TİPİ DELİKLİ ALÜMİNYUM



YENİ KOD	ESKİ KOD	CİNSİ	ADET (t)	KUTU ADEDİ
1100079	ONKA - 4146	30 cm	53,66	25
1100080	ONKA - 4147	1 m	175,12	25
1100081	ONKA - 4148	2 m	347,52	25

MONTAJ RAYLARI

15 x 5,5 DÜZ GALVANİZ KAPLAMALI



YENİ KOD	ESKİ KOD	CİNSİ	ADET (t)	KUTU ADEDİ
1100109	ONKA - 4246	30 cm	7,41	100
1100110	ONKA - 4247	1 m	20,92	100
1100111	ONKA - 4248	2 m	38,53	50

15 x 5,5 DELİKLİ GALVANİZ KAPLAMALI

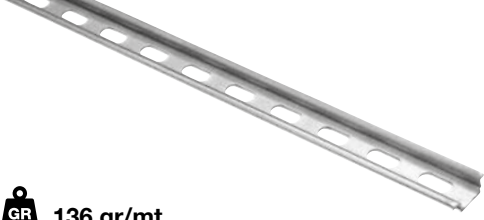

GR 136 gr/mt.

YENİ KOD	ESKİ KOD	CİNSİ	ADET (t)	KUTU ADEDİ
1100114	ONKA - 4251	30 cm	7,19	100
1100115	ONKA - 4252	1 m	20,47	100
1100116	ONKA - 4253	2 m	38,53	50

15 x 5,5 DÜZ CR+3 KAPLAMALI



YENİ KOD	ESKİ KOD	CİNSİ	ADET (t)	KUTU ADEDİ
1100054	ONKA - 4101	30 cm	8,16	100
1100055	ONKA - 4102	1 m	24,55	100
1100056	ONKA - 4103	2 m	45,79	50

15 x 5,5 DELİKLİ CR+3 KAPLAMALI

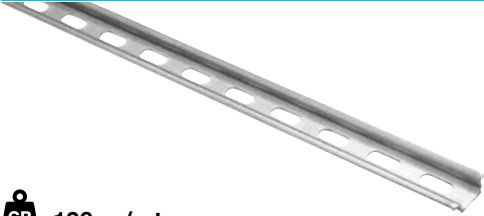

GR 136 gr/mt.

YENİ KOD	ESKİ KOD	CİNSİ	ADET (t)	KUTU ADEDİ
1100059	ONKA - 4111	30 cm	8,16	100
1100060	ONKA - 4112	1 m	24,55	100
1100061	ONKA - 4113	2 m	45,79	50

U PROFİL DESTEK RAYI (CR+3)



YENİ KOD	ESKİ KOD	CİNSİ	ADET (t)	KUTU ADEDİ
1100120	ONKA-4191	1 Metre U Profil (Cr3)	116,48	35
1100121	ONKA-4192	2 Metre U Profil (Cr3)	218,76	35
1100122	ONKA-4193	3 Metre U Profil (Cr3)	306,71	25
1100124	ONKA-4195	Sağ/Sol Köşe Aparatı	7,19	100

RAY TAŞIYICI

SAC CR + 3



YENİ KOD	ESKİ KOD	CİNSİ	ADET (t)	KUTU ADEDİ
1100119	ONKA - 4172	Ray Taşıyıcı Sac Krom	6,17	100

ALÜMİNYUM



ÜRÜN KODU	CİNSİ	ADET (t)	KUTU ADEDİ
ONKA - 4161	Ray Taşıyıcı Alüminyum	6,17	100

W OTOMAT RAYI İZOLASYON APARATI



YENİ KOD	ESKİ KOD	CİNSİ	ADET (t)	KUTU ADEDİ
1080136	ONKA-2137	35'lik İzolasyon Aparatı (1 m)	12,50	100

RAY KESME MAKASI



ÜRÜN KODU	CİNSİ	ADET	KUTU ADEDİ
MRK-1	1 çeşit ray (35x7,5) keser ve raya Ø 5,5 mm delik deler.	1	1
MRK-2	2 çeşit ray (35x7,5 - 35x15) keser ve raya Ø 5,5 mm delik deler.	1	1
MRK-5	3 çeşit ray (5,5x15-7,5x35-15x35) ve 3x30 mm bakır barayı keser. Raya Ø 5,5 mm delik deler ve Ø 8 mm tij keser.	1	1



SIKMALI KABLO PABUÇLARI

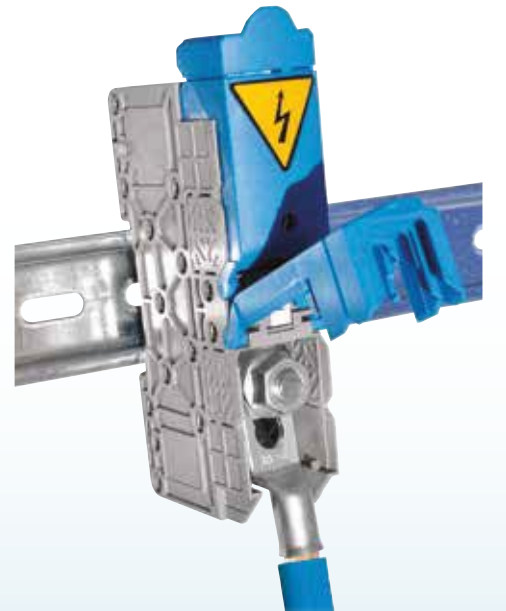

Civata sökmeden
kolay montaj imkanı.

EN 61238-1

STANDART SKP SIKMALI KABLO PABUÇLARI (BAKIR)

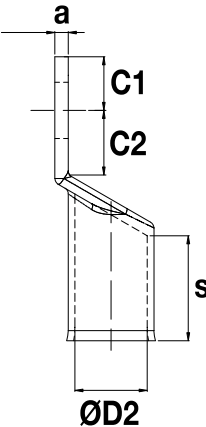
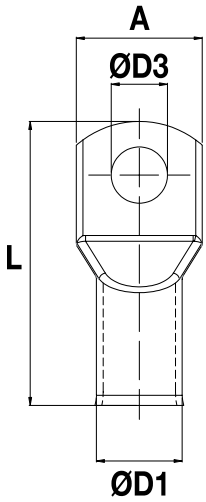

ESKİ KOD	KABLO KESİTİ (mm ²)	YENİ KOD	CIVATA (Ø)	ØD1 (mm)	ØD2 (mm)	L (mm)	ØD3 (mm)	A (mm)	C1 (mm)	C2 (mm)	a (mm)	s (mm)	GR	ADET (t)	KUTU ADEDİ
ONKA-6250	6	1090348	M5	5,5	4	24	5,5	7,9	6	5	1,5	9	2	3,83	1500
		1090349	M6	5,5	4	24	6,5	7,9	6	5	1,5	9			
ONKA-6251	10	1090351	M5	6,5	5	24,9	5,3	9,4	5,7	6,3	1,5	9	2,5	4,36	1250
		1090352	M6	6,5	5	24,9	6,5	9,4	5,7	6,3	1,5	9			
ONKA-6252	16	1090356	M6	7	5,5	27,7	6,5	10,3	6,4	5,6	1,5	10	3	5,03	750
		1090357	M8	7	5,5	28,3	8,5	12,7	6,4	6,7	1	10			
ONKA-6253	25	1090360	M6	9	7,5	34	6,5	13,4	7,5	8,5	1,5	11,5	5	7,66	450
		1090361	M8	9	7,5	34	8,4	13,4	7,5	8,5	1,5	11,5			
ONKA-6254	35	1090365	M6	10,5	8,5	39	6,5	15,6	8,7	9,3	2	14	9	12,99	300
		1090366	M8	10,5	8,5	39	8,5	15,6	8,7	9,3	2	14			
		1090367	M10	10,5	8,5	39	10,5	15,6	8,7	9,3	2	14			
ONKA-6255	50	1090370	M8	12	10	46,6	8,5	17,8	10,3	11,2	2	17	13	17,17	175
		1090371	M10	12	10	46,6	10,5	17,8	10,3	11,2	2	17			
		1090372	M12	12	10	46,6	13	17,8	10,3	11,2	2	17			
		1090373	M14	12	10	46,6	14,5	17,8	10,3	11,2	2	17			
ONKA-6256	70	1090376	M8	14	11,5	49,2	8,5	20,4	10,7	10,8	2,5	17	20	26,19	125
		1090377	M10	14	11,5	49,2	10,5	20,4	10,7	10,8	2,5	17			
		1090378	M12	14	11,5	49,2	13	20,4	10,7	10,8	2,5	17			
		1090379	M14	14	11,5	49,2	14,5	20,4	10,7	10,8	2,5	17			
ONKA-6257	95	1090382	M8	16	13,5	53,5	10,5	23,7	10,3	11,7	2,5	21	24	33,69	75
		1090383	M10	16	13,5	53,5	13	23,7	10,3	11,7	2,5	21			
		1090384	M12	16	13,5	53,5	14,5	23,7	10,3	11,7	2,5	21			
		1090385	M14	16	13,5	53,5	17	23,7	10,3	11,7	2,5	21			
ONKA-6258	120	1090391	M10	18	15,5	64	10,5	27	13,7	13,3	2,5	24	36	46,71	50
		1090392	M12	18	15,5	64	13	27	13,7	13,3	2,5	24			
		1090393	M14	18	15,5	64	14,5	27	13,7	13,3	2,5	24			
		1090394	M16	18	15,5	64	17	27	13,7	13,3	2,5	24			
ONKA-6259	150	1090399	M10	20	16,5	71,2	10,5	29,4	17,4	16,6	3,5	24	59	77,27	40
		1090400	M12	20	16,5	71,2	13	29,4	17,4	16,6	3,5	24			
		1090401	M14	20	16,5	71,2	14,5	29,4	17,4	16,6	3,5	24			
		1090402	M16	20	16,5	71,2	17	29,4	17,4	16,6	3,5	24			
ONKA-6260	185	1090407	M10	22	18,5	77	10,5	32,4	17,4	17,6	3,5	27	69	92,72	30
		1090408	M12	22	18,5	77	13	32,4	17,4	17,6	3,5	27			
		1090409	M14	22	18,5	77	14,5	32,4	17,4	17,6	3,5	27			
		1090410	M16	22	18,5	77	17	32,4	17,4	17,6	3,5	27			
		1090412	M20	22	18,5	77	20,5	32,4	17,4	17,6	3,5	27			
ONKA-6261	240	1090416	M10	25,5	21,5	83,5	10,5	37,6	17,4	17,6	4	32	107	129,99	25
		1090417	M12	25,5	21,5	83,5	13	37,6	17,4	17,6	4	32			
		1090418	M14	25,5	21,5	83,5	14,5	37,6	17,4	17,6	4	32			
		1090419	M16	25,5	21,5	83,5	17	37,6	17,4	17,6	4	32			
		1090421	M20	25,5	21,5	83,5	20,5	37,6	17,4	17,6	4	32			

LONG BOY SKP SIKMALI KABLO PABUÇLARI (BAKIR)

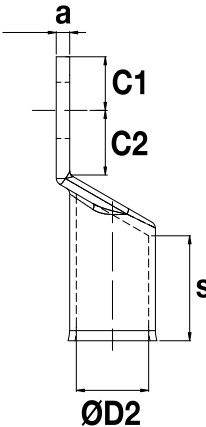
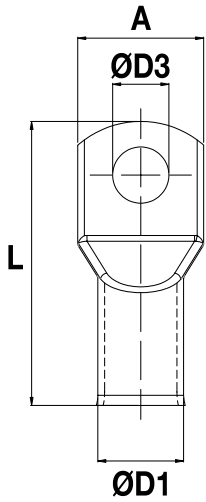

ESKİ KOD	KABLO KESİTİ (mm ²)	YENİ KOD	CIVATA (Ø)	ØD1 (mm)	ØD2 (mm)	L (mm)	ØD3 (mm)	A (mm)	C1 (mm)	C2 (mm)	a (mm)	s (mm)	GR	ADET (t)	KUTU ADEDİ
ONKA-6401	6	1090002	M5	5,5	4	25,7	5,5	7,9	6	5	1,5	11	2	4,00	1500
		1090003	M6	5,5	4	25,7	6,5	7,9	6	5	1,5	11			
ONKA-6402	10	1090005	M5	6,5	5	27,3	5,5	11,2	5,6	6,4	1,5	11	2,5	4,51	1000
		1090006	M6	6,5	5	27,3	6,5	11,2	5,6	6,4	1,5	11			
ONKA-6403	16	1090435	M6	7	5,5	29,7	6,5	10,3	5,6	6,4	1,5	14	3,5	5,55	600
		1090436	M8	7	5,5	31	8,5	12,7	5,6	6,9	1,1	14			
ONKA-6404	25	1090439	M6	9	7,5	40	6,5	13,4	7,3	8,3	1,5	16	6	8,83	300
		1090440	M8	9	7,5	40	8,5	13,4	7,3	8,3	1,5	16			
ONKA-6405	35	1090444	M6	10,5	8,5	43,3	6,5	15,6	8,6	9,4	2	19	10	14,28	250
		1090445	M8	10,5	8,5	43,3	8,5	15,6	8,6	9,4	2	19			
		1090446	M10	10,5	8,5	43,3	10,5	15,6	8,6	9,4	2	19			
ONKA-6406	50	1090449	M8	12	10	51,2	8,5	17,8	10,5	11	2	22	15	19,37	150
		1090450	M10	12	10	51,2	10,5	17,8	10,5	11	2	22			
		1090451	M12	12	10	51,2	13	17,8	10,5	11	2	22			
		1090452	M14	12	10	51,2	14,5	17,8	10,5	11	2	22			
ONKA-6407	70	1090455	M8	14	11,5	55	8,5	20,4	10,5	11	2,9	24	23	29,35	100
		1090456	M10	14	11,5	55	10,5	20,4	10,5	11	2,9	24			
		1090457	M12	14	11,5	55	13	20,4	10,5	11	2,9	24			
		1090458	M14	14	11,5	55	14,5	20,4	10,5	11	2,9	24			
ONKA-6408	95	1090461	M8	16	13,5	59,6	8,5	23,7	10,5	11,5	2,6	27	30	37,54	75
		1090462	M10	16	13,5	59,6	10,5	23,7	10,5	11,5	2,6	27			
		1090463	M12	16	13,5	59,6	13	23,7	10,5	11,5	2,6	27			
		1090464	M14	16	13,5	59,6	14,5	23,7	10,5	11,5	2,6	27			
ONKA-6409	120	1090470	M10	18	15,5	70,6	10,5	27	13,6	13,4	2,6	32	39	50,78	50
		1090471	M12	18	15,5	70,6	13	27	13,6	13,4	2,6	32			
		1090472	M14	18	15,5	70,6	14,5	27	13,6	13,4	2,6	32			
		1090473	M16	18	15,5	70,6	17	27	13,6	13,4	2,6	32			
ONKA-6410	150	1090478	M10	20	16,5	77,6	10,5	29,4	17,6	16,4	3,4	30	63	81,17	40
		1090479	M12	20	16,5	77,6	13	29,4	17,6	16,4	3,4	30			
		1090480	M14	20	16,5	77,6	14,5	29,4	17,6	16,4	3,4	30			
		1090481	M16	20	16,5	77,6	17	29,4	17,6	16,4	3,4	30			
ONKA-6411	185	1090486	M10	22	18,5	85	10,5	32,4	17,6	17,4	3,5	35	78	98,76	30
		1090487	M12	22	18,5	85	13	32,4	17,6	17,4	3,5	35			
		1090488	M14	22	18,5	85	14,5	32,4	17,6	17,4	3,5	35			
		1090489	M16	22	18,5	85	17	32,4	17,6	17,4	3,5	35			
		1090491	M20	22	18,5	85	20,5	32,4	17,6	17,4	3,5	35			
ONKA-6412	240	1090495	M10	25,5	21,5	90	10,5	37,6	17,6	17,4	4	40	106	137,03	25
		1090496	M12	25,5	21,5	90	13	37,6	17,6	17,4	4	40			
		1090497	M14	25,5	21,5	90	14,5	37,6	17,6	17,4	4	40			
		1090498	M16	25,5	21,5	90	17	37,6	17,6	17,4	4	40			
		1090500	M20	25,5	21,5	90	20,5	37,6	17,6	17,4	4	40			

EXTRA STANDART SKP SIKMALI KABLO PABUÇLARI (UZUN ve KALIN TİP) (BAKIR)

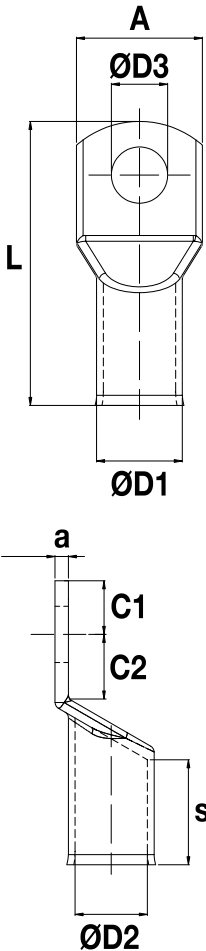

ESKİ KOD	KABLO KESİTİ (mm ²)	YENİ KOD	CIVATA (Ø)	ØD1 (mm)	ØD2 (mm)	L (mm)	ØD3 (mm)	A (mm)	C1 (mm)	C2 (mm)	a (mm)	s (mm)	GR	ADET (t)	KUTU ADEDİ
ONKA-6025	6	1090002	M5	5,5	4	25,7	5,5	7,9	6	5	1,5	11	2	4,00	1500
		1090003	M6	5,5	4	25,7	6,5	7,9	6	5	1,5	11			
ONKA-6026	10	1090005	M5	6,5	5	27,3	5,5	9,5	5,6	6,4	1,5	11	3	4,51	1000
		1090006	M6	6,5	5	27,3	6,5	9,5	5,6	6,4	1	11			
ONKA-6027	16	1090010	M6	7,8	5,8	29,7	6,5	11,2	5,6	6,4	2	13	4	7,34	600
		1090011	M8	7,8	5,8	33,5	8,5	14	7,8	6,8	1,5	13			
ONKA-6028	25	1090014	M6	9,5	7,2	40	6,5	13,5	7,3	8,3	2,3	17	10	12,82	300
		1090015	M8	9,5	7,2	40	8,5	13,5	7,3	8,3	2,3	17			
ONKA-6029	35	1090019	M6	10,8	8,5	43,3	6,5	15,7	8,6	9,4	2,3	18	12	18,14	250
		1090020	M8	10,8	8,5	43,3	8,5	15,7	8,6	9,4	2,3	18			
		1090021	M10	10,8	8,5	43,3	10,5	15,7	8,6	9,4	2,3	18			
ONKA-6030	50	1090024	M8	13	10	51,2	8,5	18,7	10,5	11	3	22	21	28,90	150
		1090025	M10	13	10	51,2	10,5	18,7	10,5	11	3	22			
		1090026	M12	13	10	51,2	13	18,7	10,5	11	3	22			
		1090027	M14	13	10	51,2	14,5	18,7	10,5	11	3	22			
ONKA-6031	70	1090030	M8	14,7	11,5	55	8,5	21,2	10,5	11	3,2	23	30	38,66	100
		1090031	M10	14,7	11,5	55	10,5	21,2	10,5	11	3,2	23			
		1090033	M14	14,7	11,5	55	14,5	21,2	10,5	11	3,2	23			
ONKA-6032	95	1090036	M8	16,7	13,5	59,6	8,5	24,5	10,5	11,5	3,2	25	37	46,36	75
		1090037	M10	16,7	13,5	59,6	10,5	24,5	10,5	11,5	3,2	25			
		1090038	M12	16,7	13,5	59,6	13	24,5	10,5	11,5	3,2	25			
		1090039	M14	16,7	13,5	59,6	14,5	24,5	10,5	11,5	3,2	25			
ONKA-6033	120	1090045	M10	19	15,6	70,6	10,5	28	13,6	13,4	3,4	32	52	68,18	50
		1090046	M12	19	15,6	70,6	13	28	13,6	13,4	3,4	32			
		1090047	M14	19	15,6	70,6	14,5	28	13,6	13,4	3,4	32			
		1090048	M16	19	15,6	70,6	17	28	13,6	13,4	3,4	32			
ONKA-6034	150	1090053	M10	21	17	77,6	10,5	30,6	17,6	16,4	4	32	74	93,42	40
		1090054	M12	21	17	77,6	13	30,6	17,6	16,4	4	32			
		1090055	M14	21	17	77,6	14,5	30,6	17,6	16,4	4	32			
ONKA-6035	185	1090061	M10	23	19	85	10,5	34	17,6	17,4	4	35	92	117,41	30
		1090062	M12	23	19	85	13	34	17,6	17,4	4	35			
		1090063	M14	23	19	85	14,5	34	17,6	17,4	4	35			
		1090064	M16	23	19	85	17	34	17,6	17,4	4	35			
ONKA-6036	240	1090066	M20	23	19	85	20,5	34	17,6	17,4	4	35	133	172,68	25
		1090070	M10	26	21	90	10,5	37,8	17,6	17,4	5	35			
		1090071	M12	26	21	90	13	37,8	17,6	17,4	5	35			
		1090072	M14	26	21	90	14,5	37,8	17,6	17,4	5	35			
		1090073	M16	26	21	90	17	37,8	17,6	17,4	5	35			
ONKA-6037	300	1090075	M20	26	21	90	20,5	37,8	17,6	17,4	5	35	181	259,88	10
		1090078	M14	29	23,5	103	14,5	42	21,2	14,8	5,1	35			
		1090079	M16	29	23,5	103	17	42	21,2	14,8	5,1	35			
		1090081	M20	29	23,5	103	20,5	42	21,2	14,8	5,1	35			
ONKA-6038	400	1090084	M14	32,8	27	125	14,5	47,5	24	16	5,8	36	282	367,57	10
		1090085	M16	32,8	27	125	17	47,5	24	16	5,8	36			
		1090087	M20	32,8	27	125	20,5	47,5	24	16	5,8	36			

DIN NORMU 46235 TİP SKP SIKMALI KABLO PABUÇLARI (BAKIR)

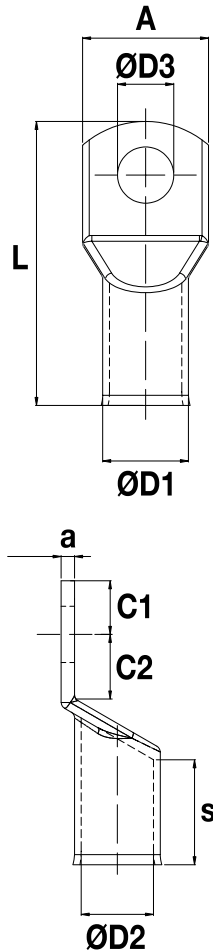

ESKİ KOD	KABLO KESİTİ (mm ²)	YENİ KOD	CIVATA (Ø)	ØD1 (mm)	ØD2 (mm)	L (mm)	ØD3 (mm)	A (mm)	C1 (mm)	C2 (mm)	a (mm)	s (mm)	GR	ADET (t)	KUTU ADEDİ
ONKA-6052	10	1090104	M5	6,5	5	34	5,5	9,5	7	8,5	1,5	13	3	5,06	800
ONKA-6053		1090105	M6	6,5	5	34	6,5	9,5	7	8,5	1,5	13			
ONKA-6054	16	1090109	M6	8,5	5,5	46	6,5	13	10	8	2	21	11	15,95	300
ONKA-6055		1090110	M8	8,5	5,5	46	8,5	13	10	10	2	21			
ONKA-6056		1090111	M10	8,5	5,5	46	10,5	13	10	12	2	21			
ONKA-6057	25	1090114	M6	10	7	48	6,5	16	10	8	3	21	13	20,20	250
ONKA-6058		1090115	M8	10	7	48	8,5	16	10	10	3	21			
ONKA-6059		1090116	M10	10	7	48	10,5	16	10	12	3	21			
ONKA-6106		1090117	M12	10	7	48	13	16	10	13	3	21			
ONKA-6061	35	1090121	M8	12,5	8,2	54	8,5	19	12	10	4,3	22	29	38,97	150
ONKA-6062		1090122	M10	12,5	8,2	54	10,5	19	12	12	4,3	22			
ONKA-6063		1090123	M12	12,5	8,2	54	13	19	12	13	4,3	22			
ONKA-6064	50	1090126	M8	14,5	10	64	8,5	21,5	12	10	4,5	31	44	56,93	75
ONKA-6065		1090127	M10	14,5	10	64	10,5	21,5	12	12	4,5	31			
ONKA-6066		1090128	M12	14,5	10	64	13	21,5	12	13	4,5	31			
ONKA-6067		1090130	M16	14,5	10	64	17	21,5	12	16	4,5	31			
ONKA-6068	70	1090133	M8	16,5	11,5	68	8,5	23,8	13	10	5	32	62	75,63	75
ONKA-6069		1090134	M10	16,5	11,5	68	10,5	23,8	13	12	5	32			
ONKA-6070		1090135	M12	16,5	11,5	68	13	23,8	13	13	5	32			
ONKA-6072		1090137	M16	16,5	11,5	68	17	23,8	13	16	5	32			
ONKA-6074	95	1090141	M10	19	13,5	78,5	10,5	27	14	12	5,5	40	90	112,18	40
ONKA-6075		1090142	M12	19	13,5	78,5	13	27	14	14	5,5	40			
ONKA-6077		1090144	M16	19	13,5	78,5	17	27	14	16	5,5	40			
ONKA-6078	120	1090149	M10	21	15,5	86	10,5	30	16,5	16	5,5	40	112	139,99	40
ONKA-6079		1090150	M12	21	15,5	86	13	30	16,5	16,5	5,5	40			
ONKA-6081		1090152	M16	21	15,5	86	17	30	16,5	20	5,5	40			
ONKA-6082		1090154	M20	21	15,5	86	20,5	30	16,5	22	5,5	40			
ONKA-6083	150	1090158	M10	23,5	17	94	10,5	34	16	16	6,5	40	160	199,85	25
ONKA-6084		1090159	M12	23,5	17	94	13	34	16	17	6,5	40			
ONKA-6086		1090161	M16	23,5	17	94	17	34	16	20	6,5	40			
ONKA-6087		1090163	M20	23,5	17	94	20,5	34	16	22	6,5	40			
ONKA-6088	185	1090167	M10	25,5	19	98	10,5	37	16	16	6,5	40	188	228,84	20
ONKA-6089		1090168	M12	25,5	19	98	13	37	16	17	6,5	40			
ONKA-6091		1090170	M16	25,5	19	98	17	37	16	20	6,5	40			
ONKA-6092	240	1090172	M20	25,5	19	98	20,5	37	16	22	6,5	40	223	328,34	15
ONKA-6094		1090177	M12	29	21,5	108	13	42	16	17	7,5	55			
ONKA-6096		1090179	M16	29	21,5	108	17	42	16	20	7,5	55			
ONKA-6097	300	1090181	M20	29	21,5	108	20,5	42	16	22	7,5	55	-	403,34	10
ONKA-6098		1090184	M14	32	24,5	119	14,5	48	19	22	7,5	55			
ONKA-6099		1090185	M16	32	24,5	119	17	48	19	22	7,5	55			
ONKA-6100	400	1090187	M20	32	24,5	119	20,5	48	19	22	7,5	55	-	907,31	10
ONKA-6101		1090192	M14	38,5	27,5	140	14,5	55	19	22	11	60			
ONKA-6102		1090193	M16	38,5	27,5	140	17	55	19	22	11	60			
ONKA-6103	500	1090195	M20	38,5	27,5	140	20,5	55	19	22	11	60	-	1.137,24	1
ONKA-6104		1090203	M20	-	-	-	20,5	-	-	-	-	-			
ONKA-6105	625	1090211	M20	-	-	-	20,5	-	-	-	-	-	-	1.242,82	1

45° SIKMALI KABLO PABUÇLARI

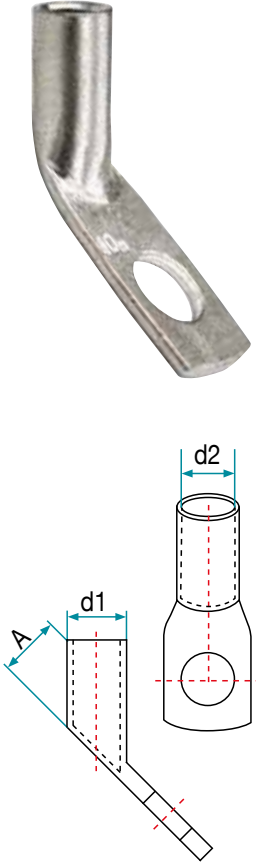

ÜRÜN KODU	CIVATA (Ø)	KABLO KESİTİ (mm ²)	İÇ ÇAP (d1) (mm)	DIŞ ÇAP (d2) (mm)	KABLO BOYU (A)	ADET (t)	KUTU ADEDİ
ONKA-6304	M 5	6	4.00	5.50	9.50	Ⓢ	800
ONKA-6305	M 5/6	10	4.50	6.00	11.50		500
ONKA-6306	M 6/8/10	16	5.50	7.50	12.50		300
ONKA-6307	M 8/10	25	7.00	9.50	15.50		200
ONKA-6308	M 8/10	35	8.50	11.00	17.00		125
ONKA-6309	M 10/12	50	10.00	13.00	18.50		80
ONKA-6310	M 10/12	70	11.50	14.50	22.00		60
ONKA-6311	M 10/12/14	95	13.50	16.50	24.00		40
ONKA-6312	M 10/12/14	120	14.50	18.00	27.00		30
ONKA-6313	M 10/12/16	150	16.50	21.00	29.00		25
ONKA-6314	M 10/12/16	185	18.50	23.00	32.00		20
ONKA-6315	M 10/12/16	240	21.00	26.00	37.00		15
ONKA-6316	M 12/16	300	23.50	28.50	39.00		8

90° SIKMALI KABLO PABUÇLARI

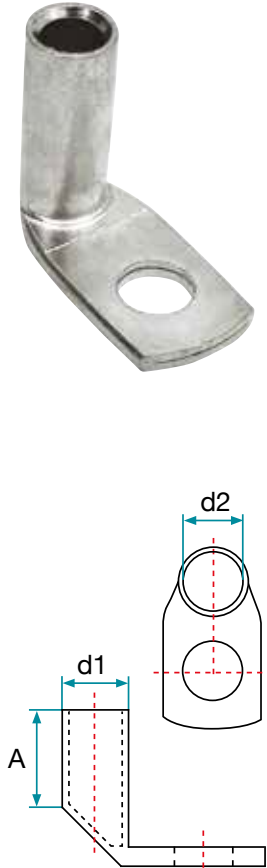

ÜRÜN KODU	CIVATA (Ø)	KABLO KESİTİ (mm ²)	İÇ ÇAP (d1) (mm)	DIŞ ÇAP (d2) (mm)	KABLO BOYU (A)	ADET (t)	KUTU ADEDİ
ONKA-6319	M 5	6	4.00	5.50	9.50	Ⓢ	800
ONKA-6320	M 5/6	10	4.50	6.00	11.50		500
ONKA-6321	M 6/8/10	16	5.50	7.50	12.50		300
ONKA-6322	M 8/10	25	7.00	9.50	15.50		200
ONKA-6323	M 8/10	35	8.50	11.00	17.00		150
ONKA-6324	M 10/12	50	10.00	13.00	18.50		80
ONKA-6325	M 10/12	70	11.50	14.50	22.00		60
ONKA-6326	M 10/12/14	95	13.50	16.50	24.00		50
ONKA-6327	M 10/12/14	120	14.50	18.00	27.00		30
ONKA-6328	M 10/12/16	150	16.50	21.00	29.00		25
ONKA-6329	M 10/12/16	185	18.50	23.00	32.00		20
ONKA-6330	M 10/12/16	240	21.00	26.00	37.00		15
ONKA-6331	M 12/16	300	23.50	28.50	39.00		8

ÇATAL TİP SIKMALI KABLO PABUÇLARI

Cıvataları tam sökmeden kolay montaj

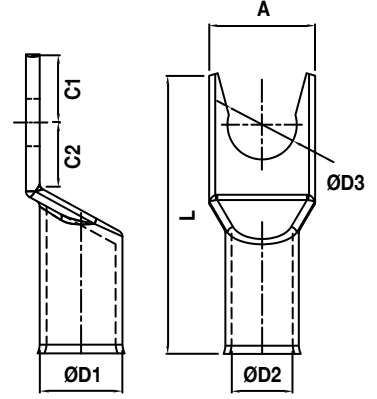

ESKİ KOD	KABLO KESİTİ (mm ²)	YENİ KOD	CIVATA (Ø)	ØD1 (mm)	ØD2 (mm)	L (mm)	ØD3 (mm)	A (mm)	C1 (mm)	C2 (mm)	ADET (t)	KUTU ADEDİ
ONKA-6210	10	1090331	M5	6,5	5	25	5,5	9,5	5,5	6,5	4,99	1250
ONKA-6211	16	1090332	M6	7	5,5	27,5	6,5	10,5	5,5	6,5	5,69	750
ONKA-6212	25	1090333	M8	9	7,5	34	8,5	13	7	9	8,21	450
ONKA-6213	35	1090334	M8	10,5	8,5	39	8,5	15,5	8,5	9,5	13,46	300
ONKA-6214	50	1090335	M8	12	10	47	8,5	18	10	11,5	17,55	175

ALÜMİNYUM DIN NORMU SKP SIKMALI KABLO PABUÇLARI

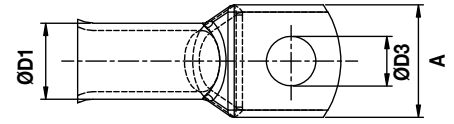
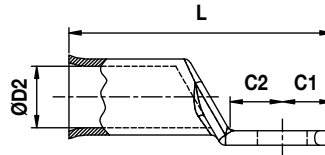

ESKİ KOD	KABLO KESİTİ (mm ²)	YENİ KOD	CIVATA (Ø)	ØD1 (mm)	ØD2 (mm)	L (mm)	ØD3 (mm)	A (mm)	C1 (mm)	C2 (mm)	ADET (t)	KUTU ADEDİ
ONKA-6122	10	1090215	M5	8	5	50	5,5	9	7	8,5	6,09	300
ONKA-6123	16	1090221	M8	10	6	53	8,4	13,7	10	10	8,22	200
ONKA-6124	25	1090225	M8	12	7	62	8,4	16	10	10	10,40	100
ONKA-6125	35	1090231	M10	14	8,2	70	10,5	19	12	12	14,06	75
ONKA-6126	50	1090235	M10	16	10	80	10,5	22	12	12	17,87	50
ONKA-6127	70	1090241	M10	18	12	90	10,5	24	12	12	22,82	40
ONKA-6128	95	1090249	M12	22	13,4	95	13	28	13	13	37,27	25
ONKA-6129	120	1090257	M12	23	15	110	13	32	16	17	46,05	20
ONKA-6130	150	1090266	M12	26	16,5	114	13	34	16	17	55,87	15
ONKA-6131	185	1090272	M12	28	18,5	125	13	37	16	17	66,47	10
ONKA-6132	240	1090280	M12	32	20	140	13	42	16	17	91,12	8

KAYNAKLI TİP SKP

DIN 46234 Standartı,
Bakır Malzemededen
Kalay Kaplı

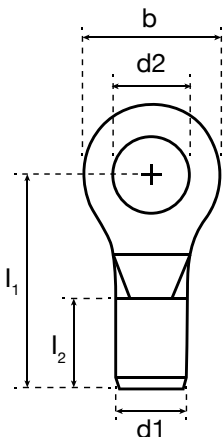

KABLO KESİTİ (mm ²)	ÜRÜN KODU	CIVATA (Ø)	Ød1 (mm)	l ₁ (mm)	b (mm)	l ₂ (mm)	d2 (mm)	ADET (t)	KUTU ADEDİ
0.5 - 1	ONKA-102002	M3	1.6	10.8	6.0	4.8	3.2		1000
	ONKA-102004	M3.5	1.6	10.8	6.0	4.8	3.7		1000
	ONKA-102006	M4	1.6	11.8	8.0	4.8	4.3		1000
	ONKA-102008	M5	1.6	12.8	10.0	4.8	5.3		1000
	ONKA-102010	M6	1.6	14.8	11.0	4.8	6.5		1000
	ONKA-102011	M8	1.6	17.0	14.0	4.8	8.4		1000
1.5 - 2.5	ONKA-102012	M3	2.3	10.8	6.0	4.8	3.2		1000
	ONKA-102014	M3.5	2.3	10.8	6.0	4.8	3.7		1000
	ONKA-102016	M4	2.3	11.8	8.0	4.8	4.3		1000
	ONKA-102018	M5	2.3	13.8	10.0	4.8	5.3		1000
	ONKA-102020	M6	2.3	15.8	11.0	4.8	6.5		1000
	ONKA-102022	M8	2.3	16.8	14.0	4.8	8.4		1000
4 - 6	ONKA-102023	M10	2.3	17.0	15.0	4.8	10.5		1000
	ONKA-102024	M4	3.6	14.0	8.0	6.0	4.3		100
	ONKA-102026	M5	3.6	15.0	10.0	6.0	5.3		100
	ONKA-102028	M6	3.6	16.0	11.0	6.0	6.5		100
	ONKA-102030	M8	3.6	19.0	14.0	6.0	8.4		100
	ONKA-102032	M10	3.6	21.0	18.0	6.0	10.5		100
10	ONKA-102033	M12	3.6	21.0	18.0	6.0	13.0		100
	ONKA-102036	M5	4.5	16.0	10.0	8.0	5.3		100
	ONKA-102038	M6	4.5	17.0	11.0	8.0	6.5	100	
	ONKA-102040	M8	4.5	20.0	14.0	8.0	8.4	100	
	ONKA-102042	M10	4.5	21.0	18.0	8.0	10.5	100	
	ONKA-102044	M12	4.5	23.0	22.0	8.0	13.0	100	
16	ONKA-102046	M5	5.8	20.0	11.0	10.0	5.3	100	
	ONKA-102048	M6	5.8	20.0	11.0	10.0	6.5	100	
	ONKA-102050	M8	5.8	22.0	14.0	10.0	8.4	100	
	ONKA-102052	M10	5.8	24.0	18.0	10.0	10.5	100	
	ONKA-102054	M12	5.8	26.0	22.0	10.0	13.0	100	
	25	ONKA-102056	M5	7.5	25.0	12.0	11.0	5.3	100
ONKA-102058		M6	7.5	25.0	12.0	11.0	6.5	100	
ONKA-102060		M8	7.5	25.0	16.0	11.0	8.4	100	
ONKA-102062		M10	7.5	26.0	18.0	11.0	10.5	100	
ONKA-102064		M12	7.5	31.0	22.0	11.0	13.0	100	
ONKA-102068		M16	7.5	35.0	28.0	11.0	17.0	100	
35	ONKA-102070	M6	9.0	26.0	15.0	12.0	6.5	100	
	ONKA-102072	M8	9.0	26.0	16.0	12.0	8.4	100	
	ONKA-102074	M10	9.0	27.0	18.0	12.0	10.5	100	
	ONKA-102076	M12	9.0	31.0	22.0	12.0	13.0	100	
	ONKA-102080	M16	9.0	35.0	28.0	12.0	17.0	100	
	50	ONKA-102082	M6	11.0	34.0	18.0	16.0	6.5	100
ONKA-102084		M8	11.0	34.0	18.0	16.0	8.4	100	
ONKA-102086		M10	11.0	34.0	18.0	16.0	10.5	100	
ONKA-102088		M12	11.0	36.0	22.0	16.0	13.0	100	
ONKA-102092		M16	11.0	40.0	22.0	16.0	17.0	100	
70		ONKA-102093	M6	15.0	38.0	22.0	18.0	6.5	100
	ONKA-102094	M8	15.0	38.0	22.0	18.0	8.4	100	
	ONKA-102096	M10	15.0	38.0	22.0	18.0	10.5	100	
	ONKA-102098	M12	15.0	38.0	22.0	18.0	13.0	100	
	ONKA-102102	M16	15.0	42.0	28.0	18.0	17.0	100	
	95	ONKA-102103	M8	15.0	42.0	24.0	20.0	8.4	100
ONKA-102104		M10	15.0	42.0	24.0	20.0	10.5	100	
ONKA-102106		M12	15.0	42.0	24.0	20.0	13.0	100	
ONKA-102110		M16	15.0	44.0	28.0	20.0	17.0	100	
120	ONKA-102111	M8	16.5	44.0	24.0	22.0	8.4	50	
	ONKA-102112	M10	16.5	44.0	24.0	22.0	10.5	50	
	ONKA-102114	M12	16.5	44.0	24.0	22.0	13.0	50	
	ONKA-102118	M16	16.5	48.0	28.0	22.0	17.0	50	
150	ONKA-102120	M10	19.0	50.0	30.0	24.0	10.5	50	
	ONKA-102123	M12	19.0	50.0	30.0	24.0	13.0	50	
	ONKA-102126	M16	19.0	50.0	30.0	24.0	17.0	50	
185	ONKA-102128	M12	21.0	50.0	36.0	28.0	13.0	50	
	ONKA-102132	M16	21.0	50.0	36.0	28.0	17.0	50	
240	ONKA-102134	M12	23.5	56.0	38.0	32.0	13.0	50	
	ONKA-102138	M16	23.5	56.0	38.0	32.0	17.0	50	



STANDART SIKMALI EK MUFLAR (BAKIR)

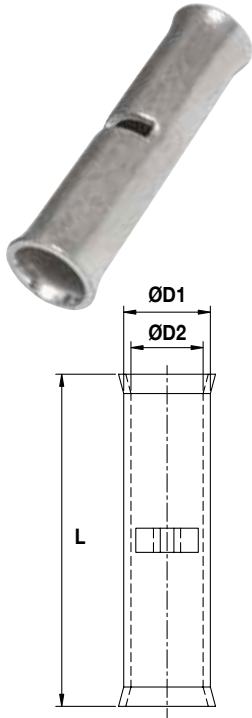

YENİ KOD	ESKİ KOD	KABLO KESİTİ (mm ²)	ØD1 (mm)	ØD2 (mm)	L (mm)	ADET (t)	KUTU ADEDİ
1090288	ONKA - 6141	10	6.5	5	25.5	5,36	750
1090289	ONKA - 6142	16	7	5.5	28	6,19	500
1090290	ONKA - 6143	25	9	7.5	34.5	9,05	300
1090291	ONKA - 6144	35	10.5	8.5	39.5	14,99	200
1090292	ONKA - 6145	50	12	10	47.5	19,99	150
1090293	ONKA - 6146	70	14	11.5	49.5	29,26	100
1090294	ONKA - 6147	95	16	13.5	53.5	36,08	75
1090295	ONKA - 6148	120	18	15.5	64	49,93	50
1090296	ONKA - 6149	150	20	16.5	70	82,17	35
1090297	ONKA - 6150	185	22	18.5	75	96,80	25
1090298	ONKA - 6151	240	25.5	21.5	83.5	141,14	15

EKSTRA STANDART UZUN ve KALIN TİP SIKMALI EK MUFLAR (BAKIR)

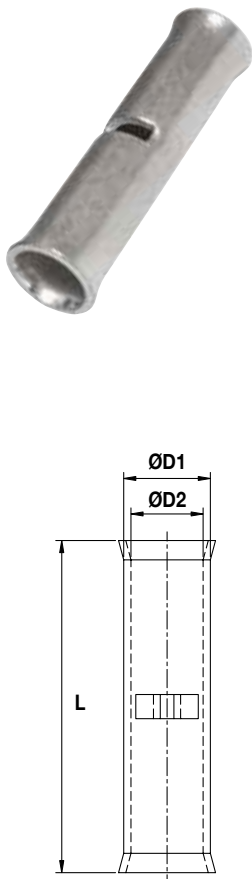

YENİ KOD	ESKİ KOD	KABLO KESİTİ (mm ²)	ØD1 (mm)	ØD2 (mm)	L (mm)	ADET (t)	KUTU ADEDİ
1090299	ONKA - 6160	6	5.5	4	26.5	4,71	1000
1090300	ONKA - 6161	10	6.5	5	28	5,30	750
1090301	ONKA - 6162	16	7.8	5.8	30.5	8,31	500
1090302	ONKA - 6163	25	9.5	7.2	40.5	14,16	400
1090303	ONKA - 6164	35	10.8	8.5	44	19,87	250
1090304	ONKA - 6165	50	13	10	50	30,61	150
1090305	ONKA - 6166	70	14.7	11.5	55.5	41,77	100
1090306	ONKA - 6167	95	16.7	13.5	59.5	49,41	75
1090307	ONKA - 6168	120	19	15.6	65	67,32	50
1090308	ONKA - 6169	150	21	17	70	91,40	35
1090309	ONKA - 6170	185	23	19	75	112,86	25
1090310	ONKA - 6171	240	26	21	85	174,91	20
1090311	ONKA - 6172	300	28.6	23.5	100	264,66	12
1090312	ONKA - 6173	400	32.8	27	110	378,83	10
1090313	ONKA - 6174	500	-	-	-	Ⓢ	10
1090314	ONKA - 6175	625	-	-	-	Ⓢ	10

DIN NORMU 46235 TİP SIKMALI EK MUFLAR (BAKIR)

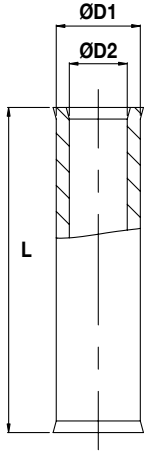

YENİ KOD	ESKİ KOD	KABLO KESİTİ (mm ²)	ØD1 (mm)	ØD2 (mm)	L (mm)	ADET (t)	KUTU ADEDİ
1090316	ONKA - 6181	10	6,5	5,0	30	5,42	400
1090317	ONKA - 6182	16	8,5	5,5	50	18,92	250
1090318	ONKA - 6183	25	10,0	7,0	50	22,79	125
1090319	ONKA - 6184	35	12,5	8,2	50	38,84	100
1090320	ONKA - 6185	50	14,5	10,0	56	53,26	100
1090321	ONKA - 6186	70	16,5	11,5	56	67,62	50
1090322	ONKA - 6187	95	19,0	13,5	70	105,95	40
1090323	ONKA - 6188	120	21,0	15,5	70	119,39	30
1090324	ONKA - 6189	150	23,5	17,0	80	180,88	20
1090325	ONKA - 6190	185	25,5	19,0	85	209,82	10
1090326	ONKA - 6191	240	29,0	21,5	90	290,88	10
1090327	ONKA - 6192	300	32	24,5	100	⊕	10
1090328	ONKA - 6193	400	38,5	27,5	150	⊕	10
1090329	ONKA - 6194	500	-	-	-	⊕	10
1090330	ONKA - 6195	625	-	-	-	⊕	10

ALÜMİNYUM DIN NORMU SIKMALI EK MUFLAR

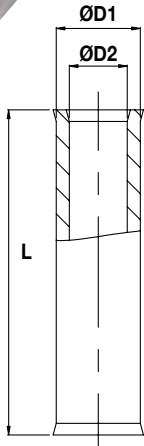

YENİ KOD	ESKİ KOD	KABLO KESİTİ (mm ²)	ØD1 (mm)	ØD2 (mm)	L (mm)	ADET (t)	KUTU ADEDİ
1090422	ONKA - 6270	10	8	5	52	4,74	300
1090423	ONKA - 6271	16	10	6	55	6,29	250
1090424	ONKA - 6272	25	12	7	64	9,12	150
1090425	ONKA - 6273	35	14	8,2	72	12,75	75
1090426	ONKA - 6274	50	16	10	82	16,86	50
1090427	ONKA - 6275	70	18	12	92	20,96	35
1090428	ONKA - 6276	95	22	13,4	97	35,96	20
1090429	ONKA - 6277	120	23	15	112	42,04	15
1090430	ONKA - 6278	150	26	16,5	116	60,04	8
1090431	ONKA - 6279	185	28	18,5	127	70,45	7
1090432	ONKA - 6280	240	32	20	142	106,66	5



**YÜKSEK SAFLIKTA
BAKIRDAN DÖVME TEKNİĞİ
İLE ÜRETİLMİŞTİR.**

**BİMETAL (Cu/Al)
BAĞLANTI APARATLARI**



BAKIR ALÜMİNYUMLU SKP (Bimetal)

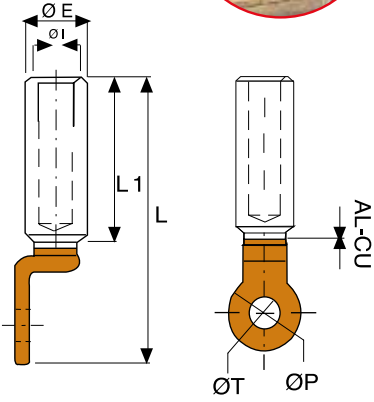

ÜRÜN KODU	KABLO KESİTİ (mm ²)	ØE (mm)	ØI (mm)	L (mm)	ØT (mm)	L1 (mm)	ADET (\$)	KUTU ADEDİ
ONKA-6108	16	20	6,5	84	12,8	46	3,20 \$	80
ONKA-6109	25	20	6,5	84	12,8	46	3,20 \$	80
ONKA-6110	35	20	8	84	12,8	46	3,20 \$	80
ONKA-6111	50	20	9	84	12,8	46	4,20 \$	60
ONKA-6112	70	20	11	84	12,8	46	4,20 \$	60
ONKA-6113	95	20	12,5	84	12,8	46	4,20 \$	60
ONKA-6114	120	25	13,7	107	12,8	62,5	6,50 \$	30
ONKA-6115	150	25	15,5	107	12,8	62,5	6,50 \$	30
ONKA-6116	185	32	17	117	14,5	64	10,70 \$	15
ONKA-6117	240	32	19,5	117	14,5	64	10,70 \$	15
ONKA-6118	300	36	23,3	157	16,3	90	17,50 \$	9
ONKA-6119	400	36	26	157	16,3	90	17,50 \$	9

BAKIR ALÜMİNYUMLU SKP (Bimetal Uzun Tip)

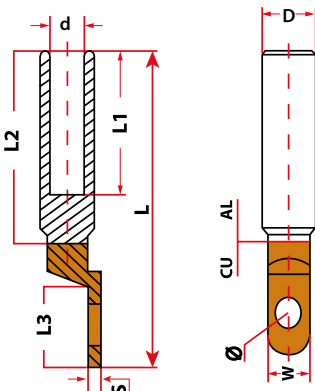

ÜRÜN KODU	KABLO KESİTİ (mm ²)	D (mm)	d (mm)	L±1 (mm)	L1 (mm)	L2 (mm)	L3 (mm)	W (mm)	Q (mm)	S (mm)	ADET (\$)	KUTU ADEDİ
ONKA-6510	16	16	5,5	82	38	50	23	14,0	8,5	3,2	2,65 \$	80
ONKA-6511	25	16	6,5	82	38	50	23	14,0	8,5	3,2	2,65 \$	80
ONKA-6512	35	16	8,2	82	38	50	23	14,0	8,5	3,2	2,65 \$	80
ONKA-6513	50	20	9,7	94	43	55	27	16,0	8,5	5,2	3,60 \$	60
ONKA-6514	70	20	11	94	43	55	27	16,0	8,5	5,2	3,60 \$	60
ONKA-6515	95	20	12,5	94	43	55	27	16,0	8,5	5,2	3,60 \$	60
ONKA-6516	120	25	14,5	120	60	72	32	23,0	10,5	6,5	6,05 \$	30
ONKA-6517	150	25	16,5	120	60	72	32	23,0	10,5	6,5	6,05 \$	30
ONKA-6518	185	32	17,5	133	60	73	38	23,0	12,5	8	9,80 \$	15
ONKA-6519	240	32	19,5	133	60	73	38	29,0	12,5	8	9,80 \$	15
ONKA-6520	300	34	23	133	61	73	35	29,0	12,5	8,5	14,25 \$	10
ONKA-6521	400	40	26,2	163	93	105	35	29,0	12,5	10,5	16,20 \$	10
ONKA-6522	500	40	29	163	93	105	35	29,0	12,5	10,5	16,20 \$	10

ALÜMİNYUM-BAKIR EK MUF

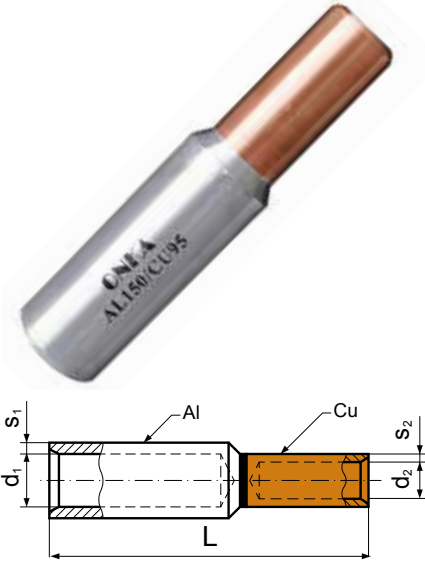

ÜRÜN KODU	AL KABLO KESİTİ (mm ²)	CU KABLO KESİTİ (mm ²)	D1 (mm)	D2 (mm)	L (mm)	ADET (\$)	KUTU ADEDİ
ONKA - 6348	16	10	5,5	5,5	75,0	1,10 \$	280
ONKA - 6349	16	16	5,5	5,5	75,0	1,20 \$	280
ONKA - 6350	25	10	5,3	7,3	80,0	1,30 \$	90
ONKA - 6351	35	16	8,0	5,5	71,0	2,00 \$	90
ONKA - 6352	50	25	9,8	5,5	71,5	2,50 \$	80
ONKA - 6353	70	35	11,2	5,5	79,0	3,40 \$	70
ONKA - 6354	95	50	13,2	5,5	79,0	5,00 \$	42
ONKA - 6355	120	70	14,7	5,5	87,0	5,60 \$	35
ONKA - 6356	150	95	16,3	5,5	93,3	6,70 \$	30
ONKA - 6357	185	120	18,3	10,0	108,0	8,60 \$	24
ONKA - 6358	240	150	21,0	10,0	116,0	13,20 \$	16

ALÜMİNYUM-BAKIR EK MUF (PİNLİ)

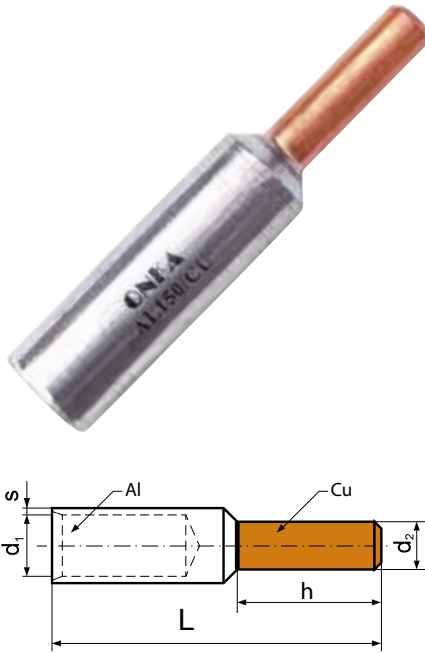

ÜRÜN KODU	KABLO KESİTİ (mm ²)		ØD1 (mm)	ØD2 (mm)	L (mm)		ADET (\$)	KUTU ADEDİ
	Çok Telli Kablo	Tek Damar Kablo			l	h		
ONKA - 6333	10	16	12	5	58	15	2,20 \$	100
ONKA - 6334	16	25	12	6	58	15	2,20 \$	100
ONKA - 6335	25	35	6,8	6	58	20	2,30 \$	50
ONKA - 6336	35	50	8,0	7	71	22	2,50 \$	50
ONKA - 6337	50	70	9,8	8	74	25	3,00 \$	80
ONKA - 6338	70	95	11,2	10	87	30	3,30 \$	70
ONKA - 6339	95	120	13,2	12	91	33	4,60 \$	48
ONKA - 6340	120	150	14,7	12	97	38	5,50 \$	35
ONKA - 6341	150	185	16,3	12	108	38	5,70 \$	30
ONKA - 6342	185	240	18,3	14	116	44	7,50 \$	24
ONKA - 6343	240	300	21,0	16	128	44	8,40 \$	16
ONKA - 6344	300	-	23,3	18	131	46	10,00 \$	9

KJB TİP BİMETAL ALÜMİNYUM-BAKIR BAĞLANTI ELEMANI

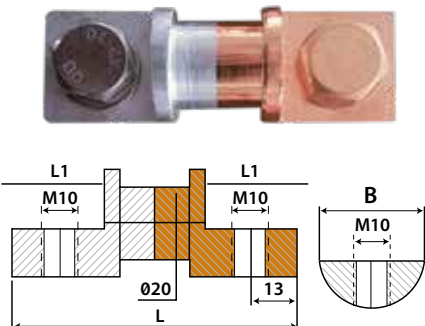

ÜRÜN KODU	VİDA (Ø)	L (mm)	L1 (mm)	B (mm)	ADET (\$)	KUTU ADEDİ
ONKA - 6530	M10	80	26	26	14,00 \$	24
ONKA - 6531	M10	80	26	29	16,00 \$	24

BİMETAL MEKANİK SIKMALI KABLO PABUCU



ÜRÜN KODU	KABLO KESİTİ (mm ²)	DIŞ ÇAP (mm)	VİDA SAYISI	UYGUN ANAHTAR	ADET (\$)	KUTU ADEDİ
BMSKP 35-150-12/2	35 - 150	28	2	17	Ⓢ	80
BMSKP 70-240-12/2	70 - 240	33	2	19		40
BMSKP 120-300-12/2	120 - 300	38	2	22		36
BMSKP 185-400-16/2	185 - 400	42	2	22		28

MEKANİK SIKMALI KABLO PABUCU (ALÜMİNYUM)



ÜRÜN KODU	KABLO KESİTİ (mm ²)	DIŞ ÇAP (mm)	VİDA SAYISI	UYGUN ANAHTAR	ADET (\$)	KUTU ADEDİ
MSKP 35-150-12/2	35 - 150	28	2	17	Ⓢ	80
MSKP 70-240-12/2	70 - 240	33	2	19		40
MSKP 120-300-16/2	120 - 300	38	2	22		36
MSKP 185-400-16/2	185 - 400	42	2	22		28

MEKANİK SIKMALI EK MUF (ALÜMİNYUM)



ÜRÜN KODU	KABLO KESİTİ (mm ²)	DIŞ ÇAP (mm)	VİDA SAYISI	UYGUN ANAHTAR	ADET (\$)	KUTU ADEDİ
MSEM 35-150/4	35 - 150	28	4	17	Ⓢ	20
MSEM 70-240/4	70 - 240	33	4	19		15
MSEM 120-300/4	120-300	38	4	22		10
MSEM 185-400/4	185 - 400	42	4	22		9
MSEM 500-630/6	400-630	52	6	24		4

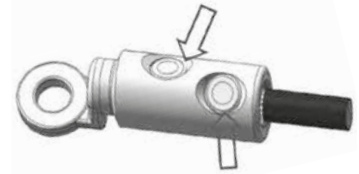
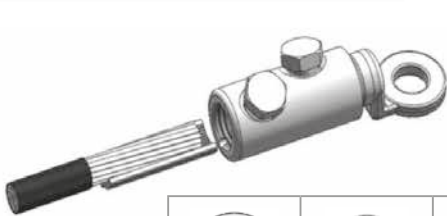

KOD	AL Daire İletken / AL	AL Dilim İletken	Cu Daire İletken / Cu	Cu Dilim İletken	Soyma Boyu	İlave Çap Büyütücü	İlave Parçasız	Cıvata Çapı	Cıvata Çapı
SKP 35-150-12/2	35-150	35-120	35-150	35-150	35-120	41	35-70	95-150	17
SKP 70-240-12/2	70-240	70-240	70-185	70-240	70-185	64	70-120	150-240	19
SKP 120-300-16/2	120-300	120-300	120-240	120-300	120-240	71	120-185	240-300	22
SKP 185-400-16/2	185-400	185-400	185-300	185-400	185-300	81	185-240	300-400	22

U KLEMENSLER

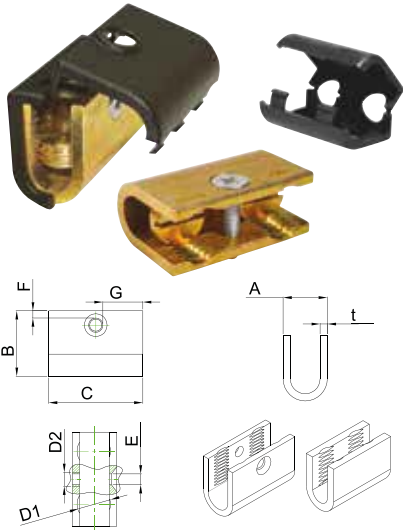

İzolasyon kapağı ürün ile birlikte verilmektedir.

ÜRÜN KODU	KABLO KESİTİ (mm ²)	VİDA	A	t	B	C	D1	D2	E	F	G	ADET (t)	KUTU ADEDİ
ONKA-7050	6	Çelik	8,5	1,8	13	19	M6	-	-	-	-	Ⓢ	300
ONKA-7051	10	Çelik	10	2,2	15	21	M8	-	-	-	-		250
ONKA-7052	16	Çelik	12,2	2,3	18,2	28	M10	-	-	-	-		150
ONKA-7053	25	Çelik	13,8	2,5	20	30,5	7/6"	M5	6	2,25	12		100
ONKA-7054	35	Çelik	14,5	2,5	23,2	32,5	M12	M5	6	2,25	13,3		75
ONKA-7055	50	Pirinç	16,2	3	25,4	39	M14	M5	6	2,75	16,6		50
ONKA-7056	70	Pirinç	19,5	3,25	28,2	43,1	M16	M5	6	4,1	18,5		40
ONKA-7057	95	Pirinç	21,6	3,25	31,9	45,5	M18	M6	6,5	3,5	19,5		30
ONKA-7058	120	Pirinç	23,5	3,4	34	50,8	M20	M6	6,5	4	22,15		20
ONKA-7059	150	Pirinç	28	4,4	39,1	53,9	M22	M6	7	4,4	23,45		10
ONKA-7060	U Klemens Kayığı											100	

TIRNAKLI KLEMENSLER

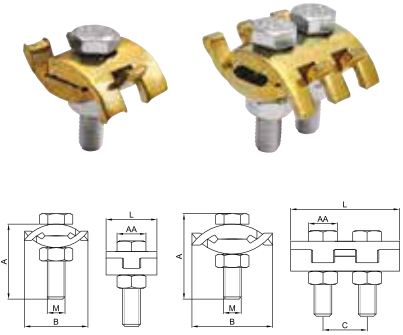

ÜRÜN KODU	CİNSİ	A	B	L	M	AA	C	ADET (t)	KUTU ADEDİ
ONKA-7070	No. 1 16 mm ²	25	22	17,2	M6	10	-	Ⓢ	500
ONKA-7071	No. 2 25 mm ²	25	26	20,2	M6	10	-		250
ONKA-7072	No. 3 35 mm ²	25	28	30,3	M6	10	15		100
ONKA-7073	No. 4 50 mm ²	25	33	32,4	M6	10	15		100
ONKA-7074	No. 5 70 mm ²	35	40	35,4	M8	13	17		100
ONKA-7075	No. 6-7 120 mm ²	35	49	45,1	M6	13	24		50

KONDANSATÖR KLEMENSLERİ



YENİ KOD	ESKİ KOD	METRİK (Ø)	A X B (mm)	D (mm)	ADET (t)	KUTU ADEDİ
1140016	ONKA-7094	M12 (Ø12,3)	25,5 x 39,2	10	Ⓢ	100
1140017	ONKA-7095	M16 (Ø16,3)	30 x 43,3	9,4		100
1140018	ONKA-7096	M14 (Ø14,5)	25,5 x 39,2	10		100
1140019	ONKA-7097	M14 (Ø14,5)	30 x 43,3	9,4		100
1140020	ONKA-7098	M12 (Ø12,3)	30 x 43,3	9,4		100

AL - CU / BRANŞMAN / DURDURUCU KLEMENSLER



SIRA KLEMENSLER



✓ SIRA KLEMENS

✓ STEATİT KLEMENS

✓ BUAT KLEMENS

✓ SOKET KLEMENS

✓ TRAFÖ KLEMENSİ

✓ MODÜL CİHAZ KLEMENSİ

✓ ASPIRATÖR KLEMENSİ

Elektrikli ev aletleri, endüstriyel cihazlar, ürün yaşam döngüsü içinde periyodik bakım , teknik servis gereksinimi, mobilizasyon kaynaklı demontaj ve montajlar gibi elektrik bağlantılarını da kapsayan işlemlerin her tekrarında güvenli bağlantıyı sağlamak esas amaçtır.

Elektrik bağlantılarının güvenli tekrarlanabilirliği için ise; sıkıştırma ünitesi ana birimleri olan vida ve kafeslerin, sertlik ve gerilme kuvvetleri özdeş metallere oluşması bizlere klasik yöntemlerin (pirinç/çelik – zamak/çelik vb.) ötesinde maksimum performans, kalite ve güvenlik kazandırmaktadır.

ONKA sıra klemenslerin kontak yapısı, özel alaşımlı Ck 45 malzemeden yüksek teknoloji insan odaklı üretim hatalarından etkilenmeyen otomasyon sistemleri ile üretilmektedir. Atmosferik ortamlardan arındırılmış özel dizayn kapalı fırınlarda 36.6 HRC kadar sertleştirilmesi sayesinde ürünün defalarca iletken bağlanıp sökülmesinden kaynaklı deformasyonlara karşı yüksek derecede dayanıklılık sağlanmıştır.

V2 Seri ürünler, gövde yapısı 140°C derece ısıya dayanıma sahip olan Polyamid 6 malzemeden üretilmektedir.

Polyamid 6 hammadde; kopma, eğilme, darbe, aşınma mukavemeti sağlar ve çekme, basma elastikiyeti yüksektir.

Tüm bu termik ve mekanik üstünlükleri ile Polyamid 6 dış ortam koşullarına karşı da maksimum dayanıklı bir ürün elde etmemizi sağlar.

TS EN 60335-1 Standartlarına uygun V0 yanmazlık seviyesinde, 200°C dayanımlı ürün serimiz; Elektrikli ev aletleri ve endüstriyel uygulamalar için özel olarak tasarlanmış yüksek ısıya dayanıklı cam elyaf katkılı PA6 gövde yapısıyla tam güvenlik sağlar. Farklı kesit - renk - vida - kovan - pin sayılarıyla proje ve ihtiyaçlarınıza özel olarak da üretilmektedir.

Kontak yapısına uygun sertlik değeri ile üretilen çelik vida ile değişken kullanım koşullarında deforme olmayan bir dayanıklılık kombinasyonu oluşturulmuştur.

ONKA Elektrik, ISO 9001-2015 kalite yönetim sistemi ile yaptığı üretimlerle, kalitesini uluslararası sertifikalar ile tescillemiştir.

Ürünlerimiz;

Uluslararası kalite gereksinimlerini tam performansla yerine getirirken , Bizlere Ülkemizin de önde gelen Beyaz eşya üreticileri, Sanayi kuruluşları , Savunma Endüstrisi ve Enerji Dağıtım şirketlerince tercih edilen marka olmanın haklı gururunu yaşatmakta, dış ticaret birimimizin faaliyetleriyle 85+ ülkede insanlığa güvenle hizmet ederken , kullanıcılarımızın kendi ürünlerinin önemli bir bileşeni olarak da Dünyanın dört bir yanına ulaşmaktadır

Referanslarımız;



- Polyamid 6+cam elyaf gövde yapısıyla yüksek sıcaklık , dielektrik ve mekanik performans.
- CK45 Kafes ve çelik vidanın Özdeş sertliğiyle uzun ve güvenli ürün yaşam döngüsü
- Özellikle son kullanıcı , insan odaklı cihaz ve tesislerin güvenliği için optimum bağlantı çözümü.
- 85+ ülkede tercih edilerek uluslararası akredite kurumlarca tescillenerek belgelenmiş yüksek KALİTE!!!

PLASTİK SIRA KLEMENSLER, VİDA BLOKAJLI - (MAVİ)



YENİ KOD	ESKİ KOD	CİNSİ	GERİLİM (V)	AKIM (A)	ADET (t)	KUTU ADEDİ
1070015	ONKA - 5000	No. 0 0,75 - 1,5 mm ² lik 12 Sıra	400	17,5	27,38	100
1070016	ONKA - 5001	No. 1 2,5 - 4 mm ² lik 12 Sıra	400	32	28,10	50
1070017	ONKA - 5002	No. 2 4 - 6 mm ² lik 12 Sıra	400	41	36,70	50
1070018	ONKA - 5003	No. 3 6 - 10 mm ² lik 10 Sıra	400	57	41,15	50
1070019	ONKA - 5004	No. 4 10 - 16 mm ² lik 6 Sıra	500	76	40,63	50
1070020	ONKA - 5005	No. 5 16 - 25 mm ² lik 6 Sıra	500	101	59,94	50

ISIYA DAYANIKLI PA6, VİDA BLOKAJLI - (BEYAZ - KIRMIZI) 140 °C V2, TSE, OSK



YENİ KOD	ESKİ KOD	CİNSİ	GERİLİM (V)	AKIM (A)	ADET (t)	KUTU ADEDİ
1070027	ONKA - 5010	No. 0 0,75 - 1,5 mm ² lik 12 Sıra	400	17,5	29,04	100
1070028	ONKA - 5011	No. 1 2,5 - 4 mm ² lik 12 Sıra	400	32	30,41	50
1070029	ONKA - 5012	No. 2 4 - 6 mm ² lik 12 Sıra	400	41	40,42	50
1070030	ONKA - 5013	No. 3 6 - 10 mm ² lik 10 Sıra	400	57	47,24	50
1070031	ONKA - 5014	No. 4 10 - 16 mm ² lik 6 Sıra	500	76	47,25	50
1070032	ONKA - 5015	No. 5 16 - 25 mm ² lik 6 Sıra	500	101	68,40	50
1070033	ONKA - 5016	No. 3 3'lü 6 - 10 mm ² lik 3 Sıra	400	57	16,39	250

ISIYA DAYANIKLI, VİDA BLOKAJLI - (ŞEFFAF - POLİKARBON)



YENİ KOD	ESKİ KOD	CİNSİ	GERİLİM (V)	AKIM (A)	ADET (t)	KUTU ADEDİ
1070034	ONKA - 5020	No. 0 0,75 - 1,5 mm ² lik 12 Sıra	400	17,5	29,23	100
1070035	ONKA - 5021	No. 1 2,5 - 4 mm ² lik 12 Sıra	400	32	31,33	50
1070036	ONKA - 5022	No. 2 4 - 6 mm ² lik 12 Sıra	400	41	42,23	50
1070037	ONKA - 5023	No. 3 6 - 10 mm ² lik 10 Sıra	400	57	48,51	50
1070038	ONKA - 5024	No. 4 10 - 16 mm ² lik 6 Sıra	500	76	47,49	50
1070039	ONKA - 5025	No. 5 16 - 25 mm ² lik 6 Sıra	500	101	68,46	50
1070040	ONKA - 5026	No. 3 3'lü 6 - 10 mm ² lik 3 Sıra	400	57	15,30	250

CAM ELYAF TAKVİYELİ, VİDA BLOKAJLI - (200° PA6-V0)



YENİ KOD	ESKİ KOD	CİNSİ	GERİLİM (V)	AKIM (A)	ADET (t)	KUTU ADEDİ
1070041	ONKA - 5029	No. 0 0,75 - 1,5 mm ² lik 12 Sıra	400	17,5	31,82	100
1070042	ONKA - 5030	No. 1 2,5 - 4 mm ² lik 12 Sıra	400	32	34,45	50
1070043	ONKA - 5031	No. 2 4 - 6 mm ² lik 12 Sıra	400	41	46,15	50
1070044	ONKA - 5032	No. 3 6 - 10 mm ² lik 10 Sıra	400	57	55,45	50
1070045	ONKA - 5033	No. 4 10 - 16 mm ² lik 6 Sıra	500	76	55,29	50
1070046	ONKA - 5034	No. 5 16 - 25 mm ² lik 6 Sıra	500	101	78,45	50
1070047	ONKA - 5035	No. 3 3'lü 6 - 10 mm ² lik 3 Sıra	400	57	17,68	250

PALETLİ ISIYA DAYANIKLI, VİDA BLOKAJLI - (BEYAZ - KIRMIZI) 140 °C V2



YENİ KOD	ESKİ KOD	CİNSİ	GERİLİM (V)	AKIM (A)	ADET (t)	KUTU ADEDİ
1070048	ONKA - 5040	No. 1 2.5 - 4 mm ² lik 12 Sıra	400	32	37,22	50
1070049	ONKA - 5041	No. 2 4 - 6 mm ² lik 12 Sıra	400	41	47,80	50
1070050	ONKA - 5042	No. 3 6 - 10 mm ² lik 10 Sıra	400	57	54,20	50
1070051	ONKA - 5043	No. 3 3'lü 6 - 10 mm ² lik 3 Sıra	400	57	17,55	250

PALETLİ ISIYA DAYANIKLI, VİDA BLOKAJLI - (ŞEFFAF - POLİKARBON)



YENİ KOD	ESKİ KOD	CİNSİ	GERİLİM (V)	AKIM (A)	ADET (t)	KUTU ADEDİ
1070052	ONKA - 5050	No. 1 2.5 - 4 mm ² lik 12 Sıra	400	32	37,54	50
1070053	ONKA - 5051	No. 2 4 - 6 mm ² lik 12 Sıra	400	41	49,02	50
1070054	ONKA - 5052	No. 3 6 - 10 mm ² lik 10 Sıra	400	57	55,22	50
1070055	ONKA - 5053	No. 3 3'lü 6 - 10 mm ² lik 3 Sıra	400	57	17,21	250

PALETLİ CAM ELYAF TAKVİYELİ, VİDA BLOKAJLI - (200 °C - PA6-V0)



YENİ KOD	ESKİ KOD	CİNSİ	GERİLİM (V)	AKIM (A)	ADET (t)	KUTU ADEDİ
1070056	ONKA - 5056	No. 1 2.5 - 4 mm ² lik 12 Sıra	400	32	40,29	50
1070057	ONKA - 5057	No. 2 4 - 6 mm ² lik 12 Sıra	400	41	53,98	50
1070058	ONKA - 5058	No. 3 6 - 10 mm ² lik 10 Sıra	400	57	62,16	50
1070059	ONKA - 5059	No. 3 3'lü 6 - 10 mm ² lik 3 Sıra	400	57	19,59	250

KLEMENS TAPASI



YENİ KOD	ESKİ KOD	CİNSİ	ADET (t)	KUTU ADEDİ
1070251	ONKA - 5071	Klemens Tapası (12'li)	0,67	100

KAPAKLI TERMİNAL KLEMENSLER 25 A

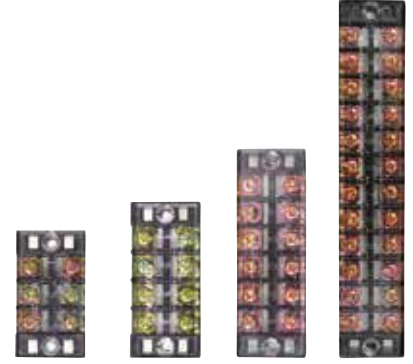

ÜRÜN KODU	CİNSİ	GERİLİM (V)	AKIM (A)	ADET (₺)	KUTU ADEDİ
ONKA - 5145	Terminal - 3	600	25	11,40	50
ONKA - 5146	Terminal - 4			14,75	50
ONKA - 5147	Terminal - 6			22,55	50
ONKA - 5148	Terminal - 12			41,80	25

TRAFO KLEMENSLERİ

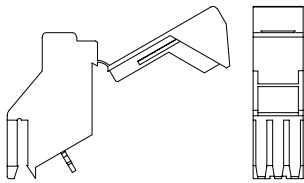

ÜRÜN KODU	CİNSİ	GERİLİM (V)	AKIM (A)	ADET (₺)	KUTU ADEDİ
ONKA - 5135	1 x 4 mm ² Yüksek Tip	400	24	100	200
ONKA - 5136	2 x 4 mm ² Yüksek Tip	400	24		100
ONKA - 5137	1 x 6 mm ² Yüksek Tip	400	41		100

TRAFO KLEMENS ETİKETLERİ



YENİ KOD	ESKİ KOD	CİNSİ	ADET (₺)	KUTU ADEDİ
1060204	ONKA - 5139	Trafo Klemens Etiketi Yazısız	0,40	500
1060205	ONKA - 5140	Trafo Klemens Etiketi Yazılı	0,88	500

MINİ KLEMENS (Aspiratör Klemensi)



RENK	YENİ KOD	ESKİ KOD	CİNSİ	GERİLİM (V)	AKIM (A)	ADET (t)	KUTU ADEDİ
⇒	1070257	ONKA - 5130	Mini klemens (Aspiratör) 2,5 - 4 mm ²	400	32	5,83	250
→	1070258	ONKA - 5131					

2'Lİ MODÜLER SİSTEM SOKET KLEMENSLER (MS 58 PİRİNÇ İLETKEN - 24 A)



RENK	YENİ KOD	ESKİ KOD	CİNSİ	GERİLİM (V)	AKIM (A)	ADET (t)	KUTU ADEDİ
⇒	1070173	ONKA - 5068	NO. 1 - 2'li Soket Klemensi + Modüler Sistem (2,5 - 4mm ²)	450	24	22,79	180
→	1070174	ONKA - 5451					
→	1070175	ONKA - 5452					
→	1070176	ONKA - 5453					
→	1070177	ONKA - 5454					

12'Lİ SOKET KLEMENS (MS 58 PİRİNÇ İLETKEN - 24 A)



RENK	YENİ KOD	ESKİ KOD	CİNSİ	GERİLİM (V)	AKIM (A)	ADET (t)	KUTU ADEDİ
⇒	1070153	ONKA - 5060	No. 1-12 2.5 - 4 mm ² lik (Erkek Dişi Geçmeli Kilitli) (İstenilen Modül sayısında kesim yapılır.)	450	24	113,08	30
→	1070154	ONKA - 5401					
→	1070155	ONKA - 5402					
→	1070156	ONKA - 5403					
→	1070157	ONKA - 5404					
→	1070158	ONKA - 5405					

3'LÜ SOKET KLEMENS (MS 58 PİRİNÇ İLETKEN - 24 A)



RENK	YENİ KOD	ESKİ KOD	CİNSİ	GERİLİM (V)	AKIM (A)	ADET (t)	KUTU ADEDİ
⇨	1070160	ONKA - 5065	NO. 1 3'lü Soket Klemensi (2,5 - 4mm ²)	450	24	35,10	100
⇨	1070161	ONKA - 5411					
⇨	1070164	ONKA - 5066	Soket Klemensi Kapağı (Takım)			16,52	45
⇨	1070166	ONKA - 5421					
⇨	1070167	ONKA - 5067	NO. 1 3'lü Soket Klemensi + Kapak Takımı (2,5 - 4mm ²)			57,42	45
⇨	1070168	ONKA - 5431					

3'LÜ SOKET KLEMENS T BAĞLANTI APARATI (MS 58 PİRİNÇ İLETKEN - 24 A)



RENK	YENİ KOD	ESKİ KOD	CİNSİ	GERİLİM (V)	AKIM (A)	ADET (t)	KUTU ADEDİ
⇨	1070254	ONKA - 5074	2,5 - 4 mm ² T Bağlantı Aparatı	450	24	77,72	60
⇨	1070255	ONKA - 5075					

6'LI SOKET KLEMENS BAĞLANTI APARATI (MS 58 PİRİNÇ İLETKEN - 24 A)



RENK	YENİ KOD	ESKİ KOD	CİNSİ	GERİLİM (V)	AKIM (A)	ADET (t)	KUTU ADEDİ
⇨	1070171	ONKA - 5064	No:1, 2,5 - 4 mm ² 6'lı soket kapak takım	450	24	100,29	16
⇨	1070170	ONKA - 5063					

MODÜL CİHAZ KLEMENSLERİ



Renkler



RENK	YENİ KOD	ESKİ KOD	cinsi	AKIM (A)	GERİLİM (V)	ADET (t)	KUTU ADEDİ
●	1070182	ONKA - 5100	No 1 (2,5 - 4 mm ²)	32 A	400 V	7,67	250
●	1070196	ONKA - 5101	No 2 (4 - 6 mm ²)	41 A	400 V	9,93	144
●	1070204	ONKA - 5102	No 3 (6 - 10 mm ²)	57 A	400 V	14,86	75
●	1070188	ONKA - 5103	No 1-3'lü (2,5 - 4 mm ²)	32 A	400 V	11,58	200
●	1070186	ONKA - 5163	No 1 (2,5 - 4 mm ²)	32 A	400 V	7,67	250
●	1070200	ONKA - 5183	No 2 (4 - 6 mm ²)	41 A	400 V	9,93	144
●	1070207	ONKA - 5193	No 3 (6 - 10 mm ²)	57 A	400 V	14,86	75
●	1070192	ONKA - 5173	No 1-3'lü (2,5 - 4 mm ²)	32 A	400 V	11,58	200
●	1070187	ONKA - 5164	No 1 (2,5 - 4 mm ²)	32 A	400 V	7,67	250
●	1070201	ONKA - 5184	No 2 (4 - 6 mm ²)	41 A	400 V	9,93	144
●	1070208	ONKA - 5194	No 3 (6 - 10 mm ²)	57 A	400 V	14,86	75
●	1070193	ONKA - 5174	No 1-3'lü (2,5 - 4 mm ²)	32 A	400 V	11,58	200
●	1070184	ONKA - 5161	No 1 (2,5 - 4 mm ²)	32 A	400 V	7,67	250
●	1070198	ONKA - 5181	No 2 (4 - 6 mm ²)	41 A	400 V	9,93	144
●	1070205	ONKA - 5191	No 3 (6 - 10 mm ²)	57 A	400 V	14,86	75
●	1070190	ONKA - 5171	No 1-3'lü (2,5 - 4 mm ²)	32 A	400 V	11,58	200
○	1070183	ONKA - 5104	No 1 (2,5 - 4 mm ²)	32 A	400 V	7,67	250
○	1070197	ONKA - 5105	No 2 (4 - 6 mm ²)	41 A	400 V	9,93	144
○	1070203	ONKA - 5106	No 3 (6 - 10 mm ²)	57 A	400 V	14,86	75
○	1070189	ONKA - 5107	No 1-3'lü (2,5 - 4 mm ²)	32 A	400 V	11,58	200
●	1070185	ONKA - 5162	No 1 (2,5 - 4 mm ²)	32 A	400 V	7,67	250
●	1070199	ONKA - 5182	No 2 (4 - 6 mm ²)	41 A	400 V	9,93	144
●	1070206	ONKA - 5192	No 3 (6 - 10 mm ²)	57 A	400 V	14,86	75
●	1070191	ONKA - 5172	No 1-3'lü (2,5 - 4 mm ²)	32 A	400 V	11,58	200

STEATİT KLEMENSLER

STEATİT KLEMENSLERİN ÜSTÜNLÜKLERİ

Steatit; elektroteknikte yalıtkan parçaların üretiminde kullanılan, klasik elektroporselene nazaran çok daha yüksek elektriksel ve mekaniksel dayanıma sahip bir malzeme olarak tanımlanabilir.

Elektrik enerjisi tüketiminin, içerisinde bulunduğumuz yüzyılda hızla artış göstermesi, üretim, iletim ve kullanım safhalarında seramik izolasyon malzemelerine olan talebi de hızla arttırmıştır. Hidroelektrik, termik, nükleer enerji v.b. gibi santrallerin dağıtım ve iletim ünitelerinde yüksek güçleri taşıyabilecek seramik izolatörlerin yanında, yüksek izolasyon sağlayabilen seramik aksam ve parçaların özelliklerinin iyileştirilmesi ihtiyacı ön plana çıkmıştır.

Elektroporselenin bu noktadan itibaren ihtiyaçlara cevap veremediği görülmüş ve 1930'lardan itibaren elektrik izolatörlerinde porselen yerine steatit kullanımı yaygınlaşmaya başlamıştır.

STEATİT KLEMENSİN PORSELEN KLEMENSE GÖRE ÜSTÜNLÜKLERİ

- Daha yüksek mekaniksel dayanıma,
- Daha yüksek boyutsal kararlılığa,
- Daha yüksek sıcaklık dayanımına (1000 °C ve üzeri),
- Daha yüksek asit dayanımına,
- Daha uzun kullanım ömrüne,
- Daha yalıtkan bir yüzeye sahip ve yüzeyel elektrik kaçağı sıfır olan, çok üstün bir malzemedir.

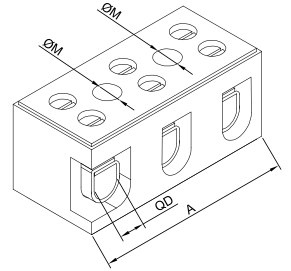
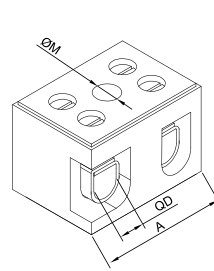
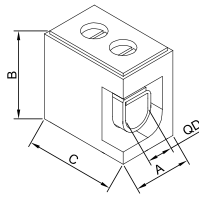

ONKA Steatit klemenslerin kontak malzemesi özel alaşımlı çeliktir ve çalışma sıcaklığı 1100 °C 'ye ulaşmaktadır. Bu da ONKA steatit klemensin çalışma sıcaklığını otomatik olarak 1000 °C'nin üzerine taşımaktadır. (Piyasadaki elektroporselen klemenslerin kontakları 350 °C'ye kadar ısıya dayanıklı olduğundan daha yüksek ısı dayanımı gerekli yerlerde kullanımı sakıncalıdır.)

YENİ KOD	ESKİ KOD	EBAT	Pole	A (mm)	B (mm)	C (mm)	D Ø (mm)	M Ø (mm)	ADET (t)	KUTU ADEDİ
1070001	ONKA-5081	No. 0/2	2	22	16,5	18,5	4	4,3	13,00	100
1070002	ONKA-5082	No. 1/2	2	22,5	17	19	5	4,3	14,56	150
1070003	ONKA-5083	No. 1/3	3	36	17	19	5	4,3	19,63	100
1070004	ONKA-5084	No. 2/2	2	27	18,5	22	6	4,3	17,21	100
1070005	ONKA-5085	No. 2/3	3	40	18,5	22	6	4,3	23,84	50
1070006	ONKA-5086	No. 3/2	2	34	24,5	30	7	5,2	30,42	50
1070007	ONKA-5087	No. 3/3	3	51,5	25	30	7	5,2	43,42	35
1070008	ONKA-5088	No. 0/1	1	11	16,5	18,5	4	-	10,86	200
1070009	ONKA-5089	No. 1/1	1	11,5	17	19	5	-	10,58	200
1070010	ONKA-5090	No. 2/1	1	12	18,8	22	6	-	12,18	150
1070011	ONKA-5091	No. 3/1	1	17	25	30,3	7	-	20,09	100
1070013	ONKA-5094	No. 4-5/3	3	65,6	30	30	11	5,2	79,28	20
1070014	ONKA-5095	No. 4-5/2	2	42	30	30	11	5,2	60,64	20

Referanslarımız;

INOXSAN

öztiryakiler

VİDALI ŞEFFAF (RENKLİ) BUAT İÇİ KLEMENS



2,5 35 mm²



YENİ KOD	ESKİ KOD	CİNSİ	GERİLİM (V)	AKIM (A)	ADET (t)	KUTU ADEDİ
1070214	ONKA - 5504	No 1 2,5-4 mm ²	400 V	32 A	2,09	600
1070221	ONKA - 5514	No 2 4-6 mm ²	400 V	41 A	2,51	600
1070228	ONKA - 5524	No 3 6-10 mm ²	400 V	57 A	3,17	600
1070235	ONKA - 5534	No 4 10-16 mm ²	500 V	76 A	4,54	500
1070242	ONKA - 5544	No 5 16-25 mm ²	500 V	101 A	7,36	500
1070248	ONKA - 5554	No 6 25-35 mm ²	500 V	125 A	16,90	200

VİDALI YİVLİ BUAT KLEMENSLERİ

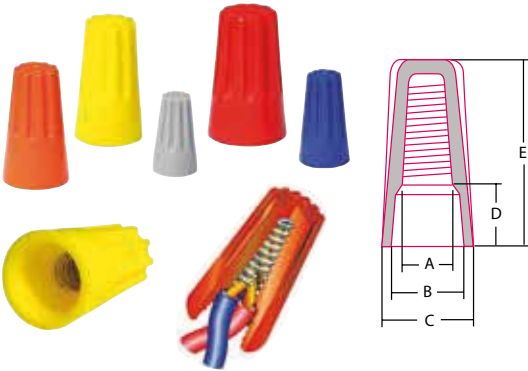

ÜRÜN KODU	RENK	A	B	C	D	E	ADET (t)	KUTU ADEDİ
ONKA - 8340 / P-1	→	3.80	6.70	8.60	5.80	15.20	Ⓢ	1000
ONKA - 8341 / P-2	→	4.10	7.00	9.80	5.90	17.60		1000
ONKA - 8342 / P-3	→	5.00	9.90	12.20	7.80	22.00		500
ONKA - 8343 / P-4	→	6.00	11.20	14.00	7.90	24.00		500
ONKA - 8344 / P-6	→	7.50	13.00	16.40	9.15	26.50		500

Dayanıklı Termoplastik hammaddeden imal edilmiş olup, UL 94 / V2 normunda 105 °C çalışma sıcaklığında, bina elektrik tesisatları için 600 V, aydınlatma ve sinyalizasyon için 1000 V'a dayanabilme özelliğine sahiptir.

YÜKSÜKLÜ BUAT KLEMENSİ (ŞEFFAF)

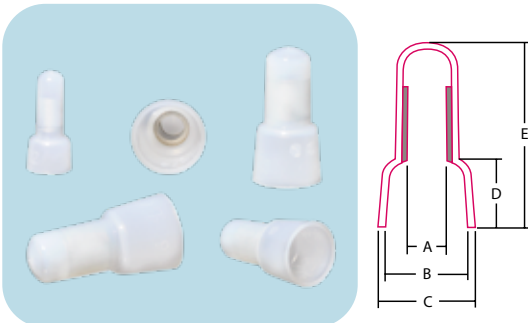

ÜRÜN KODU	A	B	C	D	E	ADET (t)	KUTU ADEDİ
ONKA - 8330 CE-1	2.6	6.2	7.8	6.2	18.0	Ⓢ	1000
ONKA - 8331 CE-2	3.1	7.9	9.5	7.2	19.7		1000
ONKA - 8332 CE-5	4.1	10.5	12.5	9.6	25.5		1000
ONKA - 8333 CE-8	5.3	12.4	14.6	12.0	27.7		500

Naylon 66 hammaddeden imal edilmiş olup, UL 94 / V2 normunda, 105 °C çalışma sıcaklığında 300 Volt Gerilime Dayanabilme özelliğine Sahiptir. (CE - 8) Modeli 600 Volt Gerilime Dayanabilme.

AÇ KAPA BUAT KLEMENSİ (TÜM KABLO ÇEŞİTLERİ İÇİN)

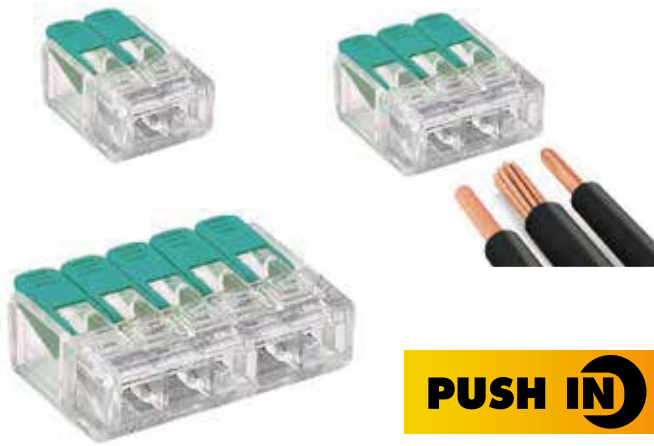

- Nominal Akım: 32 A
- Nominal Gerilim: 450 V
- 1,5–4 mm²

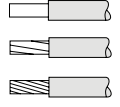

ÜRÜN KODU	AÇIKLAMA	ADET (\$)	KUTU ADEDİ
ONKA-8840	2 İletken Bağlantılı	0,22 \$	100
ONKA-8842	3 İletken Bağlantılı	0,27 \$	100
ONKA-8843	4 İletken Bağlantılı	0,33 \$	100
ONKA-8844	5 İletken Bağlantılı	0,40 \$	100

GEÇMELİ BUAT KLEMENSLER (ŞEFFAF ve RENKLİ)

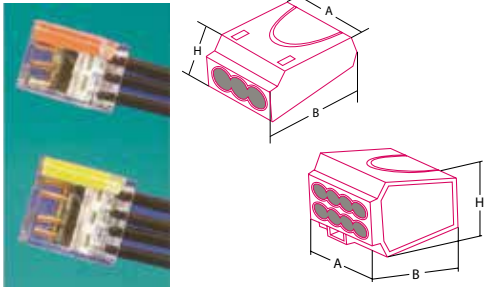

Termoplastik hammaddeden imal edilmiş olup, UL 94 / V2 normunda, 105 °C çalışma sıcaklığında 600 V elektrik iletkenliğine sahip 24 A akım geçirenliğine sahiptir.

ŞEFFAF ÜRÜN KODU	KUTUP SAYISI	KABLO KESİTİ	A	B	H	ADET (\$)	KUTU ADEDİ
ONKA - 8320	2	1.5 - 2.5 mm ²	10.5	19.5	9.5	0,13 \$	100
ONKA - 8321	3		13.5	19.7	9.5	0,16 \$	100
ONKA - 8322	4		17.2	19.7	9.5	0,19 \$	100
ONKA - 8323	5		21.1	19.7	9.5	0,22 \$	100
ONKA - 8463	6		22.0	19.7	9.5	0,25 \$	100
ONKA - 8324	8		17.5	19.0	16.8	0,28 \$	100

PRATİK BAĞLANTILI SIRA KLEMENSLER (YAY BAĞLANTILI)

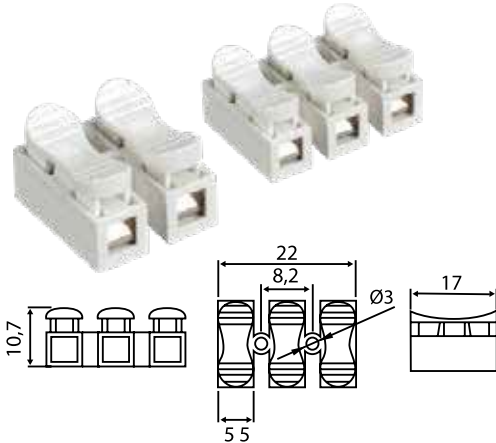

ÜRÜN KODU	AÇIKLAMA	ADET (\$)	KUTU ADEDİ
ONKA - 8850	1,5 mm ² - 2 Kutuplu Pratik Bağlantılı Sıra Klemens	0,060 \$	100
ONKA - 8851	1,5 mm ² - 3 Kutuplu Pratik Bağlantılı Sıra Klemens	0,092 \$	100
ONKA - 8852	2,5 mm ² - 2 Kutuplu Pratik Bağlantılı Sıra Klemens	0,092 \$	100
ONKA - 8853	2,5 mm ² - 3 Kutuplu Pratik Bağlantılı Sıra Klemens	0,120 \$	100
ONKA - 8854	2,5 mm ² - 12 Kutuplu Pratik Bağlantılı Sıra Klemens	0,728 \$	100
ONKA - 8855	4 mm ² - 2 Kutuplu Pratik Bağlantılı Sıra Klemens	0,244 \$	100
ONKA - 8856	4 mm ² - 3 Kutuplu Pratik Bağlantılı Sıra Klemens	0,304 \$	100

AYDINLATMA - ARMATÜR KLEMENSLERİ (YAY BAĞLANTILI)



ÜRÜN KODU	AÇIKLAMA	ADET (\$)	KUTU ADEDİ
ONKA - 8860	2 Kutup / 3 Pinli Aydınlatma-Armatür Klemensi	0,424 \$	100
ONKA - 8861	3 Kutup / 3 Pinli Aydınlatma-Armatür Klemensi	0,576 \$	100
ONKA - 8862	4 Kutup / 3 Pinli Aydınlatma-Armatür Klemensi	0,820 \$	100
ONKA - 8863	5 Kutup / 3 Pinli Aydınlatma-Armatür Klemensi	1,032 \$	100



I TİPİ PRATİK BAĞLANTI KLEMENSLERİ

ÜRÜN KODU	AÇIKLAMA	ADET (\$)	KUTU ADEDİ
 ONKA - I1	3A Beyaz 0,3 ~ 0,5 mm ²	0,40 \$	100
 ONKA - I2	10A Gri 0,6 ~ 1,0 mm ²	0,48 \$	100
 ONKA - I3	15A Sarı 1,5 mm ²	0,72 \$	100
 ONKA - I4	20A Yeşil 2,5 mm ²	1,00 \$	100
 ONKA - I5	25A Turuncu 4,0 mm ²	1,32 \$	100
 ONKA - DI - 1	3A Beyaz 0,3 ~ 0,5 mm ²	0,68 \$	100
 ONKA - DI - 2	10A Gri 0,6 ~ 1,0 mm ²	0,80 \$	100

T TİPİ PRATİK BAĞLANTI KLEMENSLERİ

ÜRÜN KODU	AÇIKLAMA	ADET (\$)	KUTU ADEDİ
 ONKA - T1	3A Beyaz 0,3 ~ 0,5 mm ²	0,48 \$	100
 ONKA - T2	10A Gri 0,6 ~ 1,0 mm ²	0,60 \$	100
 ONKA - T5	25A Turuncu 4,0 mm ²	1,52 \$	100
 ONKA - T - 21	3A Gri (T) Giriş: 0,6 ~ 1,0 mm ² (I) Çıkış: 0,2 ~ 0,5 mm ²	0,48 \$	100
 ONKA - D - 21	10A Gri 0,6 ~ 1,0 mm ²	0,88 \$	100



KABLO ve PANO AKSESUARLARI

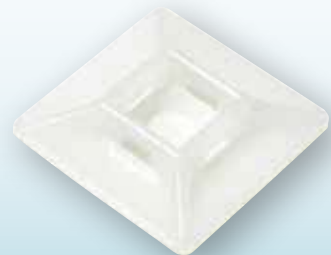

KCG TİPİ KABLO ETİKETLERİ

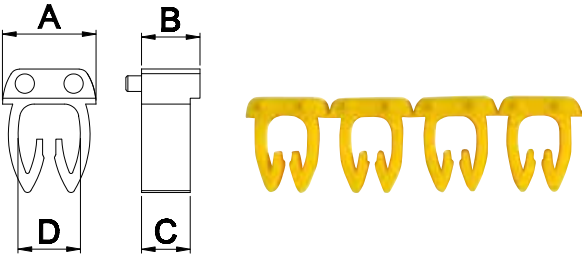

ÖLÇÜ (mm)	NO	A	B	C	D
	1	4,4	3	2,5	2,7
2	5	3	2,5	3,2	
3	7,4	3	2,5	4,9	

TEKNİK DETAY

HAMMADDE	PA6.6
ÇALIŞMA SICAKLIĞI	-40 OC, +140 OC
YAZI RENGİ	Siyah & Beyaz
UYGUN KABLO KESİTLERİ	No1 : 0,75 - 1,50 mm2 No2 : 1,50 - 2,50 mm2 No3 : 4,00 - 6,00 mm2

*Özel baskı ve renkler için

NO:1

0,75 - 1,50 mm²

YENİ KOD	ESKİ KOD	BASKI	ADET (t)	KUTU / KOLİ ADEDİ
1150006	ONKA-9848	0 BASKILI	0,189	400/20.000
1150007	ONKA-9849	1 BASKILI	0,189	400/20.000
1150013	ONKA-9852	2 BASKILI	0,189	400/20.000
1150014	ONKA-9853	3 BASKILI	0,189	400/20.000
1150015	ONKA-9854	4 BASKILI	0,189	400/20.000
1150016	ONKA-9855	5 BASKILI	0,189	400/20.000
1150017	ONKA-9856	6 BASKILI	0,189	400/20.000
1150018	ONKA-9857	7 BASKILI	0,189	400/20.000
1150019	ONKA-9858	8 BASKILI	0,189	400/20.000
1150020	ONKA-9859	9 BASKILI	0,189	400/20.000
1150027	ONKA-9866	A BASKILI	0,189	400/20.000
1150028	ONKA-9867	B BASKILI	0,189	400/20.000
1150029	ONKA-9868	C BASKILI	0,189	400/20.000
1150030	ONKA-9869	D BASKILI	0,189	400/20.000
1150031	ONKA-9870	E BASKILI	0,189	400/20.000
1150032	ONKA-9871	F BASKILI	0,189	400/20.000
1150033	ONKA-9872	G BASKILI	0,189	400/20.000
1150034	ONKA-9873	H BASKILI	0,189	400/20.000
1150035	ONKA-9874	I BASKILI	0,189	400/20.000
1150036	ONKA-9875	J BASKILI	0,189	400/20.000
1150037	ONKA-9876	K BASKILI	0,189	400/20.000
1150038	ONKA-9877	L BASKILI	0,189	400/20.000
1150040	ONKA-9879	M BASKILI	0,189	400/20.000
1150041	ONKA-9880	N BASKILI	0,189	400/20.000
1150042	ONKA-9881	O BASKILI	0,189	400/20.000
1150043	ONKA-9882	P BASKILI	0,189	400/20.000
1150045	ONKA-9884	R BASKILI	0,189	400/20.000
1150046	ONKA-9885	S BASKILI	0,189	400/20.000
1150048	ONKA-9887	T BASKILI	0,189	400/20.000
1150049	ONKA-9888	U BASKILI	0,189	400/20.000
1150050	ONKA-9889	V BASKILI	0,189	400/20.000
1150051	ONKA-9890	W BASKILI	0,189	400/20.000
1150052	ONKA-9891	X BASKILI	0,189	400/20.000
1150053	ONKA-9892	Y BASKILI	0,189	400/20.000
1150054	ONKA-9893	Z BASKILI	0,189	400/20.000
1150039	ONKA-9878	Mp BASKILI	0,189	400/20.000
1150024	ONKA-9863	+ BASKILI	0,189	400/20.000
1150021	ONKA-9860	- BASKILI	0,189	400/20.000
1150047	ONKA-9886	± BASKILI	0,189	400/20.000
1150023	ONKA-9862	~ BASKILI	0,189	400/20.000
1150044	ONKA-9883	Q BASKILI	0,189	400/20.000
1150026	ONKA-9865	AC BASKILI	0,189	400/20.000

NO:2
1,50 - 2,50 mm²

YENİ KOD	ESKİ KOD	BASKI	ADET (t)	KUTU / KOLİ ADEDİ
1150004	ONKA-9846	0 BASKILI	0,215	400/20.000
1150005	ONKA-9847	1 BASKILI	0,215	400/20.000
1150057	ONKA-9896	2 BASKILI	0,215	400/20.000
1150058	ONKA-9897	3 BASKILI	0,215	400/20.000
1150059	ONKA-9898	4 BASKILI	0,215	400/20.000
1150060	ONKA-9899	5 BASKILI	0,215	400/20.000
1150061	ONKA-9900	6 BASKILI	0,215	400/20.000
1150062	ONKA-9901	7 BASKILI	0,215	400/20.000
1150063	ONKA-9902	8 BASKILI	0,215	400/20.000
1150064	ONKA-9903	9 BASKILI	0,215	400/20.000
1150072	ONKA-9911	A BASKILI	0,215	400/20.000
1150073	ONKA-9912	B BASKILI	0,215	400/20.000
1150074	ONKA-9913	C BASKILI	0,215	400/20.000
1150075	ONKA-9914	D BASKILI	0,215	400/20.000
1150076	ONKA-9915	E BASKILI	0,215	400/20.000
1150077	ONKA-9916	F BASKILI	0,215	400/20.000
1150078	ONKA-9917	G BASKILI	0,215	400/20.000
1150079	ONKA-9918	H BASKILI	0,215	400/20.000
1150080	ONKA-9919	I BASKILI	0,215	400/20.000
1150081	ONKA-9920	J BASKILI	0,215	400/20.000
1150082	ONKA-9921	K BASKILI	0,215	400/20.000
1150086	ONKA-9925	L BASKILI	0,215	400/20.000
1150088	ONKA-9927	M BASKILI	0,215	400/20.000
1150089	ONKA-9928	N BASKILI	0,215	400/20.000
1150090	ONKA-9929	O BASKILI	0,215	400/20.000
1150091	ONKA-9930	P BASKILI	0,215	400/20.000
1150093	ONKA-9932	R BASKILI	0,215	400/20.000
1150094	ONKA-9933	S BASKILI	0,215	400/20.000
1150096	ONKA-9935	T BASKILI	0,215	400/20.000
1150097	ONKA-9936	U BASKILI	0,215	400/20.000
1150098	ONKA-9937	V BASKILI	0,215	400/20.000
1150099	ONKA-9938	W BASKILI	0,215	400/20.000
1150100	ONKA-9939	X BASKILI	0,215	400/20.000
1150101	ONKA-9940	Y BASKILI	0,215	400/20.000
1150102	ONKA-9941	Z BASKILI	0,215	400/20.000
1150087	ONKA-9926	Mp BASKILI	0,215	400/20.000
1150068	ONKA-9907	+ BASKILI	0,215	400/20.000
1150065	ONKA-9904	- BASKILI	0,215	400/20.000
1150095	ONKA-9934	± BASKILI	0,215	400/20.000
1150067	ONKA-9906	~ BASKILI	0,215	400/20.000
1150092	ONKA-9931	Q BASKILI	0,215	400/20.000
1150071	ONKA-9910	AC BASKILI	0,215	400/20.000

NO:3
4,00 - 6,00 mm²

YENİ KOD	ESKİ KOD	BASKI	ADET (t)	KUTU / KOLİ ADEDİ
1150002	ONKA-9844	0 BASKILI	0,290	400/20.000
1150003	ONKA-9845	1 BASKILI	0,290	400/20.000
1150105	ONKA-9944	2 BASKILI	0,290	400/20.000
1150106	ONKA-9945	3 BASKILI	0,290	400/20.000
1150107	ONKA-9946	4 BASKILI	0,290	400/20.000
1150108	ONKA-9947	5 BASKILI	0,290	400/20.000
1150109	ONKA-9948	6 BASKILI	0,290	400/20.000
1150110	ONKA-9949	7 BASKILI	0,290	400/20.000
1150111	ONKA-9950	8 BASKILI	0,290	400/20.000
1150112	ONKA-9951	9 BASKILI	0,290	400/20.000
1150119	ONKA-9958	A BASKILI	0,290	400/20.000
1150120	ONKA-9959	B BASKILI	0,290	400/20.000
1150121	ONKA-9960	C BASKILI	0,290	400/20.000
1150122	ONKA-9961	D BASKILI	0,290	400/20.000
1150123	ONKA-9962	E BASKILI	0,290	400/20.000
1150124	ONKA-9963	F BASKILI	0,290	400/20.000
1150125	ONKA-9964	G BASKILI	0,290	400/20.000
1150126	ONKA-9965	H BASKILI	0,290	400/20.000
1150127	ONKA-9966	I BASKILI	0,290	400/20.000
1150128	ONKA-9967	J BASKILI	0,290	400/20.000
1150129	ONKA-9968	K BASKILI	0,290	400/20.000
1150130	ONKA-9969	L BASKILI	0,290	400/20.000
1150132	ONKA-9971	M BASKILI	0,290	400/20.000
1150133	ONKA-9972	N BASKILI	0,290	400/20.000
1150134	ONKA-9973	O BASKILI	0,290	400/20.000
1150135	ONKA-9974	P BASKILI	0,290	400/20.000
1150137	ONKA-9976	R BASKILI	0,290	400/20.000
1150138	ONKA-9977	S BASKILI	0,290	400/20.000
1150140	ONKA-9979	T BASKILI	0,290	400/20.000
1150141	ONKA-9980	U BASKILI	0,290	400/20.000
1150142	ONKA-9981	V BASKILI	0,290	400/20.000
1150143	ONKA-9982	W BASKILI	0,290	400/20.000
1150144	ONKA-9983	X BASKILI	0,290	400/20.000
1150145	ONKA-9984	Y BASKILI	0,290	400/20.000
1150146	ONKA-9985	Z BASKILI	0,290	400/20.000
1150131	ONKA-9970	Mp BASKILI	0,290	400/20.000
1150116	ONKA-9955	+ BASKILI	0,290	400/20.000
1150113	ONKA-9952	- BASKILI	0,290	400/20.000
1150139	ONKA-9978	± BASKILI	0,290	400/20.000
1150115	ONKA-9954	~ BASKILI	0,290	400/20.000
1150136	ONKA-9975	Q BASKILI	0,290	400/20.000
1150001	ONKA-9843	AC BASKILI	0,290	400/20.000

PANO ETİKETLERİ (YAPIŞKANLI ve VİDALANABİLİR)

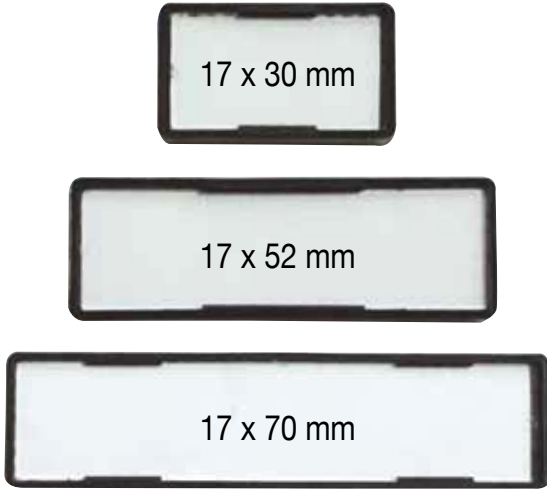

YENİ KOD	ESKİ KOD	CİNSİ	ADET (t)	KUTU ADEDİ
1130001	ONKA-7114	17 x 30 mm	2,69	100
1130002	ONKA-7115	17 x 52 mm	3,22	100
1130003	ONKA-7116	17 x 70 mm	3,80	50

METRELİK PANO ETİKETİ (YAPIŞKANLI)



YENİ KOD	ESKİ KOD	CİNSİ	ADET (€)	KUTU ADEDİ
1130007	ONKA-7126	15 x 1000 mm Yapışkanlı Pano Etiketi	5,46 €	50

METRELİK PANO ETİKETİ (YAPIŞKANLI)

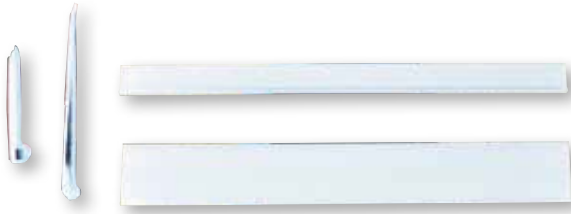

ÜRÜN KODU	CİNSİ	ADET (t)	KUTU ADEDİ
İRYPE-20200	20 x 2000 mm Yapışkanlı Pano Etiketi		200
İRYPE-30200	30 x 2000 mm Yapışkanlı Pano Etiketi		150
İRYPE-40200	40 x 2000 mm Yapışkanlı Pano Etiketi		120

KABLolar İÇİN İŞARETLEME ETİKET YATAĞI



RENK	YENİ KOD	ESKİ KOD	CİNSİ	ADET (t)	KUTU ADEDİ
→	1150154	ONKA-7134	2.5 - 3.6 mm Kablo bağları ile bağlanabilir. DB5 mm Klemens etiketleri kullanılabilir. Şeffaf daralan makoronla tam izolasyon yapılabilir.	1,64	100
→	1150155	ONKA-7135			
→	1150156	ONKA-7136			
→	1150157	ONKA-7137			
→	1150158	ONKA-7138			
→	1150159	ONKA-7139			

KABLO BAĞI TUTUCULARI (YAPIŞKANLI ve VİDALI)

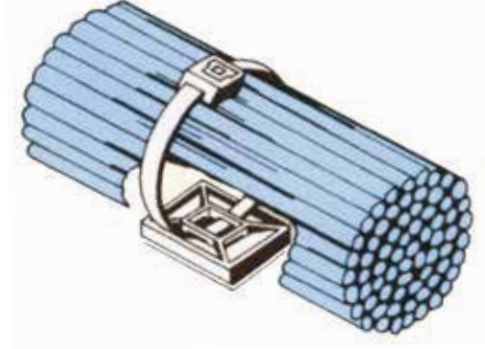
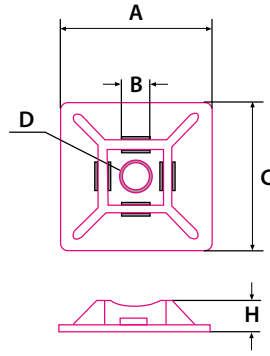

Bant Özelliği ; 1 mm Kalınlık - 120 °C ısı dayanımı - 96 kg/m³ yoğunluk - max. 60 dk'da tam yapışkanlık.

ÜRÜN KODU	A	C	B	D	H	ADET (t)	KUTU ADEDİ
ONKA - 8391 / 3A	19	19	3.6	Ø3.2	4.0	0,74	100
ONKA - 8392 / 4A	28	28	4.8	Ø3.2	4.5	1,24	100

ÇOK AMAÇLI BÜYÜK DURDURUCU

CİNSİ	KUTU ADEDİ	RENK	YENİ KOD	ESKİ KOD	ADET (t)	ÜRÜN KODU (V0)	ADET (V0) (t)
Çok Amaçlı Büyük Durdurucu	200		İRPAY-1001	-	Ⓢ	-	-



UYGULAMA YERİ

W OTOMAT ÖRTME APARATI (12'Lİ)



RENK	YENİ KOD	ESKİ KOD	CİNSİ	ADET (t)	KUTU ADEDİ
RAL 9001	1140021	ONKA-7121	W Otomat Örtme Aparatı	20,28	50
RAL 7035	1140022	ONKA-7122			
RAL 7032	1140024	ONKA-7124			

W OTOMAT ÖRTME APARATI (2 METRE)



ÜRÜN KODU	RENK	CİNSİ	ADET (t)	KUTU ADEDİ
İRWCP9001	RAL 9001	2 mt. Örtü Plakası	Ⓢ	60
İRWCP7035	RAL 7035			
İRWCP7032	RAL 7032			

KABLO BAĞI ETİKET TAŞIYICI

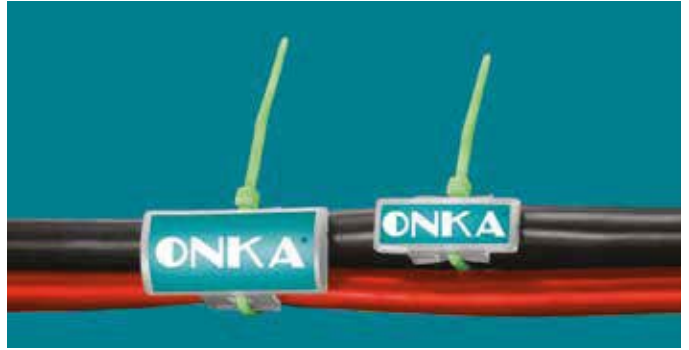

ÜRÜN KODU	EN (mm)	BOY (mm)	CİNSİ	ADET (t)	KUTU ADEDİ
ONKA-8560	33	12	Kablo Bağı Etiket Taşıyıcı		100
ONKA-8561	44	19			100

PANO SİNYAL ve BUTON ETİKETLERİ



ÜRÜN KODU	CİNSİ	ADET (t)	KUTU ADEDİ
İRPSET-3014	PANO SİNYAL ETİKETİ 30x14 mm		100
İRPSET-3015	PANO SİNYAL ETİKETİ 27x12 mm		100
İRPSET-3016	PANO SİNYAL ETİKETİ 27x18 mm		100
İRPSET-3017	PANO SİNYAL ETİKETİ 27x12 mm		100



KABLO RAKORLARI



PG POLYAMİD KABLO RAKORU (IP-68)

ORING



Ral 7035

Ral 7001

Ral 9005

BOY	MONTAJ ÇAPI	RENK (RAL)	YENİ KOD	ESKİ KOD	ADET (t)	YENİ KOD (Oring Contalı)	ESKİ KOD (Oring Contalı)	ADET (t) (Oring Contalı)	KUTU ADEDİ	KOLİ ADEDİ
PG-7	12,5	7035 ▶	1110049	ONKA-9101	2,94	1110065	ONKA-9080	3,39	450	6750
		7001 ▶	1110001	ONKA-9000		1110017	ONKA-9058			
		9005 ▶	1110096	ONKA-9102		1110112	ONKA-9123			
PG-9	15	7035 ▶	1110050	ONKA-9111	3,87	1110066	ONKA-9081	4,13	300	4500
		7001 ▶	1110002	ONKA-9001		1110018	ONKA-9059			
		9005 ▶	1110097	ONKA-9112		1110113	ONKA-9124			
PG-11	18,4	7035 ▶	1110051	ONKA-9121	5,08	1110067	ONKA-9082	5,53	200	3000
		7001 ▶	1110003	ONKA-9002		1110019	ONKA-9060			
		9005 ▶	1110098	ONKA-9122		1110114	ONKA-9125			
PG-13,5	20	7035 ▶	1110052	ONKA-9131	6,32	1110068	ONKA-9083	6,65	175	2625
		7001 ▶	1110004	ONKA-9003		1110020	ONKA-9061			
		9005 ▶	1110099	ONKA-9132		1110115	ONKA-9126			
PG-16	22	7035 ▶	1110053	ONKA-9141	7,30	1110069	ONKA-9084	8,03	125	1875
		7001 ▶	1110005	ONKA-9004		1110021	ONKA-9062			
		9005 ▶	1110100	ONKA-9142		1110116	ONKA-9127			
PG-21	28	7035 ▶	1110054	ONKA-9151	11,03	1110070	ONKA-9085	11,99	75	1125
		7001 ▶	1110006	ONKA-9005		1110022	ONKA-9063			
		9005 ▶	1110101	ONKA-9152		1110117	ONKA-9128			
PG-29	37	7035 ▶	1110055	ONKA-9161	18,36	1110071	ONKA-9086	20,01	40	600
		7001 ▶	1110007	ONKA-9006		1110023	ONKA-9064			
		9005 ▶	1110102	ONKA-9162		1110118	ONKA-9129			
PG-36	47	7035 ▶	1110056	ONKA-9171	35,26	1110072	ONKA-9087	37,82	20	300
		7001 ▶	1110008	ONKA-9007		1110024	ONKA-9065			
		9005 ▶	1110103	ONKA-9172		1110119	ONKA-9130			
PG-42	54	7035 ▶	1110057	ONKA-9181	43,52	1110073	ONKA-9088	46,46	15	225
		7001 ▶	1110009	ONKA-9008		1110025	ONKA-9066			
		9005 ▶	1110104	ONKA-9182		1110120	ONKA-9133			
PG-48	60	7035 ▶	1110058	ONKA-9191	47,72	1110074	ONKA-9089	50,82	12	180
		7001 ▶	1110010	ONKA-9009		1110026	ONKA-9067			
		9005 ▶	1110105	ONKA-9192		1110121	ONKA-9134			

METRİK POLYAMİD KABLO RAKORU (IP-68)

ORING



BOY	MONTAJ ÇAPI	RENK (RAL)	YENİ KOD	ESKİ KOD	ADET (t)	YENİ KOD (Oring Contalı)	ESKİ KOD (Oring Contalı)	ADET (t)	KUTU ADEDİ	KOLİ ADEDİ
M12X1,5	12	7035 ▶	1110059	ONKA-9201	2,86	1110075	ONKA-9113	3,31	450	6750
		7001 ▶	1110011	ONKA-9050		1110027	ONKA-9103			
		9005 ▶	1110106	ONKA-9202		1110122	ONKA-9135			
M16X1,5	16	7035 ▶	1110060	ONKA-9211	5,36	1110076	ONKA-9114	6,07	200	3000
		7001 ▶	1110012	ONKA-9051		1110028	ONKA-9104			
		9005 ▶	1110107	ONKA-9212		1110123	ONKA-9136			
M20X1,5	20	7035 ▶	1110061	ONKA-9221	6,27	1110077	ONKA-9115	6,56	150	2250
		7001 ▶	1110013	ONKA-9052		1110029	ONKA-9105			
		9005 ▶	1110108	ONKA-9222		1110124	ONKA-9137			
M25X1,5	25	7035 ▶	1110062	ONKA-9231	11,85	1110078	ONKA-9116	13,14	75	1125
		7001 ▶	1110014	ONKA-9053		1110030	ONKA-9106			
		9005 ▶	1110109	ONKA-9232		1110125	ONKA-9138			
M32X1,5	32	7035 ▶	1110063	ONKA-9241	18,86	1110079	ONKA-9117	20,59	40	600
		7001 ▶	1110015	ONKA-9054		1110031	ONKA-9107			
		9005 ▶	1110110	ONKA-9242		1110126	ONKA-9139			
M40X1,5	40	7035 ▶	1110064	ONKA-9251	34,16	1110080	ONKA-9118	36,79	20	300
		7001 ▶	1110016	ONKA-9055		1110032	ONKA-9108			
		9005 ▶	1110111	ONKA-9252		1110127	ONKA-9140			

PG SERİ POLYAMİD SOMUN



Ral 7035



Ral 7001



Ral 9005

BOY	MONTAJ ÇAPI	RENK (RAL)	YENİ KOD	ESKİ KOD	ADET (t)	KUTU ADEDİ
PG-7	12,5	7035 →	1110081	ONKA-9401	0,44	250
		7001 →	1110033	ONKA-9070		
		9005 →	1110128	ONKA-9402		
PG-9	15,5	7035 →	1110082	ONKA-9411	0,53	250
		7001 →	1110034	ONKA-9071		
		9005 →	1110129	ONKA-9412		
PG-11	18,5	7035 →	1110083	ONKA-9421	0,66	250
		7001 →	1110035	ONKA-9072		
		9005 →	1110130	ONKA-9422		
PG-13,5	20,5	7035 →	1110084	ONKA-9431	0,85	250
		7001 →	1110036	ONKA-9073		
		9005 →	1110131	ONKA-9432		
PG-16	22,5	7035 →	1110085	ONKA-9441	0,89	250
		7001 →	1110037	ONKA-9074		
		9005 →	1110132	ONKA-9442		
PG-21	28,5	7035 →	1110086	ONKA-9451	1,35	250
		7001 →	1110038	ONKA-9075		
		9005 →	1110133	ONKA-9452		
PG-29	37,5	7035 →	1110087	ONKA-9461	2,24	150
		7001 →	1110039	ONKA-9076		
		9005 →	1110134	ONKA-9462		
PG-36	47,0	7035 →	1110088	ONKA-9471	4,98	100
		7001 →	1110040	ONKA-9077		
		9005 →	1110135	ONKA-9472		
PG-42	55,0	7035 →	1110199	ONKA-2753	5,02	100
		7001 →	1110041	ONKA-9078		
		9005 →	1110200	ONKA-2754		
PG-48	60,0	7035 →	1110089	ONKA-5873	5,94	100
		7001 →	1110042	ONKA-9079		
		9005 →	1110201	ONKA-2755		

METRİK SERİ POLYAMİD SOMUN



Ral 7035



Ral 7001



Ral 9005

BOY	MONTAJ ÇAPI	RENK (RAL)	YENİ KOD	ESKİ KOD	ADET (t)	KUTU ADEDİ
M12X1,5	12	7035 →	1110090	ONKA-9011	0,46	250
		7001 →	1110043	ONKA-9010		
		9005 →	1110136	ONKA-9012		
M16X1,5	16	7035 →	1110091	ONKA-9014	0,51	250
		7001 →	1110044	ONKA-9013		
		9005 →	1110137	ONKA-9015		
M20X1,5	20	7035 →	1110092	ONKA-9017	0,64	250
		7001 →	1110045	ONKA-9016		
		9005 →	1110138	ONKA-9019		
M25X1,5	25	7035 →	1110093	ONKA-9021	1,21	250
		7001 →	1110046	ONKA-9020		
		9005 →	1110139	ONKA-9022		
M32X1,5	32	7035 →	1110094	ONKA-9024	2,33	250
		7001 →	1110047	ONKA-9023		
		9005 →	1110140	ONKA-9025		
M40X1,5	40	7035 →	1110095	ONKA-9027	3,09	250
		7001 →	1110048	ONKA-9026		
		9005 →	1110141	ONKA-9028		

PG SERİ SİRAL KABLO RAKORU (IP-68)



Ral 7035

Ral 7001

Ral 9005

BOY	MONTAJ ÇAPI	RENK (RAL)	YENİ KOD	ESKİ KOD	ADET (t)	KUTU ADEDİ
PG 7	12,5	7035 ▶	1110152	ONKA-9276	4,03	200
		7001 ▶	1110142	ONKA-9275		
		9005 ▶	1110162	ONKA-9277		
PG 11	18,4	7035 ▶	1110154	ONKA-9282	8,66	100
		7001 ▶	1110144	ONKA-9281		
		9005 ▶	1110164	ONKA-9283		
PG 13,5	20	7035 ▶	1110155	ONKA-9285	10,50	80
		7001 ▶	1110145	ONKA-9284		
		9005 ▶	1110165	ONKA-9286		
PG 21	28	7035 ▶	1110157	ONKA-9291	25,62	30
		7001 ▶	1110147	ONKA-9290		
		9005 ▶	1110167	ONKA-9292		

METRİK SERİ SİRAL KABLO RAKORU (IP-68)



Ral 7035

Ral 7001

Ral 9005

BOY	MONTAJ ÇAPI	RENK (RAL)	YENİ KOD	ESKİ KOD	ADET (t)	KUTU ADEDİ
M12 x 1,5	12	7035 ▶	1110158	ONKA-9476	3,95	200
		7001 ▶	1110148	ONKA-9475		
		9005 ▶	1110168	ONKA-9477		
M16 x 1,5	16	7035 ▶	1110159	ONKA-9479	8,64	100
		7001 ▶	1110149	ONKA-9478		
		9005 ▶	1110169	ONKA-9480		
M20 x 1,5	20	7035 ▶	1110160	ONKA-9482	9,95	80
		7001 ▶	1110150	ONKA-9481		
		9005 ▶	1110170	ONKA-9483		
M25 x 1,5	25	7035 ▶	1110161	ONKA-9485	25,87	30
		7001 ▶	1110151	ONKA-9484		
		9005 ▶	1110171	ONKA-9486		

ETANJ PİRİNÇ KABLO RAKOR NİKEL (SOMUNLU) (IP-68)



PG SERİ				UYGUN KABLO ÇAPI (mm)	METRİK SERİ				KUTU ADEDİ
ÜRÜN KODU	BOY	MONTAJ ÇAPI	ADET (t)		ÜRÜN KODU	BOY	MONTAJ ÇAPI	ADET (t)	
REK.06.412	PG-7	12,5	Ⓢ	3 - 6,5	REK.06.012	M12x1,5	12	Ⓢ	50
REK.06.416	PG-9	15,5		4 - 8	REK.06.016	M16x1,5	16		50
REK.06.418	PG-11	19		5 - 10	REK.06.017	M16x1,5	16		50
REK.06.420	PG-13,5	20,5		6 - 12	REK.06.020	M20x1,5	20		50
REK.06.425	PG-16	22,5		10 - 14	REK.06.025	M25x1,5	25		50
REK.06.432	PG-21	28,5		13 - 18	REK.06.032	M32x1,5	32		25
REK.06.440	PG-29	37,5		18 - 25	REK.06.040	M40x1,5	40		20
REK.06.450	PG-36	47		22 - 32	REK.06.050	M50x1,5	50		10
REK.06.456	PG-42	55		30 - 38	REK.06.056	M56x1,5	56		10
REK.06.462	PG-48	60		30 - 38	REK.06.063	M63x1,5	63		10

PLASTİK SİRALLER (SİYAH)



ÜRÜN KODU	ÇAP	ADET (t)	METRE
M-020 400014 00 11	Ø 14	Ⓛ	100
M-020 400016 00 11	Ø 16		100
M-020 400018 00 11	Ø 18		50
M-020 400020 00 11	Ø 20		50
M-020 400026 00 11	Ø 26		50
M-020 400032 00 11	Ø 32		50
M-020 400040 00 11	Ø 40		25
M-020 400050 00 11	Ø 50		25

POLYAMİD (PA6) SİRAL BORU

POLİPROPİLEN (pp) SİRAL BORU



ÖLÇÜ (PA6)	ÖLÇÜ (PP)	RENK	İÇ ÇAP (mm)	DIŞ ÇAP (mm)	ADET (t)	METRE
PA7	PP7	Gri - Siyah	6,5	10,0	Ⓛ	100
PA8,5	PP8,5	Gri - Siyah	8,5	12,0		100
PA10	PP10	Gri - Siyah	10,0	13,0		100
PA12	PP12	Gri - Siyah	12,0	16,0		50
PA14	PA14	Gri - Siyah	14,0	18,5		50
PA17	PP17	Gri - Siyah	17,0	21,5		50
PA19	PP19	Gri - Siyah	19,0	24,0		50
PA22	PP22	Gri - Siyah	22,0	27,5		50
PA23	PP23	Gri - Siyah	23,0	28,7		50
PA26	PP26	Gri - Siyah	26,0	31,0		25
PA29	PP29	Gri - Siyah	29,0	34,5		25
PA36	PP36	Gri - Siyah	36,0	42,5		25
PA48	PP48	Gri - Siyah	48,0	54,5		25

*Siparişlerinizde Polyamid (PA6) veya Polipropilen (pp) taleplerinizi belirtiniz.

POLYAMİD (PA6) SİRAL BORU RAKORU (Somunlu)

GEÇMELİ TİP POLYAMİD SİRAL BORU RAKORU PG



ÖLÇÜ	RENK	UYGUN SİRAL	ADET (t)	KUTU ADEDİ
PG7	Gri - Siyah	PA8,5	Ⓛ	50
PG9	Gri - Siyah	PA10		50
PG11	Gri - Siyah	PA12		50
PG13,5	Gri - Siyah	PA14		50
PG16	Gri - Siyah	PA17		50
PG21	Gri - Siyah	PA23		25
PG29	Gri - Siyah	PA29		20
M16x1,5	Gri - Siyah	PA12		50
M20x1,5	Gri - Siyah	PA17		50
M25x1,5	Gri - Siyah	PA23		25
M32x1,5	Gri - Siyah	PA29		20



ÖLÇÜ	RENK	UYGUN SİRAL	ADET (t)	KUTU ADEDİ
PG7	Gri - Siyah	PA8,5	Ⓛ	100
PG9	Gri - Siyah	PA10		50
PG11	Gri - Siyah	PA12		50
PG13,5	Gri - Siyah	PA14		50
PG16	Gri - Siyah	PA17		50
PG21	Gri - Siyah	PA23		25
PG29	Gri - Siyah	PA29		25
PG36	Gri - Siyah	PA36		10
PG48	Gri - Siyah	PA48		10

*Siparişlerinizde geçmeli veya somunlu taleplerinizi belirtiniz.

GAMAK TİPİ ORJİNAL CAM ELYAFLI MOTOR KLEMENSİ



ÜRÜN KODU	RENK	TİP	BOY (mm)	EN (mm)	VİDA	ADET (t)	KUTU ADEDİ
OR - MKE 01	Kahverengi	56 - 63	40	25	M4	Ⓛ	50
OR - MKE 02		71 - 80 - 90 - 100	50	30	M4		50
OR - MKE 03		132	60	37	M5		50
OR - MKE 04		160 - 180	72	44	M6		40
OR - MKE 05		225 - 250	91	56	M8		16
OR - MKE 06		280	115	70	M10		8

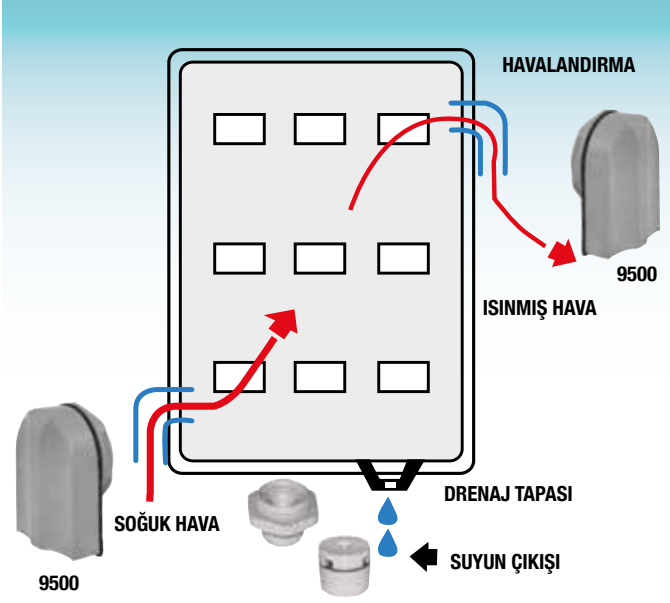

PG POLYAMİD KÖRTAPA



BOY	MONTAJ ÇAP	RENK (RAL)	YENİ KOD	ESKİ KOD	ADET (t)	KUTU ADEDİ
PG-7	12,5	7035 →	1110178	ONKA-9301	1	250
		7001 →	1110172	ONKA-9090		
		9005 →	1110184	ONKA-9302		
PG-9	15,5	7035 →	1110179	ONKA-9311	1	250
		7001 →	1110173	ONKA-9091		
		9005 →	1110185	ONKA-9312		
PG-11	18,5	7035 →	1110180	ONKA-9321	1,38	250
		7001 →	1110174	ONKA-9092		
		9005 →	1110186	ONKA-9322		
PG-13,5	20,5	7035 →	1110181	ONKA-9331	1,72	250
		7001 →	1110175	ONKA-9093		
		9005 →	1110187	ONKA-9332		
PG-16	22,5	7035 →	1110182	ONKA-9341	2,04	250
		7001 →	1110176	ONKA-9094		
		9005 →	1110188	ONKA-9342		
PG-21	28,5	7035 →	1110183	ONKA-9351	2,13	250
		7001 →	1110177	ONKA-9095		
		9005 →	1110189	ONKA-9352		
PG-29	37,5	7035 →			1	150
		7001 →		ONKA-9096		
		9005 →				
PG-36	47,5	7035 →			1	100
		7001 →		ONKA-9097		
		9005 →				

M40 x 1.5 PANO HAVALANDIRMA APARATI

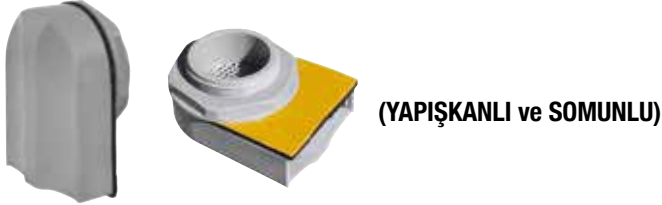

BOY	RENK (RAL)	YENİ KOD	ESKİ KOD	ADET (t)	KUTU ADEDİ
M40 x 1,5	7035 →	1110191	ONKA-9501	23,44	50
	7001 →	1110190	ONKA-9500		
	9005 →	1110192	ONKA-9502		

M25 x 1.5 DRENAJ TAPASI



BOY	RENK (RAL)	YENİ KOD	ESKİ KOD	ADET (t)	KUTU ADEDİ
M25 x 1,5	7035 →	1110194	ONKA-9511	3,91	100
	7001 →	1110193	ONKA-9510		
	9005 →	1110195	ONKA-9512		

Ø16 DRENAJ TAPASI



BOY	RENK (RAL)	YENİ KOD	ESKİ KOD	ADET (t)	KUTU ADEDİ
Ø 16	7035 →	1110197	ONKA-9521	4,34	100
	7001 →	1110196	ONKA-9520		
	9005 →	1110198	ONKA-9522		

KAUÇUK KÖRTAPA



ÜRÜN KODU	BOY	MONTAJ ÇAP	ADET (t)	KUTU ADEDİ
ONKA-9490	PG-13.5	17	1	100
ONKA-9491	PG-16	22.8		100
ONKA-9492	PG-21	28.6		100
ONKA-9493	PG-29	37.3		100
ONKA-9494	PG-36	47		100
ONKA-9495	PG-42	55		50

RAYA MONTAJ KAPAKLI PANO PRİZİ



PİRİNÇ METAL AĞIRLIK
GR 14,20 GR



METAL MANDAL

RAYA MONTAJ KAPAKLI PANO PRİZİ (16 A / 250 V)



ÜRÜN KODU	AÇIKLAMA	ADET (t)	KUTU/KOLİ
ONKA - 7160	Tek Girişli LED'siz Topraklı	88,00	10 /120
ONKA - 7161	Çift Girişli LED'siz Topraklı	110,50	
ONKA - 7162	Tek Girişli LED'li Topraklı	112,00	
ONKA - 7163	Çift Girişli LED'li Topraklı	131,25	
ONKA - 7164	Tek Girişli LED'siz UPS'li	86,40	
ONKA - 7165	Çift Girişli LED'siz UPS'li	124,80	
ONKA - 7166	Tek Girişli LED'li UPS'li	108,80	
ONKA - 7167	Çift Girişli LED'li UPS'li	140,80	

KABLO KANALLARI (DELİKLİ)

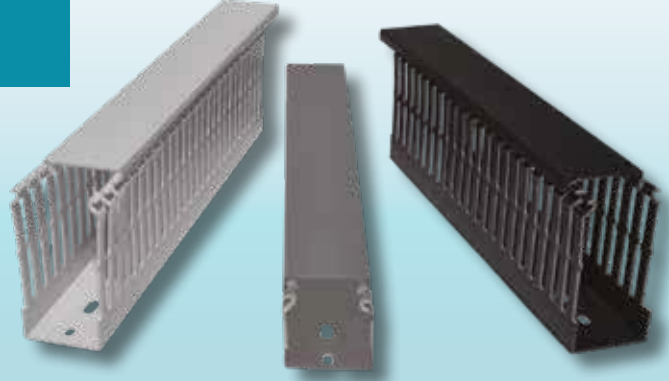

PANO İÇİ DELİKLİ KABLO KANALI



EBAT (Genişlik x Derinlik)	YENİ KOD	ESKİ KOD	METRE (t)	HALOJEN FREE YENİ KOD	HALOJEN FREE ESKİ KOD	HALOJEN FREE METRE (t)	KUTU METRE
25 x 30 mm	1120001	ONKA-7180	Ⓢ	1120013	ONKA-7310	Ⓢ	84
25 x 40 mm	1120002	ONKA-7181		1120014	ONKA-7311		84
25 x 60 mm	1120003	ONKA-7182		1120015	ONKA-7312		48
40 x 40 mm	1120004	ONKA-7183		1120016	ONKA-7313		60
40 x 60 mm	1120005	ONKA-7184		1120017	ONKA-7314		36
40 x 80 mm	1120006	ONKA-7186		1120018	ONKA-7315		40
60 x 40 mm	1120007	ONKA-7177		1120019	ONKA-7316		40
60 x 60 mm	1120008	ONKA-7185		1120020	ONKA-7317		24
60 x 80 mm	1120009	ONKA-7188		1120021	ONKA-7318		24
80 x 60 mm	1120010	ONKA-7187		1120022	ONKA-7319		24
80 x 80 mm	1120011	ONKA-7178		1120023	ONKA-7320		24
100 X 60 mm	1120012	ONKA-7179		1120024	ONKA-7321		24

PANO İÇİ DELİKLİ KABLO KANALI (YAPIŞKANLI)



EBAT (Genişlik x Derinlik)	YENİ KOD	ESKİ KOD	METRE (t)	HALOJEN FREE YENİ KOD	HALOJEN FREE ESKİ KOD	HALOJEN FREE METRE (t)	KUTU METRE
25 x 30 mm	1120025	ONKA-7220	Ⓢ	1120037	ONKA-7380	Ⓢ	84
25 x 40 mm	1120026	ONKA-7221		1120038	ONKA-7381		84
25 x 60 mm	1120027	ONKA-7222		1120039	ONKA-7382		48
40 x 40 mm	1120028	ONKA-7223		1120040	ONKA-7383		60
40 x 60 mm	1120029	ONKA-7224		1120041	ONKA-7384		36
40 x 80 mm	1120030	ONKA-7225		1120042	ONKA-7385		40
60 x 40 mm	1120031	ONKA-7226		1120043	ONKA-7386		40
60 x 60 mm	1120032	ONKA-7227		1120044	ONKA-7387		24
60 x 80 mm	1120033	ONKA-7228		1120045	ONKA-7388		24
80 x 60 mm	1120034	ONKA-7229		1120046	ONKA-7389		24
80 x 80 mm	1120035	ONKA-7230		1120047	ONKA-7390		24
100 X 60 mm	1120036	ONKA-7231		1120048	ONKA-7391		24

Onka®

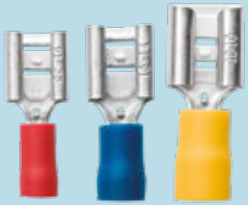
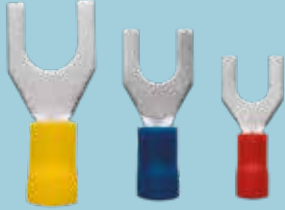

KABLO UÇLARI

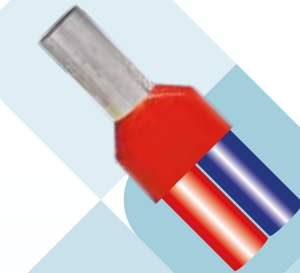

KUTULU SERİ İZOLELİ TEK GİRİŞLİ KABLO YÜKSÜKLERİ DIN 46228 (-40 °C / 105 °C)

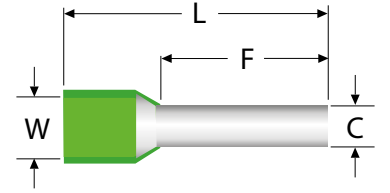

RENK NORMLARI		
FRANSIZ	ALMAN	DIN

	ÜRÜN KODU	KABLO KESİTİ (mm²)	F	L	C	W	ADET (t)	KUTU ADEDİ
ST	ONKA-8005	0,34	8,0	12,0	0,80	1,9		1.000
	ONKA-8006	0,50	6,0	12,0	1,00	2,6		1.000
ST	ONKA-8007	0,50	8,0	14,0	1,00	2,6		1.000
	ONKA-8008	0,50	10,0	16,0	1,00	2,6		1.000
	ONKA-8009	0,75	6,0	12,0	1,20	2,8		1.000
ST	ONKA-8010	0,75	8,0	14,0	1,20	2,8		1.000
	ONKA-8011	0,75	10,0	16,0	1,20	2,8		1.000
	ONKA-8012	0,75	12,0	18,0	1,20	2,8		1.000
	ONKA-8013	1,00	6,0	12,0	1,40	3,0		1.000
ST	ONKA-8014	1,00	8,0	14,0	1,40	3,0		1.000
	ONKA-8015	1,00	10,0	16,0	1,40	3,0		1.000
	ONKA-8016	1,00	12,0	18,0	1,40	3,0		1.000
ST	ONKA-8017	1,50	8,0	14,0	1,70	3,5		500
	ONKA-8018	1,50	10,0	16,0	1,70	3,5		500
	ONKA-8019	1,50	12,0	18,0	1,70	3,5		500
	ONKA-8020	1,50	18,0	24,0	1,70	3,5		500
ST	ONKA-8021	2,50	8,0	14,0	2,20	4,2		500
	ONKA-8022	2,50	10,0	16,0	2,20	4,2		500
	ONKA-8023	2,50	12,0	18,0	2,20	4,2		500
	ONKA-8024	2,50	18,0	24,0	2,20	4,2		500
ST	ONKA-8025	4,00	10,0	17,0	2,80	4,8		200
	ONKA-8026	4,00	12,0	20,0	2,80	4,8		200
	ONKA-8027	4,00	18,0	26,0	2,80	4,8		200
ST	ONKA-8028	6,00	12,0	20,0	3,50	6,3		200
	ONKA-8029	6,00	18,0	26,0	3,50	6,3		200
ST	ONKA-8030	10	12,0	22,0	4,50	7,6		100
	ONKA-8031	10	18,0	28,0	4,50	7,6		100
ST	ONKA-8032	16	12,0	24,0	5,80	8,8		100
	ONKA-8033	16	18,0	28,0	5,80	8,8		75
ST	ONKA-8034	25	16,0	30,0	7,30	11,2		50
	ONKA-8156	25	18,0	32,0	7,30	11,2		50
	ONKA-8035	25	22,0	36,0	7,30	11,2		50
ST	ONKA-8036	35	16,0	30,0	8,30	12,7		50
	ONKA-8037	35	18,0	32,0	8,30	12,7		25
	ONKA-8038	35	25,0	39,0	8,30	12,7		25
ST	ONKA-8039	50	20,0	36,0	10,30	15,0		25
	ONKA-8040	50	25,0	40,0	10,30	15,0		25
ST	ONKA-8041	70	21,0	37,0	13,50	16,0		10
ST	ONKA-8042	95	25,0	44,0	14,70	18,0		10
ST	ONKA-8043	120	27,0	48,0	16,70	20,0		10
ST	ONKA-8044	150	32,0	58,0	19,50	23,0		10

KUTULU SERİ İZOLELİ ÇİFT GİRİŞLİ KABLO YÜKSÜKLERİ DIN 46228

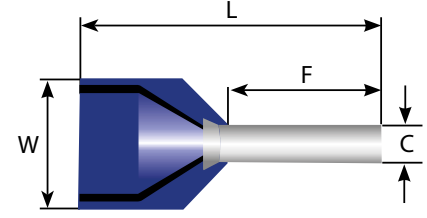

- DIN 46228 Standardı,
- Bakır Malzemeden Kalay Kaplı,
- Polyamid İzoleli,
- -40 °C / + 105 °C Çalışma Sıcaklığı

RENK NORMLARI		
FRANSIZ	ALMAN	DIN

ÜRÜN KODU	KABLO KESİTİ (mm ²)	F	L	C	W	ADET (t)	KUTU ADEDİ
ST ONKA-8161	2 x 0,50	8,0	15,0	1,5	2,5 / 4,7	☎	500
ST ONKA-8162	2 x 0,75	0,8	15,0	1,8	2,8 / 5,0		500
ONKA-8163	2 x 0,75	10,0	17,0	1,8	2,8 / 5,0		500
ST ONKA-8164	2 x 1,0	8,0	15,0	2,05	3,4 / 5,4		500
ONKA-8165	2 x 1,0	10,0	17,0	2,05	3,4 / 5,4		500
ST ONKA-8166	2 x 1,5	8,0	16,0	2,3	3,6 / 6,6		500
ONKA-8528	2 x 1,5	10,0	16,0	2,3	3,6 / 6,6		500
ONKA-8167	2 x 1,5	12,0	20,0	2,3	3,6 / 6,6		500
ST ONKA-8168	2 x 2,5	10,0	18,5	2,8	4,2 / 7,8		250
ONKA-8169	2 x 2,5	13,0	21,5	2,8	4,2 / 7,8		250
ST ONKA-8170	2 x 4,0	12,0	23,0	3,7	4,9 / 8,8		100
ST ONKA-8171	2 x 6,0	14,0	26,0	4,8	6,9 / 10,0		100
ST ONKA-8172	2 x 10,0	14,0	26,5	6,4	7,6 / 12,8		50
ST ONKA-8173	2 x 16,0	14,0	31,5	8,3	9,6 / 18,6		50

KUTULU SERİ İZOLESİZ KABLO YÜKSÜKLERİ DIN 46228

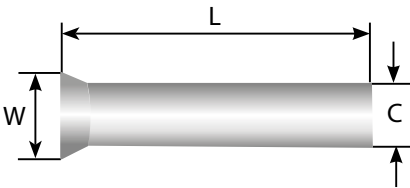

ÜRÜN KODU	KABLO KESİTİ (mm ²)	L	C	W	ADET (t)	KUTU ADEDİ
ONKA - 8100	0.50	6.0	1.0	2.1	☎	1.000
ONKA - 8101	0.50	8.0	1.0	2.1		1.000
ONKA - 8102	0.50	10.0	1.0	2.1		1.000
ONKA - 8103	0.75	6.0	1.2	2.3		1.000
ONKA - 8104	0.75	8.0	1.2	2.3		1.000
ONKA - 8105	0.75	10.0	1.2	2.3		1.000
ONKA - 8107	1.0	8.0	1.4	2.5		1.000
ONKA - 8108	1.0	10.0	1.4	2.5		1.000
ONKA - 8109	1.0	12.0	1.4	2.5		1.000
ONKA - 8111	1.5	8.0	1.7	2.8		1.000
ONKA - 8112	1.5	10.0	1.7	2.8		1.000
ONKA - 8113	1.5	12.0	1.7	2.8		1.000
ONKA - 8115	2.5	8.0	2.2	3.4		1.000
ONKA - 8116	2.5	10.0	2.2	3.4		1.000
ONKA - 8117	2.5	12.0	2.2	3.4		1.000
ONKA - 8118	4.0	8.0	2.8	4.0		1000
ONKA - 8120	4.0	10.0	2.8	4.0		1000
ONKA - 8121	4.0	12.0	2.8	4.0		1000
ONKA - 8122	4.0	15.0	2.8	4.0		1000
ONKA - 8123	4.0	18.0	2.8	4.0		1000
ONKA - 8124	6.0	10.0	3.5	4.7		500
ONKA - 8125	6.0	12.0	3.5	4.7		500
ONKA - 8126	6.0	15.0	3.5	4.7		500
ONKA - 8127	6.0	18.0	3.5	4.7		500
ONKA - 8128	10.0	12.0	4.5	5.8		200
ONKA - 8129	10.0	15.0	4.5	5.8		200
ONKA - 8130	10.0	18.0	4.5	5.8		200
ONKA - 8131	16.0	12.0	5.8	7.5		100
ONKA - 8132	16.0	15.0	5.8	7.5		100
ONKA - 8133	16.0	18.0	5.8	7.5		100
ONKA - 8134	25.0	15.0	7.3	9.5		100
ONKA - 8135	25.0	16.0	7.3	9.5		100
ONKA - 8136	25.0	18.0	7.3	9.5		100
ONKA - 8137	25.0	22.0	7.3	9.5	100	
ONKA - 8138	35.0	16.0	8.3	11.0	75	
ONKA - 8139	35.0	18.0	8.3	11.0	75	
ONKA - 8140	35.0	20.0	8.3	11.0	75	
ONKA - 8141	35.0	25.0	8.3	11.0	75	
ONKA - 8142	50.0	18.0	10.3	13.0	25	
ONKA - 8143	50.0	20.0	10.3	13.0	25	
ONKA - 8144	50.0	25.0	10.3	13.0	25	
ONKA - 8146	70.0	25.0	13.5	15.3	10	
ONKA - 8148	95.0	25.0	14.7	16.6	10	
ONKA - 8151	120.0	32.0	16.7	18.0	10	
ONKA - 8153	150.0	32.0	19.5	21.5	10	

DIN 46228 Standardı,
Bakır Malzemedden Kalay Kaplı

İZOLELİ YUVARLAK KABLO UÇLARI

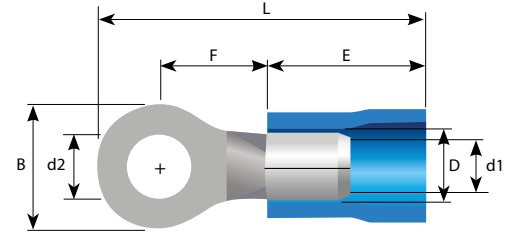

DIN 46237 Standardı, Bakır Malzemeden Kalay Kaplı, PVC İzoleli, 105 °C Çalışma Sıcaklığı, 600 Volt Çalışma Gerilimi

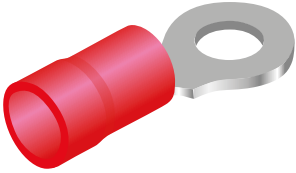

0,5 ~ 1,5 mm², Kablo Kesiti

ÜRÜN KODU	METRİK ÖLÇÜ (d2)	B	L	F	E	D	d1	ADET (t)	KUTU ADEDİ
ONKA-8045 -R1-3 V	3.2	5.5	16.7	4.0	10.0	4.1	1.7	⚡	200
ONKA-8047-R1-3.5 MV	3.7	6.6	19.6	6.3	10.0	4.1	1.7		200
ONKA-8049-R1-4 SV	4.3	6.6	19.6	6.3	10.0	4.1	1.7		200
ONKA-8050-R1-4 LV	4.3	8.0	21.0	7.0	10.0	4.1	1.7		200
ONKA-8051-R1-5 V	5.3	8.0	21.0	7.0	10.0	4.1	1.7		200
ONKA-8052-R1-6 V	6.5	11.6	26.8	11.1	10.0	4.1	1.7		200
ONKA-8053-R1-8 V	8.4	11.6	26.8	11.1	10.0	4.1	1.7		200
ONKA-8054-R1-10 V	10.5	13.6	30.7	13.9	10.0	4.1	1.7		100
ONKA-8055-R1-12 V	13	19.2	35.6	16.0	10.0	4.1	1.7		100

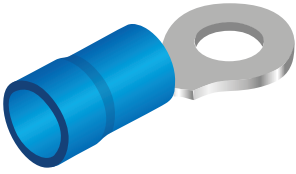

1,5 ~ 2,5 mm², Kablo Kesiti

ONKA-8056-R2-3 V	3.2	6.4	17.5	4.3	10.0	4.5	2.3	⚡	200
ONKA-8058-R2-3.5 MV	3.7	6.6	19.5	6.3	10.0	4.5	2.3		200
ONKA-8059-R2-3.5 LV	3.7	8.5	22.0	7.8	10.0	4.5	2.3		200
ONKA-8060-R2-4 SV	4.3	6.6	19.5	6.3	10.0	4.5	2.3		200
ONKA-8086-R2-4 LV	4.3	8.5	22.0	7.8	10.0	4.5	2.3		200
ONKA-8087-R2-5 SV	5.3	8.5	22.0	7.8	10.0	4.5	2.3		200
ONKA-8088-R2-5 LV	5.3	9.5	22.0	7.3	10.0	4.5	2.3		200
ONKA-8089-R2-6 V	6.5	12.0	27.0	11.0	10.0	4.5	2.3		200
ONKA-8090-R2-8 V	8.4	12.0	27.0	11.0	10.0	4.5	2.3		200
ONKA-8091-R2-10 V	10.5	13.6	30.7	13.9	10.0	4.5	2.3		100
ONKA-8092-R2-12 V	13.0	19.2	35.6	16.0	10.0	4.5	2.3		100

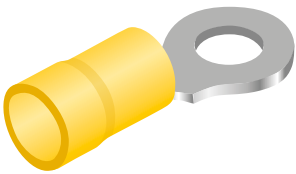

4,0 ~ 6,0 mm², Kablo Kesiti

ONKA-8093-R5-4 SV	4.3	7.2	22.0	5.9	12.5	6.5	3.4	⚡	75
ONKA-8094-R5-4 LV	4.3	9.5	25.5	8.3	12.5	6.5	3.4		75
ONKA-8095-R5-5 V	5.3	9.5	25.5	8.3	12.5	6.5	3.4		75
ONKA-8096-R5-6 V	6.5	12.0	29.0	10.5	12.5	6.5	3.4		75
ONKA-8097-R5-8 V	8.4	15.0	33.7	13.7	12.5	6.5	3.4		75
ONKA-8098-R5-10 V	10.5	15.0	33.7	13.7	12.5	6.5	3.4		75
ONKA-8099-R5-12 V	13.0	19.2	38.1	16.0	12.5	6.5	3.4		75

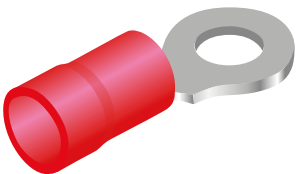

8.0 ~ 10.0 mm², Kablo Kesiti

ONKA-8158-R8-4 LV	4.3	12.0	32.5	9.7	17.0	8.0	4.5	⚡	50
ONKA-8159-R8-5 MV	5.3	12.0	32.5	9.7	17.0	8.0	4.5		50
ONKA-8160-R8-6 SV	6.7	12.0	32.5	9.7	17.0	8.0	4.5		50
ONKA-8174-R8-5 LV	5.3	15.0	38.0	13.8	17.0	8.0	4.5		50
ONKA-8175-R8-6 LV	6.7	15.0	38.0	13.8	17.0	8.0	4.5		50
ONKA-8176-R8-8 V	8.4	15.0	38.0	13.8	17.0	8.0	4.5		50
ONKA-8177-R8-10 V	10.5	15.0	38.0	13.8	17.0	8.0	4.5		50

İZOLELİ ÇATAL TİP KABLO UÇLARI

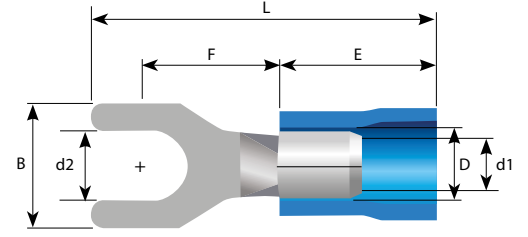

DIN 46237 Standardı, Bakır Malzemeden Kalay Kaplı, PVC İzoleli, 105 °C Çalışma Sıcaklığı, 600 Volt Çalışma Gerilimi

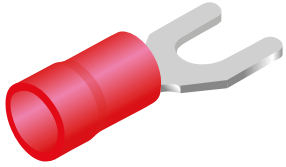

0,5 ~ 1,5 mm² , Kablo Kesiti

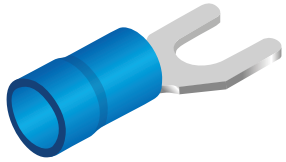

1,5 ~ 2,5 mm² , Kablo Kesiti

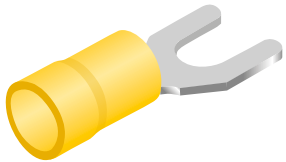

4,0 ~ 6,0 mm² , Kablo Kesiti

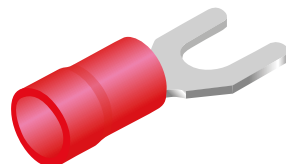

8,0 ~ 10,0 mm² , Kablo Kesiti

ÜRÜN KODU	METRİK ÖLÇÜ (d2)	B	L	F	E	D	d1	ADET (t)	KUTU ADEDİ
ONKA - 8061-3 V	3.2	5.8	21.0	6.3	10.0	4.1	1.7	⚡	200
ONKA - 8062-3.5 SV	3.7	6.4	20.6	6.3	10.0	4.1	1.7		200
ONKA - 8063-3.5 LV	3.7	7.2	21.0	6.3	10.0	4.1	1.7		200
ONKA - 8064-4 SV	4.3	6.4	20.6	6.3	10.0	4.1	1.7		200
ONKA - 8065-4 MV	4.3	7.2	21.0	6.3	10.0	4.1	1.7		200
ONKA - 8066-5 SV	5.3	8.0	21.0	7.0	10.0	4.1	1.7		200
ONKA - 8067-5 LV	5.3	9.5	21.0	7.0	10.0	4.1	1.7		200
ONKA - 8068-6 LV	6.5	12.0	27.2	11.0	10.0	4.1	1.7		200
ONKA - 8069-8 V	8.4	12.0	27.2	11.0	10.0	4.1	1.7		100

ONKA - 8070-3 V	3.2	5.8	21.0	6.3	10.0	4.5	2.3	⚡	200
ONKA - 8071-3.5 MV	3.7	6.4	21.0	6.3	10.0	4.5	2.3		200
ONKA - 8072-4 SV	4.3	6.4	21.0	6.3	10.0	4.5	2.3		200
ONKA - 8073-4 MV	4.3	7.2	21.2	6.5	10.0	4.5	2.3		200
ONKA - 8074-5 LV	5.3	9.5	22.0	7.2	10.0	4.5	2.3		200
ONKA - 8075-6 LV	6.5	12.0	27.2	11.0	10.0	4.5	2.3		200
ONKA - 8076-8 V	8.4	12.0	27.2	11.0	10.0	4.5	2.3		100

ONKA - 8580 -3.5 SV	3.7	7.2	25.2	7.5	12.5	6.5	3.4	⚡	75
ONKA - 8077-4 SV	4.3	8.5	25.2	7.5	12.5	6.5	3.4		75
ONKA - 8078-4 LV	4.3	9.5	25.2	7.5	12.5	6.5	3.4		75
ONKA - 8079-5 V	5.3	9.5	25.2	7.5	12.5	6.5	3.4		75
ONKA - 8080-6 SV	6.5	9.5	25.2	7.5	12.5	6.5	3.4		75
ONKA - 8081-6 LV	6.5	12.0	31.2	12.0	12.5	6.5	3.4		75
ONKA - 8082-8V	8.4	13.5	30.0	10.5	12.5	6.5	3.4		75

ONKA - 8083-4V	4.3	8.2	29.0	8.1	17.0	8.0	4.5	⚡	50
ONKA - 8084-5V	5.3	9.0	29.0	8.1	17.0	8.0	4.5		50
ONKA - 8085-6V	6.5	10.8	30.5	8.6	17.0	8.0	4.5		50

S: Small

M: Medium

L: Large

PVC İZOLELİ FASTON DİŞİ KABLO UCU



Pirinç Malzemededen Kalay Kaplı,
PVC İzoleli,
75 °C Çalışma Sıcaklığı,
300 Volt Çalışma Gerilimi

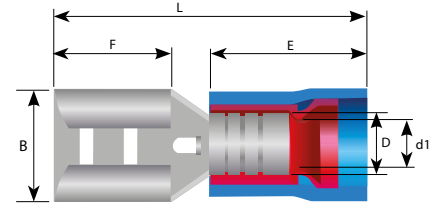

EXTRA ÇİFT YÜKSÜKLÜ

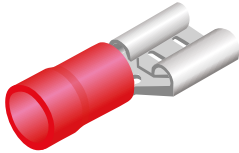

0,5 ~ 1,5 mm², Kablo Kesiti

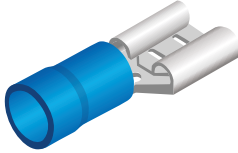

1,5 ~ 2,5 mm², Kablo Kesiti

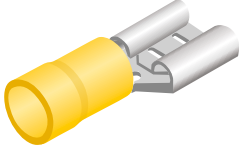

4,0 ~ 6,0 mm², Kablo Kesiti

ÜRÜN KODU	SOKET GENİŞLİĞİ	B	F	L	E	D	d1	ADET (t)	KUTU ADEDİ
ONKA - 8230-F1-2.8 VD/5	0.5 x 2.8	3.2	6.4	18.5	10.0	4.3	1.7	⚡	200
ONKA - 8231-F1-2.8 VD/8	0.8 x 2.8	3.2	6.4	18.5	10.0	4.3	1.7		200
ONKA - 8232-F1-4.8 VD/5	0.5 x 4.8	5.0	6.5	19.0	10.0	4.3	1.7		200
ONKA - 8233-F1-4.8 VD/8	0.8 x 4.8	5.0	6.5	19.0	10.0	4.3	1.7		200
ONKA - 8234-F1-6.4 VD	0.8 x 6.4	6.6	7.9	21.0	10.0	4.3	1.7		200
ONKA - 8235-F1-8 VD	0.8 x 8.0	8.4	10.0	24.0	10.0	4.3	1.7		200
ONKA - 8236-F2-2.8 VD/5	0.5 x 2.8	3.2	6.4	18.5	10.0	5.0	2.3	⚡	150
ONKA - 8237-F2-2.8 VD/8	0.8 x 2.8	3.2	6.4	18.5	10.0	5.0	2.3		150
ONKA - 8238-F2-4.8 VD/5	0.5 x 4.8	5.0	6.5	19.0	10.0	5.0	2.3		150
ONKA - 8239-F2-4.8 VD/8	0.8 x 4.8	5.0	6.5	19.0	10.0	5.0	2.3		150
ONKA - 8240-F2-6.4 VD	0.8 x 6.4	6.6	7.9	21.0	10.0	5.0	2.3		150
ONKA - 8241-F2-8 VD	0.8 x 8.0	8.4	10.0	24.0	10.0	5.0	2.3		150
ONKA - 8242-F2-9.5 VD	1.2 x 9.5	9.5	12.5	29.0	10.0	5.0	2.3	150	
ONKA - 8243-F5-6.4 VD	0.8 x 6.4	6.6	7.9	23.5	12.5	6.5	3.4	⚡	100
ONKA - 8244-F5-9.5VD	1.2 x 9.5	9.9	12.5	28.5	12.5	6.5	3.4		100

İZOLELİ EKSTRA ÇİFT YÜKSÜKLÜ ERKEK KABLO UCU



Pirinç malzemededen kalay kaplı,
PVC izoleli,
75 °C çalışma sıcaklığı,
300 Volt Çalışma Gerilimi

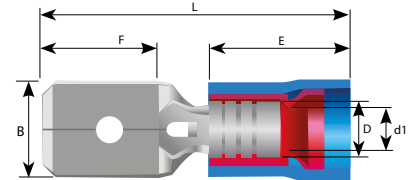

ÜRÜN KODU	KABLO KESİTİ (mm ²)	SOKET GENİŞLİĞİ	ÖLÇÜLER (mm)						ADET (t)	KUTU ADEDİ
			B	F	L	E	D	d1		
ONKA-8264-M1 - 2.8 VD/5	0.5~1.5 mm 22~16 AWG	0.5 x 2.8	2.8	7.0	19.2	10.0	4.3	1.7	⚡	200
ONKA-8265-M1 - 2.8 VD/8		0.8 x 2.8	2.8	7.8	20.5					200
ONKA-8266-M1 - 4.8 VD/5		0.5 x 4.8	4.8	7.0	19.2					200
ONKA-8267-M1 - 4.8 VD/8		0.8 x 4.8	4.8	7.8	20.5					200
ONKA-8268-M1 - 6.4 VD		0.8 x 6.4	6.4	7.8	21.2					200
ONKA-8269-M2 - 2.8 VD/5	1.5~2.5 mm 16~14 AWG	0.5 x 2.8	2.8	7.0	19.2	10.0	5.0	2.3	⚡	200
ONKA-8270-M2 - 2.8 VD/8		0.8 x 2.8	2.8	7.8	20.5					200
ONKA-8271-M2 - 4.8 VD/5		0.5 x 4.8	4.8	7.0	19.2					200
ONKA-8272-M2 - 4.8 VD/8		0.8 x 4.8	4.8	7.8	20.5					200
ONKA-8273-M2 - 6.4 VD		0.8 x 6.4	6.4	7.8	21.2					200
ONKA-8274-M5 - 6.4 VD	4.0~6.0 mm 12~10 AWG	0.8 x 6.4	6.4	7.8	23.7	12.5	6.5	3.4	⚡	100

PVC FULL İZOLELİ FASTON DİŞİ KABLO UCU



Pirinç Malzemeden Kalay Kaplı,
PVC İzoleli,
75 °C Çalışma Sıcaklığı,
300 Volt Çalışma Gerilimi

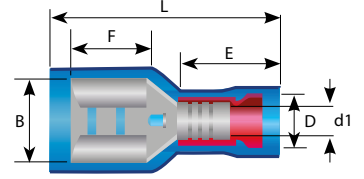

EXTRA ÇİFT YÜKSÜKLÜ



0,5 ~ 1,5 mm², Kablo Kesiti

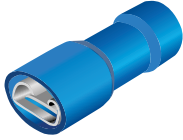

1,5 ~ 2,5 mm², Kablo Kesiti

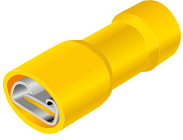

4,0 ~ 6,0 mm², Kablo Kesiti

ÜRÜN KODU	SOKET GENİŞLİĞİ	B	F	L	E	D	d1	ADET (t)	KUTU ADEDİ
ONKA - 8250-F1-2.8 VFD-5	0.5 x 2.8	3.2	6.4	19.0	10.0	4.3	1.7	⚡	200
ONKA - 8251-F1-2.8 VFD-8	0.8 x 2.8	3.2	6.4	19.0	10.0	4.3	1.7		200
ONKA - 8252-F1-4.8 VFD-5	0.5 x 4.8	5.0	6.5	20.0	10.0	4.3	1.7		200
ONKA - 8253-F1-4.8 VFD-8	0.8 x 4.8	5.0	6.5	20.0	10.0	4.3	1.7		200
ONKA - 8254-F1-6.4 VFD	0.8 x 6.4	6.6	7.9	22.0	10.0	4.3	1.7		100

ONKA - 8255-F2-2.8 VFD-5	0.5 x 2.8	3.2	6.4	19.0	10.0	5.0	2.3	⚡	100
ONKA - 8256-F2-2.8 VFD-8	0.8 x 2.8	3.2	6.4	19.0	10.0	5.0	2.3		100
ONKA - 8257-F2-4.8 VFD-5	0.5 x 4.8	5.0	6.5	20.0	10.0	5.0	2.3		100
ONKA - 8258-F2-4.8 VFD-8	0.8 x 4.8	5.0	6.5	20.0	10.0	5.0	2.3		100
ONKA - 8259-F2-6.4 VFD	0.8 x 6.4	6.6	7.9	22.0	10.0	5.0	2.3		100

ONKA - 8260-F5-6.4 VFD	0.8 x 6.4	6.6	7.9	25.0	13.0	6.5	3.4	⚡	75
------------------------	-----------	-----	-----	------	------	-----	-----	---	----

POLYAMİD FULL İZOLELİ DİŞİ FASTON KABLO UCU

Pirinç malzemeden kalay kaplı,
polyamid izoleli,
105 °C çalışma sıcaklığı,
300 Volt Çalışma Gerilimi

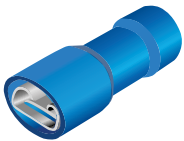
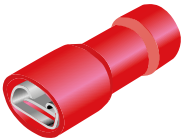
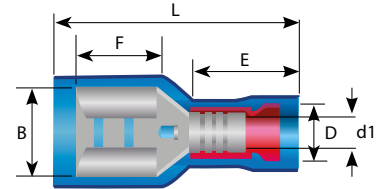

ÜRÜN KODU	KABLO KESİTİ (mm ²)	SOKET GENİŞLİĞİ	ÖLÇÜLER (mm)						ADET (t)	KUTU ADEDİ
			B	F	L	E	D	d1		
ONKA - 8529- F1 - 2.8 AFC	0.5 ~ 1.5 mm 22 ~ 16 AWG	0.8 x 2.8	2.8	19.0	10.5	4.2	1.7	1.7	⚡	100
ONKA - 8261- F1 - 6.4 AFC		0.8 x 6.4	6.4	22.0	10.5	4.2	1.7	1.7		100

ONKA - 8262- F2 - 6.4 AFC	1.5 ~ 2.5 mm 16 ~ 14 AWG	0.8 x 6.4	6.4	7.9	22.0	10.5	4.9	2.3	⚡	100
---------------------------	-----------------------------	-----------	-----	-----	------	------	-----	-----	---	-----

ONKA - 8263- F5 - 6.4 AFC	4.0 ~ 6.0 mm 12 ~ 10 AWG	0.8 x 6.4	6.4	24.5	13.0	6.5	3.4	3.4	⚡	100
---------------------------	-----------------------------	-----------	-----	------	------	-----	-----	-----	---	-----

PVC İZOLELİ FASTON ERKEK / DİŞİ GERİ DÖNÜŞLÜ KABLO UCU



Pirinç Malzemedен Kalay Kaplı,
PVC İzoleli,
75 °C Çalışma Sıcaklığı,
600 Volt Çalışma Gerilimi

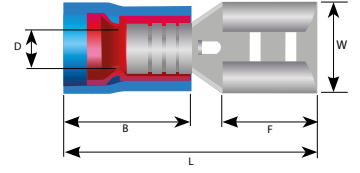
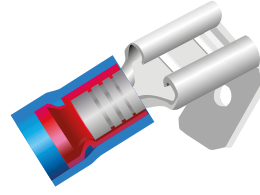

0,5 ~ 1,5 mm², Kablo Kesiti

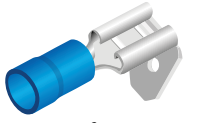

1,5 ~ 2,5 mm², Kablo Kesiti

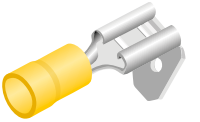

4,0 ~ 6,0 mm², Kablo Kesiti

ÜRÜN KODU	SOKET GENİŞLİĞİ	W	F	L	B	D	ADET (t)	KUTU ADEDİ
ONKA - 8280-PB1-6.4 VD	0.8 x 6.35	6.6	6.35	8.0	8.2	3.8		100
ONKA - 8281-PB2-6.4 VD	0.8 x 6.35	6.6	6.35	8.0	10.0	4.7	Ⓢ	100
ONKA - 8282-PB5 -6.4 VD	0.8 x 6.35	6.6	6.35	8.0	8.2	6.2		100

İZOLELİ BAYRAK TİP KABLO UCU



Pirinç Malzemedен Kalay Kaplı, PVC İzoleli,
105 °C Çalışma Sıcaklığı,
300 Volt Çalışma Gerilimi

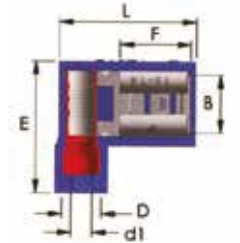

ÜRÜN KODU	KABLO KESİTİ	RENK	SOKET GENİŞLİĞİ	B	L	F	E	D	d1	ADET (t)	KUTU ADEDİ
ONKA-8225-FL1-6.4AC	0,5 - 1,5 mm ²	Kırmızı	0.8 x 6.4	6.6	7.9	16.1	15.0	4.5	1.7		100
ONKA-8226-FL2-6.4AC	1,5- 2,5 mm ²	Mavi	0.8 x 6.4	6.6	7.9	16.1	15.0	4.5	1.7	Ⓢ	100

İZOLELİ EK MUFLAR



Pirinç Malzemedен Kalay Kaplı, PVC İzoleli,
75 °C Çalışma Sıcaklığı,
300 Volt Çalışma Gerilimi



ÜRÜN KODU	KABLO KESİTİ (mm ²)	L	d	D	ADET (t)	KUTU ADEDİ
ONKA-8215-BB 1V	0,5 - 1,5	26.0	1.7	4.1		100
ONKA-8216-BB 2V	1,5 - 2,5	26.0	2.3	4.5	Ⓢ	100
ONKA-8217-BB 5V	4,0 - 6,0	27.0	3.4	6.5		100

İĞNE TİP PVC İZOLELİ KABLO UÇLARI



Bakır malzemeden, kalay kaplı, PVC izoleli,
75 °C çalışma sıcaklığı,
600 Volt Çalışma Gerilimi

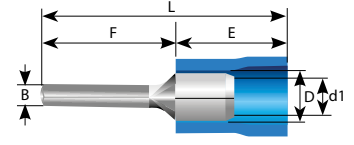

ÜRÜN KODU	B	L	F	E	D	d1	ADET (t)	KUTU ADEDİ
ONKA-8186-PT1-10V	1.9	20.5	10.5	10.0	4.1	1.7	⚡	200
ONKA-8187-PT2-10V	1.9	20.5	10.5	10.0	4.5	2.3		200
ONKA-8188-PT2-12V	1.9	22.5	12.5	10.0	4.5	2.3		200
ONKA-8189-PT2-18V	1.9	28.5	18.5	10.0	4.5	2.3	100	
ONKA-8190-PT5-13V	2.8	26.2	13.7	12.5	6.5	3.4	⚡	100

BIÇAK TİP PVC İZOLELİ KABLO UÇLARI

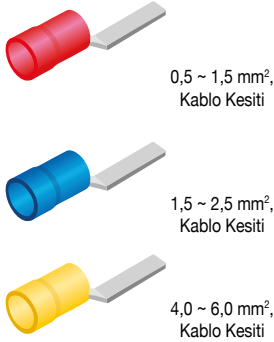

Bakır malzemeden kalay kaplı, Naylon izoleli,
105 °C çalışma sıcaklığı,
600 Volt Çalışma Gerilimi

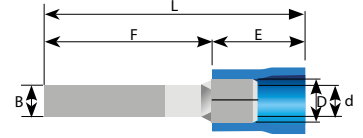

ÜRÜN KODU	B	L	F	E	D	d1	ADET (t)	KUTU ADEDİ
ONKA-8191-BT1-10A	2.4	21.5	10.5	11.0	4.1	1.7	⚡	100
ONKA-8192-BT1-14A	3.0	22.0	11.0	11.0	4.1	1.7		100
ONKA-8193-BT1-18A	3.0	25.0	14.0	11.0	4.1	1.7		100
ONKA-8194-BT2-9A	2.8	20.0	9.0	11.0	4.5	2.3	⚡	100
ONKA-8195-BT2-18A	2.4	29.0	18.0	11.0	4.5	2.3		100
ONKA-8196-BT5-18A	3.0	31.0	18.0	13.0	6.5	3.4	⚡	100

UCU KIVRIK İZOLELİ BIÇAK TERMİNALER

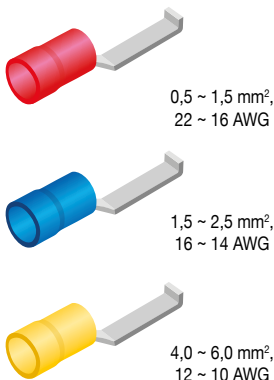

Bakır malzemeden kalay kaplı, Naylon izoleli,
105 °C çalışma sıcaklığı,
600 Volt Çalışma Gerilimi

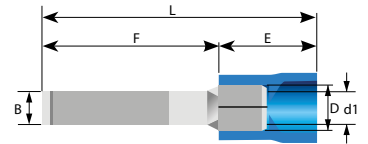

ÜRÜN KODU	B	F	L	E	D	d1	ADET (t)	KUTU ADEDİ
ONKA-LB1-3V	3.0	18.0	29.0	11.0	4.1	1.7	⚡	200
ONKA-LB1-4.6V	4.6	18.0	29.0	11.0	4.1	1.7		200
ONKA-LB2-3V	3.0	18.0	29.0	11.0	4.5	2.3	⚡	100
ONKA-LB2-4.6V	4.6	18.0	29.0	11.0	4.5	2.3		100
ONKA-LB5-3V	3.0	17.5	30.5	13.0	6.5	3.4	⚡	100
ONKA-LB5-4.6V	4.6	17.5	30.5	13.0	6.5	3.4		100

TAM İZOLELİ ERKEK TERMİNAL & T BAĞLANTI TERMİNALİ

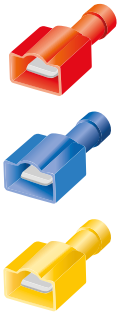
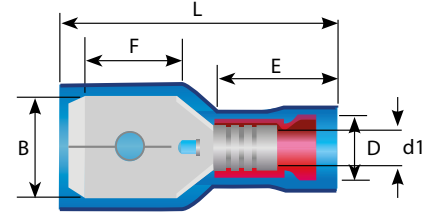
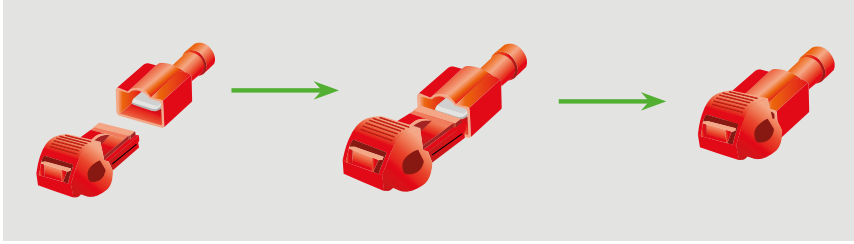

ÜRÜN KODU	KABLO KESİTİ (mm ²)	B	F	L	E	D	d1	ADET (t)	KUTU ADEDİ
ONKA-M1-6.4AFC	0.5 ~ 1.5 mm 22 ~ 16 AWG	6.35	7.9	23.5	10.5	4.2	1.7		100
ONKA-M2-6.4AFC	1.5 ~ 2.5 mm 16 ~ 14 AWG	6.35	7.9	23.5	10.5	4.9	2.3	Ⓢ	100
ONKA-M5-6.4AFC	4.0 ~ 6.0 mm 12 ~ 10 AWG	6.35	7.9	27.0	13.0	6.5	3.4		100

ÇENGEL İZOLELİ KABLO UCU

EXTRA ÇİFT YÜKSÜKLÜ

Pirinç Malzemeden Kalay Kaplı, PVC İzoleli,
75 °C Çalışma Sıcaklığı,
300 Volt Çalışma Gerilimi

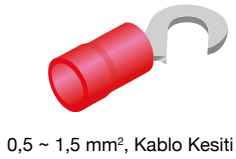
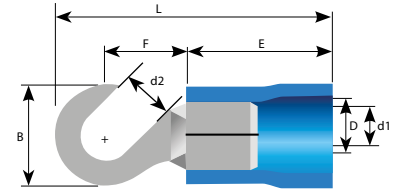

ÜRÜN KODU	METRİK ÖLÇÜ (d2)	B	L	F	E	D	d1	ADET (t)	KUTU ADEDİ
ONKA - 8290-H1-4V	4.3	8.0	21.0	7.0	10.0	4.1	1.7		200
ONKA - 8291-H1-5V	5.3	8.0	21.0	7.0	10.0	4.1	1.7	Ⓢ	200
ONKA - 8292-H1-6V	6.5	11.6	26.8	11.1	10.0	4.1	1.7		200

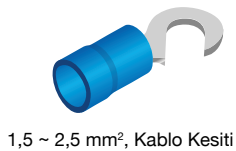

ONKA - 8293-H2-4V	4.3	8.5	22.0	7.8	10.0	4.5	2.3		200
ONKA - 8294-H2-5V	5.3	9.5	22.0	7.3	10.0	4.5	2.3	Ⓢ	200
ONKA - 8295-H2-6V	6.5	12.0	27.0	11.0	10.0	4.5	2.3		200



ONKA - 8296-H5-4V	4.3	9.5	25.5	8.3	12.5	6.5	3.4		100
ONKA - 8297-H5-5V	5.3	9.5	25.0	8.3	12.5	6.5	3.4	Ⓢ	100
ONKA - 8298-H5-6V	6.5	12.0	29.0	10.5	12.5	6.5	3.4		100

İZOLELİ KURŞUN ERKEK KABLO UCU



0,5 ~ 1,5 mm², Kablo Kesiti



1,5 ~ 2,5 mm², Kablo Kesiti



4,0 ~ 6,0 mm², Kablo Kesiti

Bakır malzemeden, kalay kaplı, PVC izoleli,
75 °C çalışma sıcaklığı,
600 Volt Çalışma Gerilimi

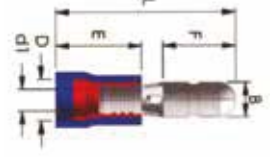

ÜRÜN KODU	B	F	L	E	D	d1	ADET (t)	KUTU ADEDİ
ONKA-8200-BD1-4VD	4.0	8.5	21.0	10.0	4.3	1.7	⚡	200
ONKA-8201-BD2-4VD	4.0	8.5	21.0	10.0	4.3	2.3	⚡	200
ONKA-8202-BD2-5VD	5.0	8.5	21.0	10.0	5.0	2.3		200
ONKA-8203-BD5-5VD	5.0	8.5	23.5	13.0	6.5	3.4	⚡	100

TAM İZOLELİ KURŞUN DIŞI KABLO UCU

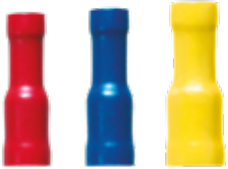

0,5 ~ 1,5 mm², Kablo Kesiti



1,5 ~ 2,5 mm², Kablo Kesiti



4,0 ~ 6,0 mm², Kablo Kesiti

Bakır malzemeden, kalay kaplı, PVC izoleli,
75 °C çalışma sıcaklığı,
300 Volt Çalışma Gerilimi

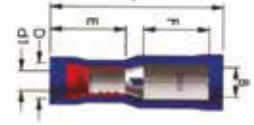

ÜRÜN KODU	B	F	L	E	D	d1	ADET (t)	KUTU ADEDİ
ONKA-8210-RE1-4VFD	4.0	9.0	23.5	11.0	4.3	1.7	⚡	100
ONKA-8211-RE2-4VFD	4.0	9.0	23.5	11.0	5.0	2.3	⚡	100
ONKA-8212-RE2-5VFD	5.0	9.0	23.5	11.0	5.0	2.3		100
ONKA-8213-RE5-5VFD	5.0	9.0	25.0	13.0	6.5	3.4	⚡	100

HIZLI KABLO EK YAPMA APARATI



Plastik, Metal
105 °C çalışma sıcaklığı,
600 Volt Çalışma Gerilimi

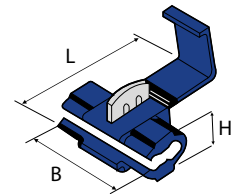

ÜRÜN KODU	KABLO KESİTİ (mm ²)	B	H	D	ADET (t)	KUTU ADEDİ
TB-1	0,5 - 1,0	20.0	8.0	25.0	⚡	100
TB-2	1,0 - 2,5	20.0	8.0	25.0		100
TB-5	4,0 - 6,0	20.0	11.0	35.0		100

Onka®

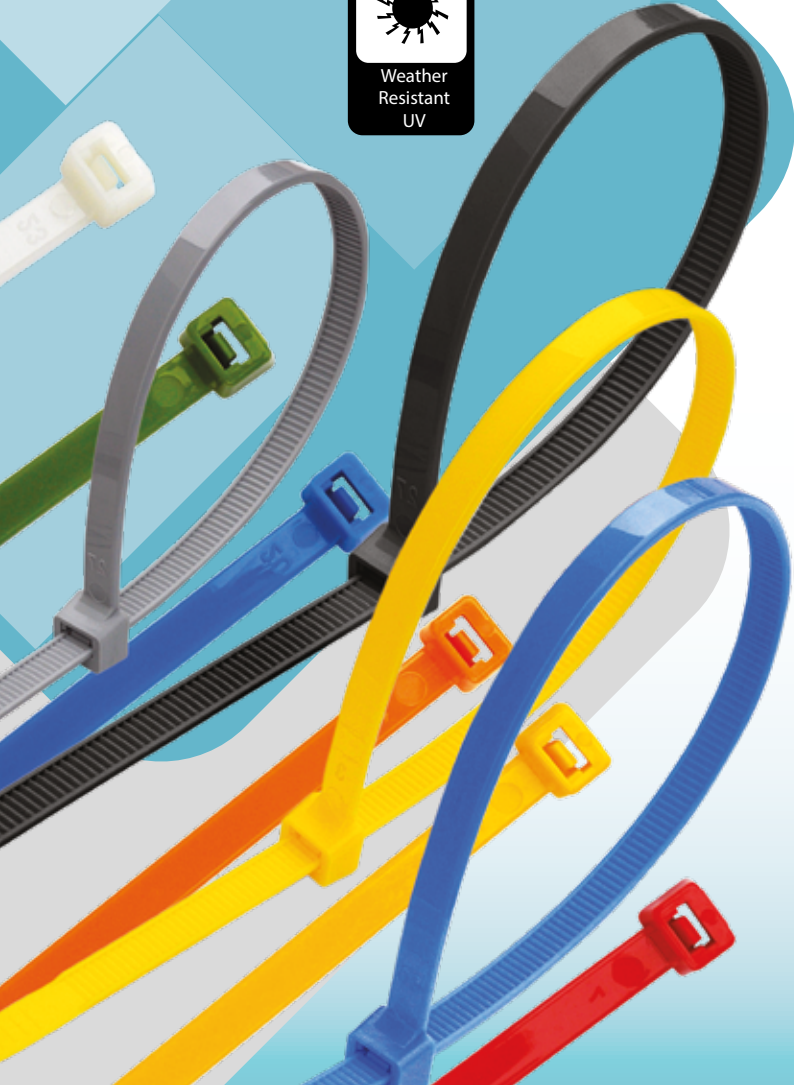
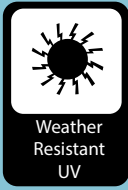
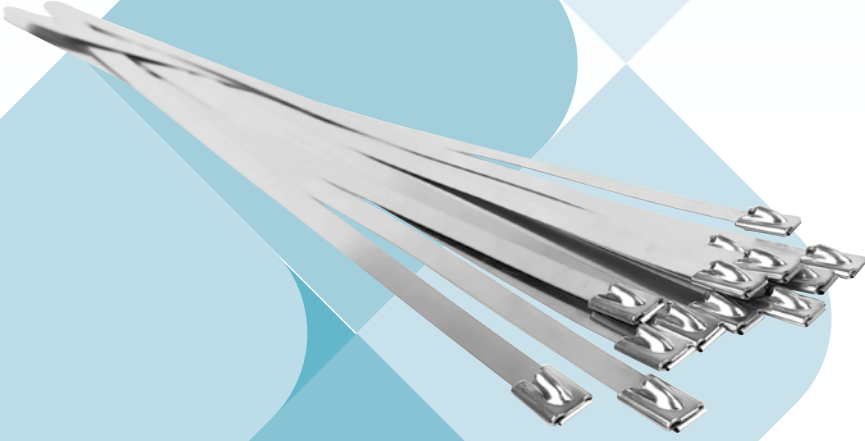

KABLO BAĞLARI ve AKSESUARLARI



KABLO BAĞLARI

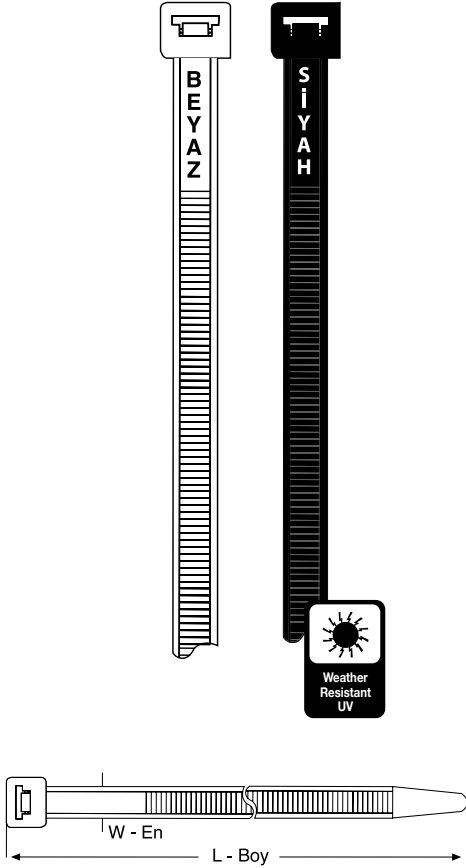

ÜRÜN KODU	L	W	MAK. BAĞLAMA ÇAPI	TAŞI. AĞIRLIK (kg)	ADET (t)	POŞET ADEDİ	KOLİ ADEDİ
ONKA-8480	100	2,5	22	8,00	☎	100 / 1000	26.000
ONKA-8432	150	2,5	35	8,00		100 / 1000	20.000
ONKA-8482	200	2,5	50	8,00		100 / 1000	18.000
ONKA-8483	140	3,5	31	18,00		100 / 1000	12000
ONKA-8484	200	3,5	50	18,00		100 / 1000	10000
ONKA-8485	250	3,5	65	18,00		100 / 1000	8000
ONKA-8486	280	3,5	74	18,00		100 / 1000	8000
ONKA-8487	370	3,5	98	18,00		100 / 1000	6000
ONKA-8489	200	4,5	50	22,00		100	7.000
ONKA-8490	250	4,5	65	22,00		100	6.000
ONKA-8491	300	4,5	80	22,00		100	5.000
ONKA-8492	370	4,5	102	22,00		100	4.000
ONKA-8493	430	4,5	120	22,00		100	3.000
ONKA-8495	300	7,5	75	55,00		100	3.000
ONKA-8496	370	7,5	98	55,00		100	2.500
ONKA-8497	450	7,5	120	55,00		100	2.000
ONKA-8498	550	7,5	155	55,00	100	1.500	
ONKA-8514	750	7,5	220	55,00	100	1200	
ONKA-8507	600	9,0	165	80,00	100	1.200	
ONKA-8502	710	9,0	205	80,00	100	1.200	
ONKA-8524	760	9,0	220	80,00	100	1.200	
ONKA-8504	900	9,0	260	80,00	100	1.200	
ONKA-8505	1200	9,0	370	80,00	100	1.000	

RENKLİ KABLO BAĞLARI

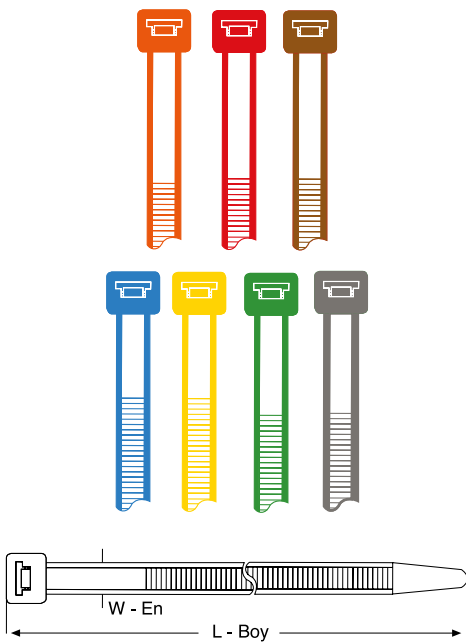

ÜRÜN KODU	L	W	MAK. BAĞLAMA ÇAPI	TAŞI. AĞIRLIK (kg)	ADET (t)	POŞET ADEDİ	KOLİ ADEDİ
ONKA - 8178	100	2.5	22	8.1	☎	1000	80.000
ONKA - 8179	140	2.5	40	8.1		100	50.000
ONKA - 8180	200	2.5	53	8.1		100	35.000
ONKA - 8181	150	3.6	35	18.2		100	30.000
ONKA - 8182	200	3.6	53	18.2		100	25.000
ONKA - 8183	250	3.6	65	18.2		100	20.000
ONKA - 8184	300	3.6	76	18.2		100	20.000
ONKA - 8152	200	4.8	50	22.2		100	17.000
ONKA - 8154	250	4.8	102	22.2		100	15.000
ONKA - 8185	300	4.8	76	22.2		100	15.000
ONKA - 8205	370	4.8	102	22.2		100	12.000
ONKA - 8209	370	8	102	54.5		100	6.000
ONKA - 8218	450	8	127	54.5		100	3.500
ONKA - 8219	530	8	140	54.5		100	3.000

ONKA ürünleri DUPONT marka, nylon 6/6 hammaddeden imal edilmiş olup, - 40 + 85 °C ortam sıcaklığında çalışır. UL 94 / V2 normunda, kendini söndürme özelliğine sahiptir. Yüksek kaliteli ONKA kablo bağları (benzin, motorin, hayvansal yağ, boya, vernik) gibi maddelere karşı üstün direnç göstermektedir. Ürünler beyaz / siyah ve yandaki renkler olarak STOKLARIMIZDA mevcuttur. Beyaz / siyah renk dışındaki kablo bağlarının fiyatları farklıdır. Diğer renk istekleriniz için firmamızla iletişime geçiniz.

Siyah renkli ürünlerimiz dış ortam kullanımına uygun UV dayanımlıdır.

ÖZEL KABLO BAĞLARI



KULLANIM ALANLARI

Gıda ve ilaç endüstrilerinde kullanılan tipik metal dedektörleri, metal algılama sistemleri ve X-Ray kontrol sistemleri tarafından algılanma ve reddedilme yeteneğine sahiptir.

Özellikle gıda ve ilaç endüstrilerinde hammadde, yarımamül, diğer ürün yan girdi ambalajları, poşet, torba, çuval ağzlarının bağlanmasında, üretim hatlarındaki elektrik kablo, boru ve boru demetlerinin bağlanmasında ve diğer tesisatların sabitlenmesinde, ürünü kirletme riski bulunan makine aksamlarının sabitlenmesinde vb... ve diğer bir çok uygulama alanında kullanılmak üzere tasarlanmıştır. Kuvvetli ve dayanıklı malzemelerden Naylon 6, Naylon 6.6, Polypropilen malzemelerden yapılmıştır.

Ürün boyunca dağıtılmış metal içeriğe sahiptir ve bu sebeple parçalar halinde kesilseler dahi tespit edilebilme özelliğine sahiptir.

Genel Özellikler :

- Metal algılama sistemleri (metal dedektörü ve mıknatıs) tarafından tespit edilebilir,
- X-Ray kontrol sistemleri tarafından tespit edilebilir,
- HACCP sisteminin bir parçası olarak kullanılabilir,
- Farklı renk seçenekleri mevcuttur (sadece DTMN 0500 ürünü için geçerli),
- Uygun maliyetlidir,
- Çevre dostudur.

METAL
DEDEKTÖRLERİX-RAY KONTROL
SİSTEMLERİENDÜSTRİYEL
MIKNATISLAR

KİLİTLİ KABLO BAĞI

ÜRÜN KODU	RENK	BOY (mm)	EN (mm)	ADET (t)	POŞET ADEDİ
DTMN 01523	MAVİ	92	2,4	Ⓢ	100
DTMN 01525		186	4,8		
DTMN 01527		340	7		
DTMN 01528		360	4,8		

KABLO BAĞI

ÜRÜN KODU	RENK	BOY (mm)	EN (mm)	ADET (t)	POŞET ADEDİ
DTMN 01529	MAVİ	150	3,5	Ⓢ	100
DTMN 01530		200	4,6		
DTMN 01531		145	3,4		
DTMN 01532		185	4,6		
DTMN 01533		380	4,7		
DTMN 01540		390	7,6		

RENKLİ KABLO BAĞI

ÜRÜN KODU	RENK	BOY (mm)	EN (mm)	ADET (t)	POŞET ADEDİ
DTMN 0500	MAVİ	390	4,6	Ⓢ	100
	KIRMIZI				
	SARI				
	YEŞİL				
	TURUNCU				

TEKRAR KULLANILABİLİR KABLO BAĞI

ÜRÜN KODU	RENK	BOY (mm)	EN (mm)	ADET (t)	POŞET ADEDİ
DTMN 01539	MAVİ	250	4,7	Ⓢ	100

PASLANMAZ ÇELİK KABLO BAĞLARI

(AISI 304-316 Paslanmaz Çelik)

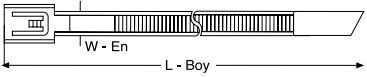

ÜRÜN KODU	L	W	MAK. BAĞLAMA ÇAPI	TAŞI. AĞIRLIK (kg)	ADET (t) 304 PASLANMAZ	ADET (t) 316 PASLANMAZ	POŞET ADEDİ	KOLİ ADEDİ
ONKA - 8600	127	4.6	25.0	46	Ⓢ	Ⓢ	100	8000
ONKA - 8601	152	4.6	37.0	46			100	8000
ONKA - 8602	201	4.6	50.0	46			100	6000
ONKA - 8603	266	4.6	69.0	46			100	6000
ONKA - 8604	300	4.6	76.0	46			100	4000
ONKA - 8605	362	4.6	102	46			100	4000
ONKA - 8606	521	4.6	152	46			100	3000
ONKA - 8607	679	4.6	203	46			100	2000
ONKA - 8608	838	4.6	254	46			100	2000
ONKA - 8609	152	7.9	25.0	114			100	4000
ONKA - 8610	201	7.9	50.0	114			100	3000
ONKA - 8611	266	7.9	69.0	114			100	3000
ONKA - 8612	300	7.9	76.0	114			100	2000
ONKA - 8613	362	7.9	102	114			100	2000
ONKA - 8614	521	7.9	152	114			100	1500
ONKA - 8615	679	7.9	203	114			100	1000
ONKA - 8616	838	7.9	254	114	100	1000		

PVC KAPLI ÇELİK KABLO BAĞLARI

(AISI 304 Paslanmaz Çelik)



ÜRÜN KODU	L	W	MAK. BAĞLAMA ÇAPI	TAŞI. AĞIRLIK (kg)	ADET (t)	POŞET ADEDİ	KOLİ ADEDİ
GTME-PVC-127 ST	127	4.6	15	55	Ⓢ	100	8000
GTME-PVC-152 ST	152	4.6	44	55		100	8000
GTME-PVC-201 ST	201	4.6	51	55		100	6000
GTME-PVC-266 ST	266	4.6	69	55		100	6000
GTME-PVC-300 ST	300	4.6	76	55		100	4000
GTME-PVC-362 ST	362	4.6	102	55		100	4000
GTME-PVC-521 ST	521	4.6	152	55		100	3000
GTME-PVC-679 ST	679	4.6	203	55		100	2000
GTME-PVC-838 ST	838	4.6	254	55		100	2000
GTME-PVC-152 HD	152	7.9	44	120		100	4000
GTME-PVC-201 HD	201	7.9	51	120		100	3000
GTME-PVC-266 HD	266	7.9	69	120		100	3000
GTME-PVC-300 HD	300	7.9	76	120		100	2000
GTME-PVC-362 HD	362	7.9	102	120		100	2000
GTME-PVC-521 HD	521	7.9	152	120		100	1500
GTME-PVC-679 HD	679	7.9	203	120		100	1000
GTME-PVC-838 HD	838	7.9	254	120	100	1000	

PANELE KAFADAN SIKIŞAN KABLO BAĞI

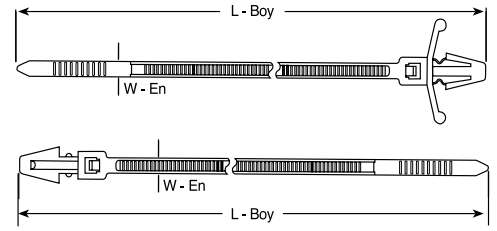

ÜRÜN KODU	L	W	MAKSİMUM BAĞLAMA ÇAPI	TAŞIMA AĞIRLIĞI (kg)	DELİK ÇAPI (Ø)	ADET (t)	POŞET ADEDİ
ONKA - 8380	100	2.5	22	12	Ø 4.8	100	
ONKA - 8382	200	4.8	46	25	Ø 6.4		

ETİKETLİ KABLO BAĞI

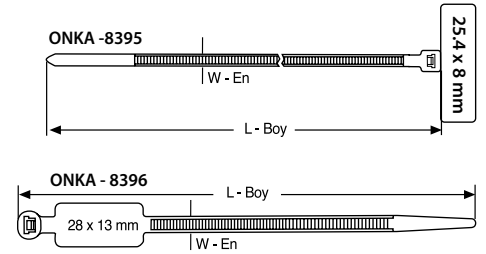
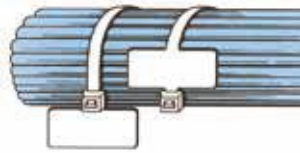
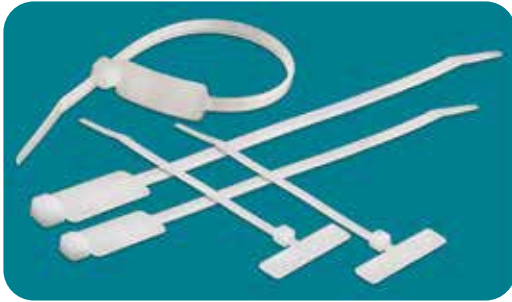

ÜRÜN KODU	L	W	MAKSİMUM BAĞLAMA ÇAPI	TAŞIMA AĞIRLIĞI (kg)	ADET (t)	POŞET ADEDİ
ONKA - 8395	100	2.5	18	8.1	100	
ONKA - 8396	195	4.8	45	22.2		

KAFADAN VİDA MONTAJLI KABLO BAĞI

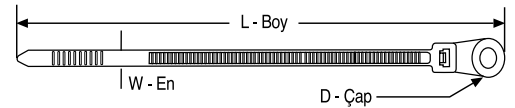

ÜRÜN KODU	L	W	D	MAKSİMUM BAĞLAMA ÇAPI	TAŞIMA AĞIRLIĞI (kg)	ADET (t)	POŞET ADEDİ
ONKA - 8411	200	4,8	4,8	54	22,2	1000	

BONCUK TİP KABLO BAĞI



ÜRÜN KODU	L	W	MAKSİMUM BAĞLAMA ÇAPI	TAŞIMA AĞIRLIĞI (kg)	ADET (t)	POŞET ADEDİ
GTB-110 M	105	2	25	5	500	
GTB-150 I	165	3.5	45	7		

BÜKÜLEBİLİR KLİPS

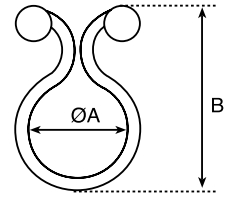

ÜRÜN KODU	ÜRÜN CİNSİ	ØA	B	MAKSİMUM BAĞLAMA ÇAPı	ADET (t)	POŞET ADEDİ
ONKA-8370	TH-D	11,2	28,4	10,2	Ⓣ	1000
ONKA-8371	TH-E	5,2	21,0	4,5		1000
ONKA-8372	TH-F	8,3	25,2	7,3		1000
ONKA-8373	TH-G	11,5	30,9	10,5		1000
ONKA-8374	TH-H	15,0	35,1	14,0		1000
ONKA-8375	TH-I	18,0	40,0	17,0		1000
ONKA-8376	TH-J	19,5	42,5	19,0		1000
ONKA-8377	TH-K	22,5	45,5	22,0		1000
ONKA-8378	TH-L	5,2	22,0	5,0		1000

FLAT CABLE KABLO TUTUCUSU

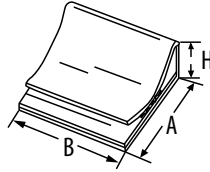

ÜRÜN KODU	A	B	H	ADET (t)	KUTU ADEDİ
ONKA-8433	15	26	6,5	Ⓣ	100
ONKA-8434	25	26	10		100

TABANI YAPIŞKANLI KANCALI KLİPS

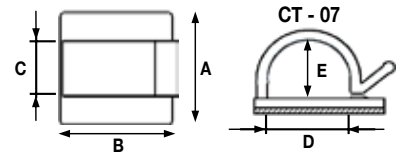

ÜRÜN KODU	A	B	C	D	MAKS. BAĞLAMA GENİŞLİĞİ (E)	ADET (t)	POŞET ADEDİ
CT-05	25	25	12,7	12,5	8	Ⓣ	100
CT-07	25	25	12,7	16,5	12		100

VİDALI KROŞELER

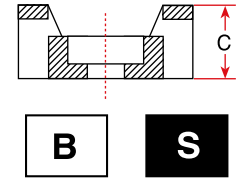
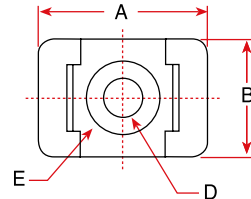

ÜRÜN KODU	A	B	C	D	E	MAKS. BAĞLAMA GENİŞLİĞİ	ADET (t)	POŞET ADEDİ
ONKA-8360	2	14,9	9,5	6,9	4,5	7,8	Ⓣ	100
ONKA-8361	3	22,2	15,9	9,7	6,4	12,6		100
ONKA-8595	5	30,0	15,0	11,7	4,8	-		100

KABLO SIKIŞTIRICILARI

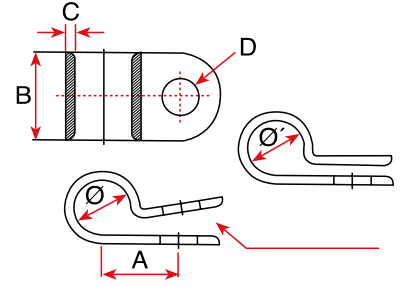

ÜRÜN KODU	Ø	Ø'	A	B	C	D	ADET (t)	POŞET ADEDİ
ONKA - 8450 1/8S	3.6	3.3	8.2	9.1	1.27	M 5	⚡	100
ONKA - 8451 3/16S	5.3	4.8	9.6	9.1	1.27	M 5		100
ONKA - 8452 1/4S	7.4	6.6	10.3	9.1	1.27	M 5		100
ONKA - 8453 5/16S	8.9	7.8	10.6	9.1	1.27	M 5		100
ONKA - 8454 3/8S	10.9	9.7	11.9	9.2	1.27	M 5		100
ONKA - 8457 3/8	9.5	9.1	13.4	12.7	1.50	M 5		100

BETON KROŞE

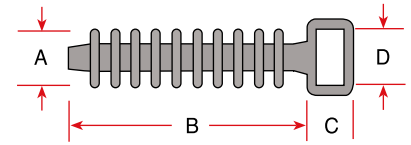

ÜRÜN KODU	A	B	C	D	MAKS. BAĞLAMA GENİŞLİĞİ	ADET (t)	KUTU ADEDİ
ONKA - 8362	9,5	36,0	6,0	9,5	9,5	⚡	100

BASKILI DEVRE TAŞIYICILARI

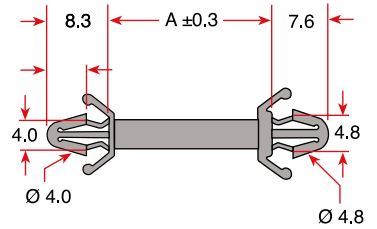

ÜRÜN KODU	ÖLÇÜ (A)	ADET (t)	KUTU ADEDİ
ONKA-8420 CBS-6A	6,2	⚡	1000
ONKA-8421 CBS-9A	9,2		1000
ONKA-8422 CBS-13A	12,6		1000
ONKA-8423 CBS-16A	15,8		1000
ONKA-8424 CBS-19A	19,1		1000



SOKETLİ PCB KLEMENS SERİSİ (3.81mm)

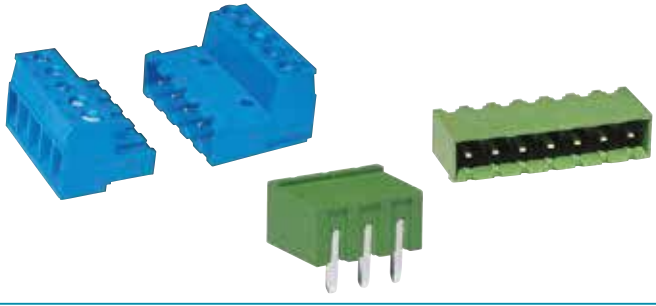

GÜÇ KLEMENSİ (3.81 x 12.7 x 15.24 mm)



SOKETLİ PCB KLEMENS SERİSİ (5.08mm)

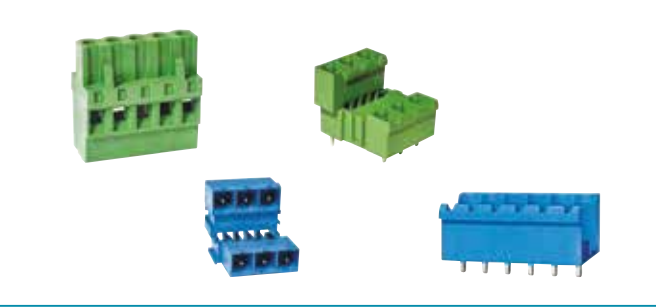

VİDASIZ KLEMENS SERİSİ

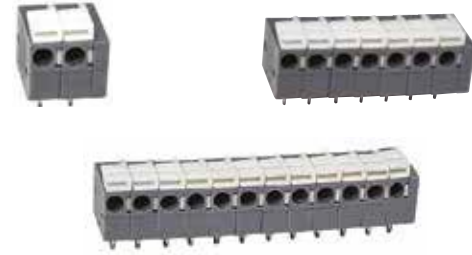

SOKETLİ PCB KLEMENS SERİSİ (5.08mm)

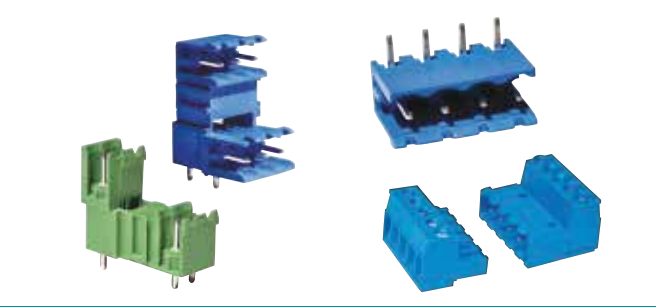

SMD KLEMENS SERİSİ



SOKETLİ PCB KLEMENS SERİSİ (7.62mm)

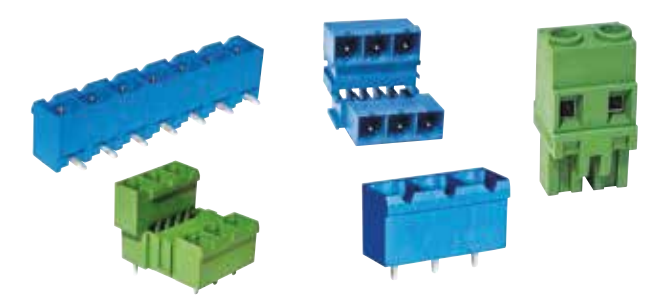

MODÜL PCB KLEMENS SERİSİ



KART YUVASI SERİSİ

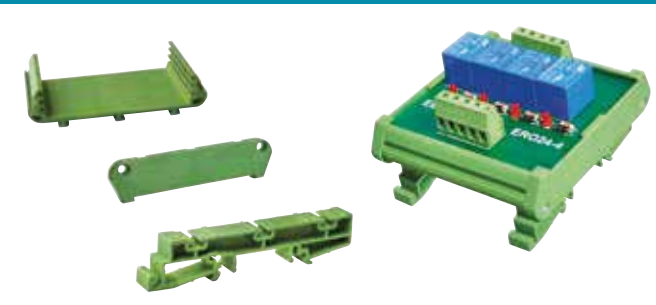

DİSTANS SERİSİ (RAY DİSTANS)

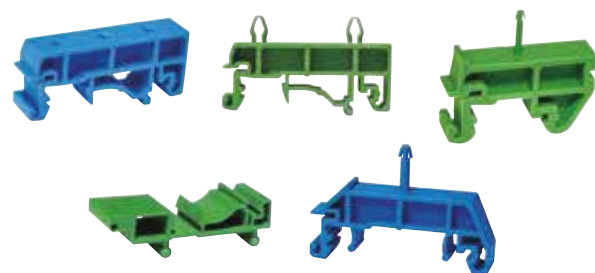

DİYOT MODÜLLERİ

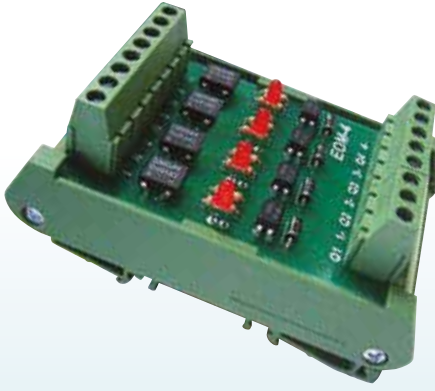

Diyot Kartları

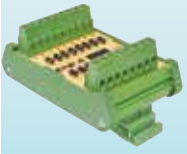

Özelliği : 7 farklı tipte imal edilmektedirler. 6'lı, 12'li, 14'lü ortak anot, 14'lü ortak katot, 22'li ortak anot ve 22'li ortak katot şeklindedir. Diyot ihtiyaç olan yerlerde klemens bağlantısı olmasından dolayı tercih edilir. Diyotlar 1 A ve 700 V olarak kullanılmaktadır..

Lamba Test Kartları



Özelliği : Makina veya elektrik panosundaki sinyal lambalarını kontrol eder. 8 - 11 - 16 kanallı 3 tip imal edilmektedir.

Optokupler Modülleri



Özelliği: PLC veya micro işlemcili sistemlerde güç devresi ile elektronik devreyi elektriksel olarak birbirlerinden izole ederek PLC veya mikro işlemcinin bozulmasını engeller. Bu kartımız PLC veya mikro işlemciye giriş/çıkış olarak kullanılır. 4 kanalıdır. Genellikle giriş sinyallerinin güçlendirilmesi ve izole edilmesi için tercih edilir. Kartımızın girişi 5 V DC -12 - 24 V DC çıkışı ise 24 V DC, NPN 'dir (Yani "-" çıkış). Her iki devrede izole halindedir. Üzerindeki LED ile çalışması takip edilebilir.

DİYOT MODÜLLERİ

OPTOKUPLER MODÜLÜ



YENİ KOD	ESKİ KOD	AÇIKLAMA	ADET (t)
1050011	ONKA-130-EOM-4	Optokupler Kartı 4 Kanallı 5 VDC Giriş, 24 VDC Çıkış, NPN	1.025,00
1050012	ONKA-131-EOM-4	Optokupler Kartı 4 Kanallı 12 VAC / DC Giriş, 24 VDC Çıkış, NPN	1.025,00
1050013	ONKA-132-EOM-4	Optokupler Kartı 4 Kanallı 24 VAC / DC Giriş, 24 VDC Çıkış, NPN	1.025,00

LAMBA TEST MODÜLLERİ

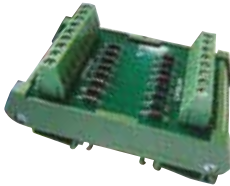

YENİ KOD	ESKİ KOD	AÇIKLAMA	ADET (t)
1050008	ONKA-120-ELT8	Lamba Test Kartı 8 Kanallı	528,00
1050010	ONKA-122-ELT11	Lamba Test Kartı 11 Kanallı	580,00
1050009	ONKA-121-ELT16	Lamba Test Kartı 16 Kanallı	694,00

DİYOT KARTLARI



YENİ KOD	ESKİ KOD	AÇIKLAMA	ADET (t)
1050001	ONKA-101-EDM6	Diyot Kartı 6 Kanallı	440,00
1050002	ONKA-102-EDM8	Diyot Kartı 8 Kanallı	503,00
1050003	ONKA-103-EDM12	Diyot Kartı 12 Kanallı	523,00
1050004	ONKA-104-EDM14A	Diyot Kartı 14 Kanallı Ortak Anot	577,00
1050005	ONKA-105-EDM14K	Diyot Kartı 14 Kanallı Ortak Katot	577,00
1050006	ONKA-106-EDM22A	Diyot Kartı 22 Kanallı Ortak Anot	605,00
1050007	ONKA-107-EDM22K	Diyot Kartı 22 Kanallı Ortak Katot	605,00

PARAFUDR (AŞIRI GERİLİM KORUMA)



EP-D20/1P

T2 Uc:275V,In:10kA,
I_{max}:20kA
(1 Faz, D Sınıfı, 20 kA)



EP-D10/1P

T3, Uc:320V,I_{max} 10kA
(1 Faz, D Sınıfı, 10 kA)



EP-D10/1+1

T3, Uc:320V,I_{max} 10kA
(1 Faz+N, D Sınıfı, 10 kA)



EP-B+C/50/1+1

T1+T2,Uc:280V,In:30kA,
I_{max}:50kA. I_{imp}:12.5kA
(1 Faz+N, B+C Sınıfı, 50 kA)



EP-12.5/B+C/1+1

T1+T2,Uc:275V,In:20kA,
I_{max}:50kA. I_{imp}:12.5kA
(1 Faz+N, B+C Sınıfı, 12,5 kA)



EP-C40/1+1

T2 Uc:275V,In:20kA,
I_{max}:40kA
(1 Faz+N, C Sınıfı, 40 kA)



EP-D20/3+1

T2 Uc:275V,In:10kA,
I_{max}:20kA
(3 Faz+N, D Sınıfı, 20 kA)



EP-C40/3+1

T2 Uc:275V,In:20kA,
I_{max}:40kA
(3 Faz+N, C Sınıfı, 40 kA)



EP-100B+C/3+1

T1+T2,Uc:230V/400V,
I_{max}:50kA. I_{imp}:12.5kA
(3 Faz+N, B+C Sınıfı, 50 kA)



EP-GS-100/3+1

T1+T2+T3, Uc:320V,In:30kA,
I_{max}:100kA. I_{imp}:8kA
(3 Faz+N, B+C Sınıfı, 100 kA)



EP-100B/3+1

T1,Uc:280V,In:60kA,
I_{max}:100kA. I_{imp}:12.5kA
(3 Faz+N, B Sınıfı, 100 kA)



EP-C40 DC 2P 1000V

T2 Uc:1000V,In:20kA,
I_{max}:40kA
(DC, C Sınıfı, 40 kA)



EP-C40PV 1000V

T1+T2 Uc:1000V,In:20kA,
I_{max}:40kA, I_{imp}:6.25kA
(3 Faz 1000V DC, C Sınıfı, 40 kA)



EP-C40PV 1500V

T1+T2 Uc:1500V,In:20kA,
I_{max}:40kA, I_{imp}:6.25kA
(3 Faz 1500V DC, C Sınıfı, 40 kA)



EP-C40 DC 3P 1000V

T2 Uc:1000V,In:20kA,
I_{max}:40kA
(3 Faz 1000V DC, C Sınıfı, 40 kA)



EP-C40 DC 3P 1500V

T2 Uc:1500V,In:20kA,
I_{max}:40kA
(3 Faz 1500V DC, C Sınıfı, 40 kA)



KAEEL



YENİ

**AŞIRI VE DÜŞÜK GERİLİM
KORUMA RÖLESİ**



YENİ

**ÇİFT YÖNLÜ REAKTİF
GÜÇ DENGELİYİCİ**



YENİ

**SICAKLIK
KONTROL CİHAZLARI**



YENİ

SEVİYE KONTROL ve GERİLİM KORUMA RÖLELERİ



FAZ KORUMA RÖLELERİ



ZAMAN ve AKIM KORUMA RÖLELERİ



ÖZEL ve FOTOSEL RÖLELER





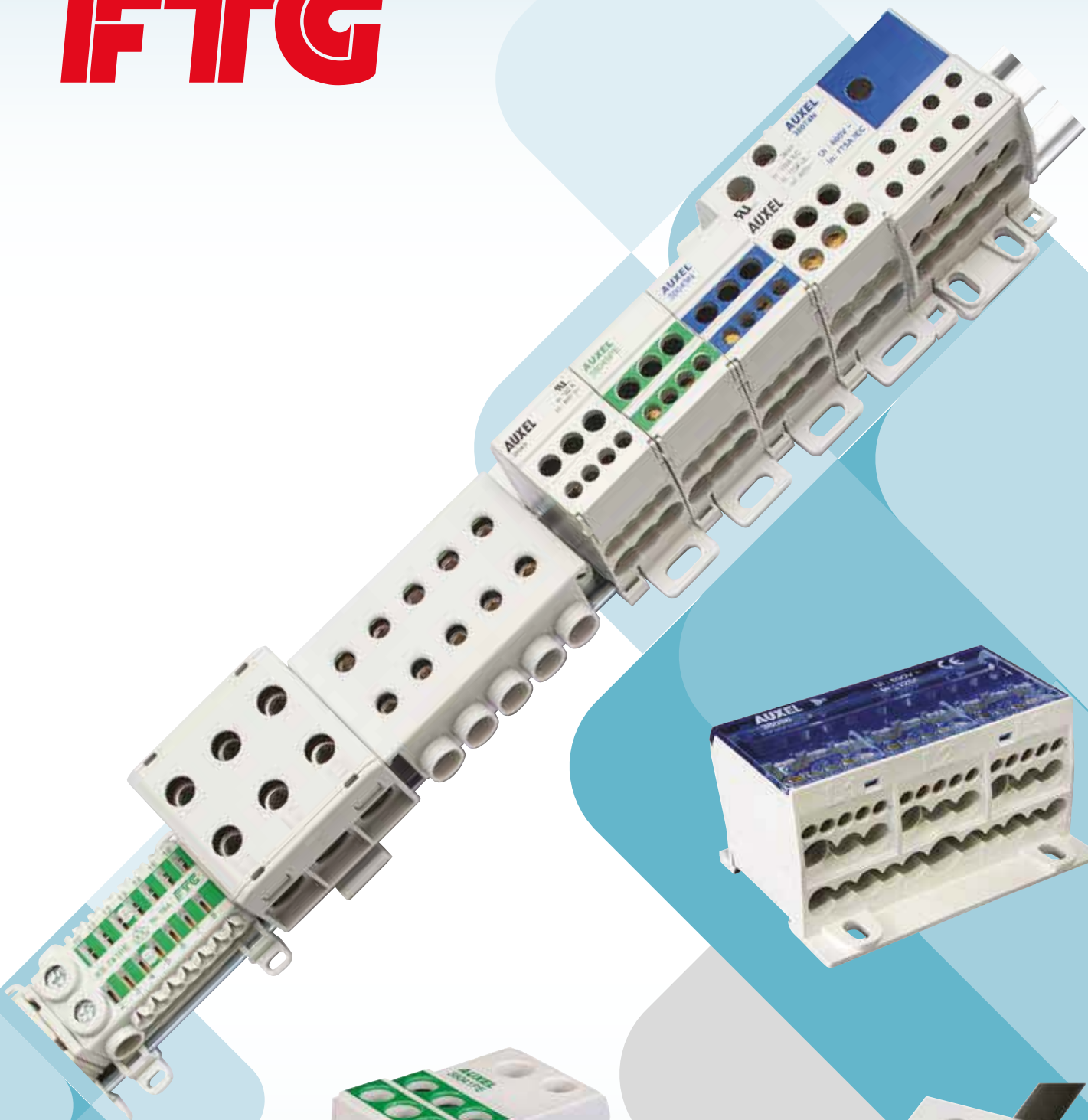



















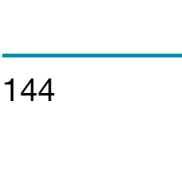

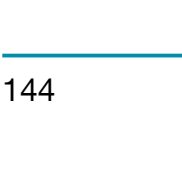

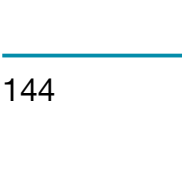

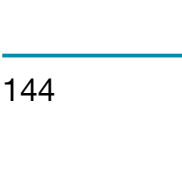
GÜÇ DAĞITIM BLOKLARI

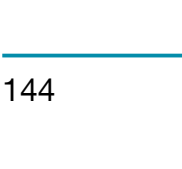
MONOBLOK DAĞITICI

ÜRÜN KODU	CİNSİ	ADET (€)	KUTU ADEDİ		ÜRÜN KODU	CİNSİ	ADET (€)	KUTU ADEDİ
	80 A Giriş: 1 x 2,5-16 mm ² Çıkış: 4 x 2,5 - 6 mm ² 2 x 2,5 - 16 mm ²	15,30 €	1		FTG-38404	400 A Giriş: 1 x 70 - 240 mm ² Çıkış: 2 x 35 - 120 mm ²	69,00 €	1
	80 A Yeşil Giriş: 1 x 2,5 - 16 mm ² Çıkış: 4 x 2,5 - 6 mm ² 2 x 2,5 - 16 mm ²	15,30 €	1		FTG-38404N	400 A Giriş: 1 x 70 - 240 mm ² Çıkış: 2 x 35 - 120 mm ²	69,00 €	1
	80 A Mavi Giriş: 1 x 2,5 - 16 mm ² Çıkış: 4 x 2,5 - 6 mm ² 2 x 2,5 - 16 mm ²	16,40 €	1		FTG-38404PE	400 A Giriş: 1 x 70 - 240 mm ² Çıkış: 2 x 35 - 120 mm ²	69,00 €	1
	125 A Giriş: 1 x 10-35 mm ² 1 x 6 - 16 mm ² Çıkış: 6 x 2,5 - 16 mm ²	29,40 €	1		FTG-38404R	400 A Giriş: 1 x 70 - 240 mm ² Çıkış: 2 x 35 - 120 mm ²	69,00 €	1
	125 A Giriş: 1 x 10-35 mm ² 1 x 6 - 16 mm ² Çıkış: 6 x 2,5 - 16 mm ²	29,40 €	1		FTG-38403	400 A Giriş: 1 x 70 - 240 mm ² Çıkış: 6 x 6 - 50 mm ²	69,00 €	1
	125 A Giriş: 1 x 16-35 mm ² 1 x 6 - 16 mm ² Çıkış: 6 x 2,5 - 16 mm ²	29,40 €	1		FTG-38403N	400 A Giriş: 1 x 70 - 240 mm ² Çıkış: 6 x 6 - 50 mm ²	69,00 €	1
	125 A Giriş: 1 x 16-35 mm ² Çıkış: 10 x 2,5 - 16 mm ²	44,90 €	1		FTG-38403PE	400 A Giriş: 1 x 70 - 240 mm ² Çıkış: 6 x 6 - 50 mm ²	69,00 €	1
	175 A Giriş: 1 x 16-70 mm ² Çıkış: 10 x 2,5 - 16 mm ²	44,90 €	1		FTG-38403R	400 A Giriş: 1 x 70 - 240 mm ² Çıkış: 6 x 6 - 50 mm ²	69,00 €	1
	175 A Mavi Giriş: 1 x 16 - 70 mm ² Çıkış: 10 x 2,5 - 16 mm ²	44,90 €	1		FTG-38402	400 A Bara Girişi : 20 x 4 - 25 x 10 mm Çıkış : 2 x 35 - 120 mm ²	70,00 €	1
	160 A Giriş: 1 x 10-70 mm ² Çıkış : 6 x 2,5 - 16 mm ² Bakır Bara Geçişli	46,40 €	1		FTG-38401	400 A Bara Girişi 5,5 x 0,8 x 1 mm 24 x 1 x 6 mm Çıkış : 6 x 6 - 50 mm ²	70,00 €	1
	250 A Giriş: 1 x 35 - 120 mm ² Çıkış : 2 x 6 - 35 mm ² 5 x 1,5 - 16 mm ² 4x1,5-10 mm ²	60,80 €	1		FTG-38062	800 A Bara Girişi 1 x 35 - 300 mm Bara Genişliği : 50 mm Çıkış 2 x 35 - 300 mm ²	86,00 €	1
	400 A Giriş: 1x95-185 mm ² Çıkış : 2 x 6 - 35 mm ² 5 x 1,5 - 16 mm ² 4 x 1,5 - 10 mm ²	65,20 €	1		FTG-38063	800 A Bara Girişi 2 x 35 - 300 mm Bara Genişliği : 20 mm Çıkış 2 x 35 - 300 mm ²	86,00 €	1

3 FAZLI MONOBLOK DAĞITICI



ÜRÜN KODU	CİNSİ	ADET (€)	KUTU ADEDİ
FTG-38056	125 A, (3 FAZ + NÖTR) Giriş: 1 x 10 - 35 mm ² Çıkış: 5 x 1,5 - 6, 2 x 2,5 - 16mm ²	40,00 €	1
FTG-38075	125 A, (3 FAZ) Giriş: 1 x 10 - 35 mm ² Çıkış: 6 x 2,5 - 16 mm ²	83,00 €	1
FTG-38073	175 A, (3 FAZ) Giriş: 1 x 16 - 70 mm ² Çıkış: 6 x 2,5 - 16 mm ²	87,00 €	1

GÜÇ DAĞITIM BLOĞU (950 A)

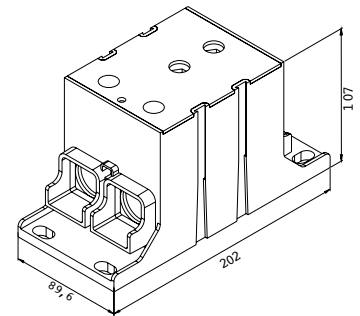
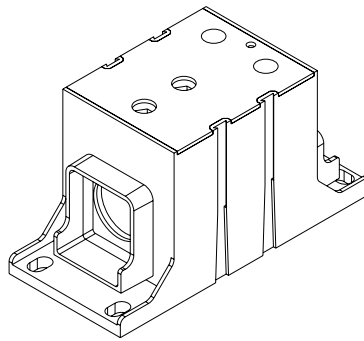

ÜRÜN KODU	CİNSİ	RENK	ADET (€)	KUTU ADEDİ
FTG-38650	950 A Giriş: 1 x 95 - 500 mm ² Çıkış: 2 x 50 - 300 mm ²	Gri	725,00 €	1
FTG-38650N		Mavi	725,00 €	1
FTG-38650PE		Yeşil	725,00 €	1
FTG-38650R		Kırmızı	725,00 €	1

PRATİK GÜÇ DAĞITIM BLOĞU

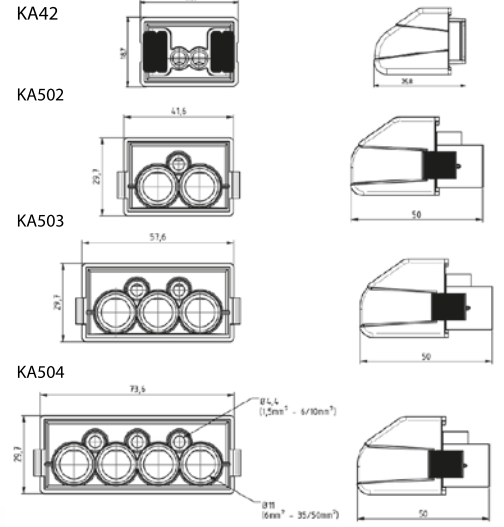

KA42



KA502



KA503N



KA504PE

ÜRÜN KODU	CİNSİ	ADET (€)	KUTU ADEDİ
FTG-KA42	690 V AC, 0,75 - 4 mm ² ,25A(Cu), 125A(AL)	7,75 €	1
FTG-KA502	1000 V DC, 690 V AC, 2 x 6-35 mm ² ,160A(Cu), 125A(AL)	10,80 €	1
FTG-KA502N	1000 V DC, 690 V AC, 2 x 6-35 mm ² ,160A(Cu), 125A(AL)	10,80 €	1
FTG-KA502PE	1000 V DC, 690 V AC, 2 x 6-35 mm ² ,160A(Cu), 125A(AL)	10,80 €	1
FTG-KA503	1000 V DC, 690 V AC, 3 x 6-35 mm ² ,160A(Cu), 125A(AL)	12,20 €	1
FTG-KA503N	1000 V DC, 690 V AC, 3 x 6-35 mm ² ,160A(Cu), 125A(AL)	12,20 €	1
FTG-KA503PE	1000 V DC, 690 V AC, 3 x 6-35 mm ² ,160A(Cu), 125A(AL)	12,20 €	1
FTG-KA504	1000 V DC, 690 V AC, 4 x 6-35 mm ² ,160A(Cu), 125A(AL)	21,00 €	1
FTG-KA504N	1000 V DC, 690 V AC, 4 x 6-35 mm ² ,160A(Cu), 125A(AL)	21,00 €	1
FTG-KA504PE	1000 V DC, 690 V AC, 4 x 6-35 mm ² ,160A(Cu), 125A(AL)	21,00 €	1

TAM İZOLELİ DAĞITICI ÜNİTELER (MÜHÜRLÜ KAPAK)

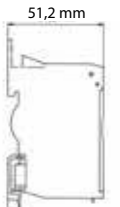
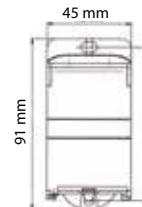

ÜRÜN KODU	CİNSİ	ADET (€)	KUTU ADEDİ
FTG-38814	Gri Renk, 250A, 1000 V DC , 690 V AC Giriş: 1 x 25 - 95 mm ² - 1 x 35 - 120 mm ² , Çıkış: 4 x 1.5 - 10 mm ² - 4 x 1.5 - 16 mm ²	42,50 €	1
FTG-38814N	Mavi Renk, 250A, 1000 V DC , 690 V AC Giriş: 1 x 25 - 95 mm ² - 1 x 35 - 120 mm ² , Çıkış: 4 x 1.5 - 10 mm ² - 4 x 1.5 - 16 mm ²	42,50 €	1
FTG-38814PE	Yeşil Renk, 250A, 1000 V DC , 690 V AC Giriş: 1 x 25 - 95 mm ² - 1 x 35 - 120 mm ² , Çıkış: 4 x 1.5 - 10 mm ² - 4 x 1.5 - 16 mm ²	42,50 €	1
FTG-38814R	Kırmızı Renk, 250A, 1000 V DC , 690 V AC Giriş: 1 x 25 - 95 mm ² - 1 x 35 - 120 mm ² , Çıkış: 4 x 1.5 - 10 mm ² - 4 x 1.5 - 16 mm ²	42,50 €	1

VİDA VE YAY BASKILI MODÜLER SİSTEM DAĞITICI ÜNİTE



ÜRÜN KODU	RENK	CİNSİ	GERİLİM / AKIM (V/A)	ADET (€)	KUTU ADEDİ
FTG-KS741	GRİ	2 x 25 mm ² - 14 x 4 mm ²	690V / 76A	10,50 €	10
FTG-KS741N	MAVİ	2 x 25 mm ² - 14 x 4 mm ²	690V / 76A	10,50 €	10
FTG-KS741PE	YEŞİL	2 x 25 mm ² - 14 x 4 mm ²	690V / 76A	10,50 €	10
FTG-KS741NPE	MAVİ/YEŞİL	1 x 16 mm ² - 7 x 4 mm ²	690V / 76A	10,50 €	10
FTG-KS741NN	MAVİ	1 x 16 mm ² - 7 x 4 mm ²	690V / 76A	10,50 €	10
FTG-KS741RN	KIRMIZI/MAVİ	1 x 16 mm ² - 7 x 4 mm ²	690V / 76A	10,50 €	10

TEK GİRİŞ TEK ÇIKIŞ DAĞITICI

BAKIR VE ALÜMİNYUM BAĞLANTIYA UYGUN!



ÜRÜN KODU	CİNSİ	GİRİŞ ÇIKIŞ	KABLO KESİTİ ARALIĞI	AKIM		ADET (€)	KUTU ADEDİ
				CU	AL		
FTG-KVIAC11150G	25 - 150 mm ² Gri	1/1	25 - 150 mm ²	315	250	28,00 €	20
FTG-KVIAC11150B	25 - 150 mm ² Mavi	1/1	25 - 150 mm ²	315	250	28,00 €	10
FTG-KVIAC11150YG	25 - 150 mm ² Sarı / Yeşil	1/1	25 - 150 mm ²	315	250	28,00 €	10
FTG-KVIAC11240G	35 - 240 mm ² Gri	1/1	35 - 240 mm ²	400	315	51,00 €	10
FTG-KVIAC11240B	35 - 240 mm ² Sarı / Mavi	1/1	35 - 240 mm ²	400	315	51,00 €	3
FTG-KVIAC11240YG	35 - 240 mm ² Sarı / Yeşil	1/1	35 - 240 mm ²	400	315	51,00 €	3

İKİ GİRİŞ İKİ ÇIKIŞ DAĞITICI



KVIAC12150B

ÜRÜN KODU	CİNSİ	GİRİŞ ÇIKIŞ	KABLO KESİTİ ARALIĞI	AKIM		ADET (€)	KUTU ADEDİ
				CU	AL		
FTG-KVIAC12035G	2.5 - 35 mm ² Gri	2 / 2	6 - 35 mm ²	2x125	100	24,00 €	30
FTG-KVIAC12035B	2.5 - 35 mm ² Mavi	2 / 2	6 - 35 mm ²	2x125	100	24,00 €	15
FTG-KVIAC12035YG	2.5 - 35 mm ² Sarı / Yeşil	2 / 2	6 - 35 mm ²	2x125	100	24,00 €	15
FTG-KVIAC12050G	2.5 - 50 mm ² Gri	2 / 2	2.5 - 50 mm ²	2x160	125	20,00 €	15
FTG-KVIAC12050B	2.5 - 50 mm ² Mavi	2 / 2	2.5 - 50 mm ²	2x160	125	20,00 €	15
FTG-KVIAC12050YG	2.5 - 50 mm ² Sarı / Yeşil	2 / 2	2.5 - 50 mm ²	2x160	125	20,00 €	15
FTG-KVIAC12095G	6 - 95 mm ² Gri	2 / 2	6 - 95 mm ²	2x250	200	34,00 €	30
FTG-KVIAC12095B	6 - 95 mm ² Mavi	2 / 2	6 - 95 mm ²	2x250	200	34,00 €	15
FTG-KVIAC12095YG	6 - 95 mm ² Sarı / Yeşil	2 / 2	6 - 95 mm ²	2x250	200	34,00 €	15
FTG-KVIAC12150G	2 x 25-150 mm ² Gri	2/2	25 - 150 mm ²	2x315	250	62,50 €	1
FTG-KVIAC12150B	25 - 150 mm ² Mavi	2 / 2	25 - 150 mm ²	2x315	250	62,50 €	5
FTG-KVIAC12150YG	25 - 150 mm ² Sarı / Yeşil	2 / 2	25 - 150 mm ²	2x315	250	62,50 €	5

İKİ GİRİŞ İKİ ÇIKIŞ ALTERNATİFLERİ



KVIAC12050YG

ÜRÜN KODU	CİNSİ	GİRİŞ ÇIKIŞ	KABLO KESİTİ ARALIĞI	AKIM		ADET (€)	KUTU ADEDİ
				CU	AL		
FTG-KVIAC12240G	2 Giriş, 2 Çıkış, 2 x 35 - 240 mm ² Gri	2/2	35 - 240 mm ²	2x400	315	98,00 €	1
FTG-KVIAC12240B	35 - 240 mm ² Mavi	2/2	35 - 240 mm ²	2x400	315	98,00 €	3
FTG-KVIAC12240YG	35 - 240 mm ² Sarı / Yeşil	2/2	35 - 240 mm ²	2x400	315	98,00 €	3

ÜÇ GİRİŞ ÜÇ ÇIKIŞ DAĞITICI



ÜRÜN KODU	CİNSİ	GİRİŞ ÇIKIŞ	KABLO KESİTİ ARALIĞI	AKIM		ADET (€)	KUTU ADEDİ
				CU	AL		
FTG-KVIAC31050G	2.5 - 50 mm ² Gri	3x1 / 3x1	2.5 - 50 mm ²	3x160	125	26,00 €	20

DiĞER GİRİŞ ÇIKIŞ ALTERNATİFLERİ



KVIAC51016G



KVIAC32035G

ÜRÜN KODU	CİNSİ	GİRİŞ ÇIKIŞ	KABLO KESİTİ ARALIĞI	AKIM		ADET (€)	KUTU ADEDİ
				CU	AL		
FTG-KVIAC14016G	2,5 - 16 mm ² Gri	4xFlexibel	2,5 - 16 mm ²	200	160	21,25 €	30
FTG-KVIAC14016B	2,5 - 16 mm ² Mavi	4xFlexibel	2,5 - 16 mm ²	200	160	22,50 €	15
FTG-KVIAC14016YG	2,5 - 16 mm ² Sarı / Yeşil	4xFlexibel	2,5 - 16 mm ²	200	160	22,50 €	15
FTG-KVIAC51016G	2,5 - 16 mm ² Gri	5x1 / 5x1	2,5 - 16 mm ²	5x80	63	34,00 €	10
FTG-KVIAC51016B	2,5 - 16 mm ² Mavi	5x1 / 5x1	2,5 - 16 mm ²	5x80	63	33,75 €	30
FTG-KVIAC51016YG	2,5 - 35 mm ² Yeşil	5x1 / 5x1	2,5 - 35 mm ²	5x80	63	33,75 €	30
FTG-KVIAC32035G	2,5 - 35 mm ² Gri	3x2 / 3x2	2,5 - 35 mm ²	3x2x160	125	51,25 €	1

TAM İZOLELİ DAĞITICI ÜNİTELER



ÜRÜN KODU	CİNSİ	ADET (€)	KUTU ADEDİ
FTG-38811	125A, GRİ Giriş : 2 x 10 - 35, Çıkış : 2 x 2,5 - 25,6 x 1,5 - 16	33,00 €	10
FTG-38811N	125A, MAVİ Giriş : 2 x 10 - 35, Çıkış : 2 x 2,5 - 25,6 x 1,5 - 16	33,00 €	5
FTG-38811PE	125A, YEŞİL Giriş : 2 x 10 - 35, Çıkış : 2 x 2,5 - 25,6 x 1,5 - 16	33,00 €	5
FTG-38811R	125A, KIRMIZI Giriş : 2 x 10 - 35, Çıkış : 2 x 2,5 - 25,6 x 1,5 - 16	33,00 €	6
FTG-38812	160A, GRİ Giriş : 2 x 25 - 70, Çıkış : 3 x 2,5 - 25, 8 x 1,5 - 16	36,50 €	3
FTG-38812N	160A, MAVİ Giriş : 2 x 25 - 70, Çıkış : 3 x 2,5 - 25, 8 x 1,5 - 16	36,50 €	3
FTG-38812PE	160A, YEŞİL Giriş : 2 x 25 - 70, Çıkış : 3 x 2,5 - 25, 8 x 1,5 - 16	36,50 €	30
FTG-38812R	160A, KIRMIZI Giriş : 2 x 25 - 70, Çıkış : 3 x 2,5 - 25, 8 x 1,5 - 16	36,50 €	15

KOMPLE İZOLELİ DAĞITICI ÜNİTELER

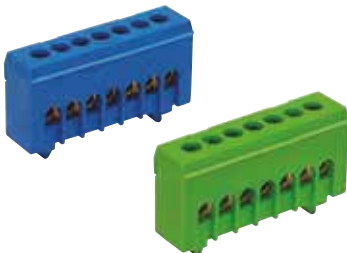

ÜRÜN KODU	CİNSİ	KABLO KESİTİ	ADET (€)	KUTU ADEDİ
FTG-870 N/7FS	7 x 16 mm ² Mavi	16 mm ²	3,10 €	10
FTG-870 S/7FS	7 x 16 mm ² Yeşil/Sarı	16 mm ²	3,10 €	10
FTG-870 N/15S	15 x 16 mm ² Mavi	16 mm ²	5,70 €	10
FTG-870 S/15S	15 x 16 mm ² Yeşil/Sarı	16 mm ²	5,70 €	10

GÜÇ DAĞITIM BLOKLARI ve GÜÇ KLEMENSLERİ

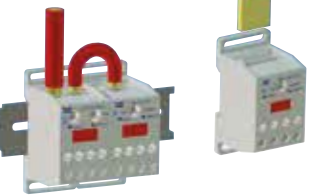

Renk Kodları

■ - Y	■ - B
■ - G	■ - YG
■ - R	■ - LG









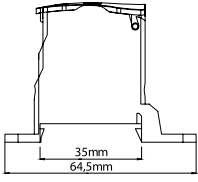
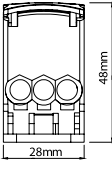

ÜRÜN KODU	CİNSİ	ADET (\$)	KUTU ADEDİ
XK2-35 / 10 x 4	125 A, Giriş 35 mm ² - Çıkış : 4 x 10 mm ²	15,56 \$	20
XK2-50 / 10 x 6	150 A, Giriş 50 mm ² - Çıkış : 6 x 10 mm ²	19,60 \$	12
XK2-50 / 16 x 4	150 A, Giriş 50 mm ² - Çıkış : 4 x 16 mm ²	19,60 \$	12
XK2-70 / 10 x 8	192 A, Giriş 70 mm ² - Çıkış : 8 x 10 mm ²	24,80 \$	10
XK2-70 x 2 / 10 x 8	192 A, Giriş 2 x 70 mm ² - Çıkış : 8 x 10 mm ²	29,40 \$	10
XK2-70 / 16 x 6	192 A, Giriş 70 mm ² - Çıkış : 6 x 16 mm ²	24,80 \$	10
XK2-95 / 25 x 4	232A, Giriş 95 mm ² - Çıkış : 4 x 25 mm ²	32,00 \$	10
XK2-120 / 16 x 8	232 A, Giriş 120 mm ² - Çıkış : 8 x 16 mm ²	47,36 \$	10

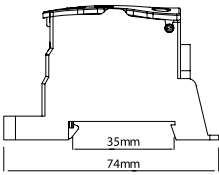
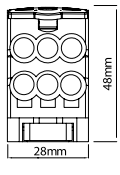

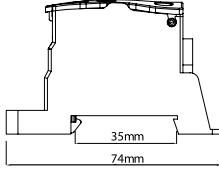
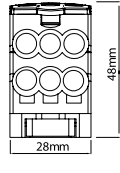
ÜRÜN KODU	CİNSİ	ADET (\$)	KUTU ADEDİ
XK2S-25/10x2+4x2	100 A, 25 mm ² Düz pin, Çıkış : 2 x 4 mm ² , 2 x 10 mm ²	9,24 \$	40
XK2S-35/10x2+4x2	125 A, 35 mm ² M6 delikli pin, Çıkış : 2 x 4 mm ² , 2 x 10 mm ²	9,24 \$	40
XK2S-35 / 4 x 9	125 A, 35 mm ² M6 delikli pin, Çıkış : 9 x 4 mm ²	10,52 \$	40
XK2S-70 / 16 x 4	192 A, 70 mm ² M8 delikli pin, Çıkış : 4 x 16 mm ²	12,60 \$	25

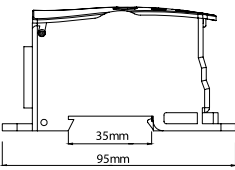
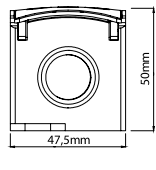
GÜÇ DAĞITIM BLOKLARI

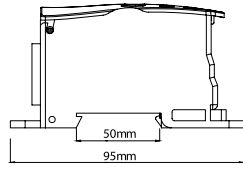
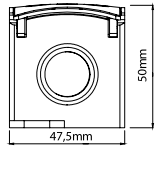

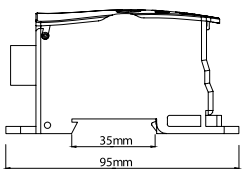
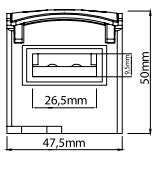
			ÜRÜN KODU	ÇİNSİ	ADET (\$)	KUTU ADEDİ
			ONK80	80 A Giriş: 3 x 6 - 16 mm ² Çıkış: 4 x 2,5 - 6 mm ² 3 x 2,5 - 16 mm ²	4,00 \$	1
			ÜRÜN KODU	ÇİNSİ	ADET (\$)	KUTU ADEDİ
			ONK125	125 A Giriş: 1 x 10 - 35 mm ² 1 x 2,5 - 16 mm ² Çıkış: 6 x 2,5 - 16 mm ²	8,50 \$	1
			ÜRÜN KODU	ÇİNSİ	ADET (\$)	KUTU ADEDİ
			ONK160	160 A Giriş: 1 x 10 - 70 mm ² 1 x 2,5 - 16 mm ² Çıkış: 6 x 2,5 - 16 mm ²	8,60 \$	1
			ÜRÜN KODU	ÇİNSİ	ADET (\$)	KUTU ADEDİ
			ONK250	250 A Giriş: 1 x 35 - 120 mm ² Çıkış: 2 x 6 - 35 mm ² 5 x 2,5 - 16 mm ² 4 x 2,5 - 10 mm ²	22,50 \$	1
			ÜRÜN KODU	ÇİNSİ	ADET (\$)	KUTU ADEDİ
			ONK400	400 A Giriş: 1 x 95 - 185 mm ² Çıkış: 2 x 6 - 35 mm ² 5 x 2,5 - 16 mm ² 4 x 2,5 - 10 mm ²	23,50 \$	1
			ÜRÜN KODU	ÇİNSİ	ADET (\$)	KUTU ADEDİ
			ONK500	500 A Bara Giriş: 9,3 x 26,4 mm Çıkış: 2 x 6 - 35 mm ² 5 x 2,5 - 16 mm ² 4 x 2,5 - 10 mm ²	25,00 \$	1

Onka®

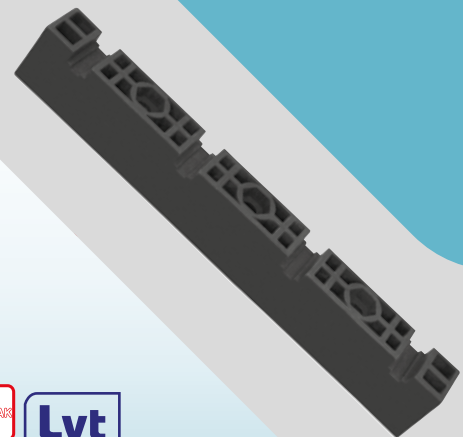
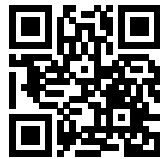
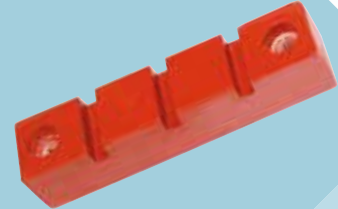

ÇİFT TARAF SAPLAMALI

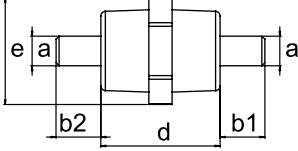

ÜRÜN KODU	TİP	ÖLÇÜLER					SERVİS V	TEST V	TENSİLE	KG	ADET (t)	KUTU ADEDİ
		a	b1	b2	e	d						
PLSM1001	1NO-S / M5	5	12	12	18	25,5	0,6	3	1,00	8,50	⚡	500
PLSM1002	1N1-S / M6	6	16	16	21	29,5	0,6	3	1,00	8,70		300
PLSM1003	1NMS-1 / M8	8	15	15	31,5	40	1	3	4,00	7,10		100
PLSM1004	1NMS-2 / M10	10	15	15	31,5	40	1	3	4,00	9,50		100
PLSM1013	1NMS-3 / M8	8	18	18	43,3	50	1	3	4,00	9,50		100
PLSM1014	1NMS-4 / M10	10	18	18	43,3	50	1	3	4,00	9,50		100

SAPLAMA & KÖR SOMUNLU

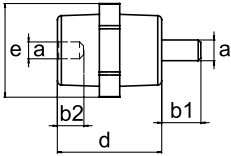

ÜRÜN KODU	TİP	ÖLÇÜLER					SERVİS V	TEST V	TENSİLE	KG	ADET (t)	KUTU ADEDİ
		a	b1	b2	e	d						
PLSM1005	1NO-K / M5	5	12	9	18	25,5	0,6	3	1,00	8,50	⚡	500
PLSM1006	1N1-K / M6	6	16	12	21	29,5	0,6	3	1,00	7,50		300
PLSM1007	1NMK-3 / M8	8	15,5	15	31,5	40	1	3	4,00	5,80		100
PLSM1008	1NMK2 / M10	10	15	15	31,5	40	1	3	4,00	7,70		100
PLSM1015	1NMK-5 / M8	8	18	15	43,3	50	1	3	4,00	7,70		100
PLSM1016	1NMK-6 / M10	10	18	15	43,3	50	1	3	4,00	7,70		100

ÇİFT TARAF KÖR SOMUNLU

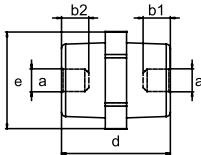

ÜRÜN KODU	TİP	ÖLÇÜLER					SERVİS V	TEST V	TENSİLE	KG	ADET (t)	KUTU ADEDİ
		a	b1	b2	e	d						
PLSM1009	1NO-KK / M5	5	9	9	18	25,5	0,6	3	1,00	7,50	⚡	500
PLSM1010	1N1-K K / M6	6	12	21	21	29,5	0,6	3	1,00	6,30		300
PLSM1011	1NMK-4 / M8	8	15	15	31,5	40	1	3	4,00	5,00		100
PLSM1012	1NMK-1 / M10	10	15	15	31,5	40	1	3	4,00	5,00		100
PLSM1017	1NMK-7 / M8	8	15	15	43,3	50	1	3	4,00	5,00		100
PLSM1018	1NMK-8 / M10	10	15	15	43,3	50	1	3	4,00	5,00		100

ÇİFT TARAF KÖR SOMUNLU

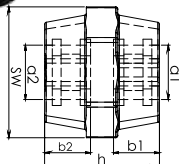
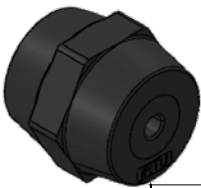

ÜRÜN KODU	TİP	ÖLÇÜLER						Voltaj kV	Test Voltaj	ADET (t)	KUTU ADEDİ
		a1	a2	b1	b2	sw	h				
PLMS303006	SW30 M6	M6	M6	11	11	30	30	1	3	⚡	100
PLMS303008	SW30 M8	M8	M8	11	11	30	30	1	3		100
PLMS303010	SW30 M10	M10	M10	11	11	30	30	1	3		100

PLASTİK (V0) TARAK İZOLATÖRLERİ

3x1F TARAK İZOLATÖR

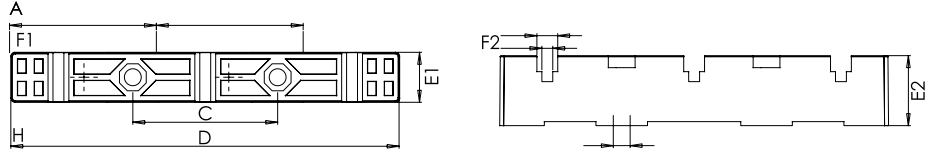

ÜRÜN KODU	TİP	ÖLÇÜLER									MIN	ADET (t)	KUTU ADEDİ
		A	C	D	E1	E2	F1	F2	H				
PLST1001	3X1F/5-10 mm	74	73	196	25	34,5	10,5	5,5	Ø8,5	5	50	50	

3x1F TARAK İZOLATÖR (4 TİJ)

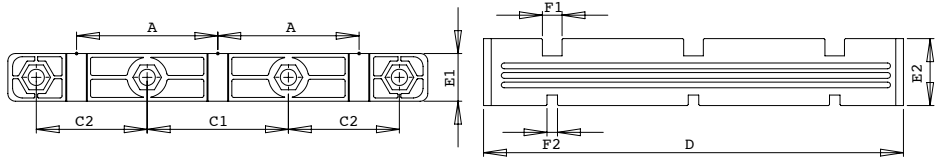
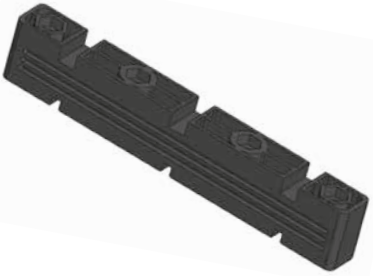

ÜRÜN KODU	TİP	ÖLÇÜLER									MIN	ADET (t)	KUTU ADEDİ
		A	C1	C2	D	E1	E2	F1	F2	H			
PLST1015	3X1F/5-10 mm	74	74	58,14	220	25	35	10,5	5,5	Ø8,5	5	50	

3x1F + N TARAK İZOLATÖR

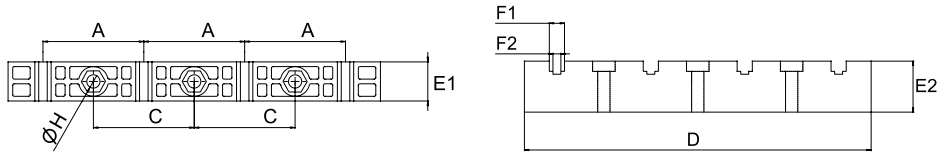

ÜRÜN KODU	TİP	ÖLÇÜLER									MIN	ADET (t)	KUTU ADEDİ
		A	C	D	E1	E2	F1	F2	H				
PLST1003	3X1F+N/5-10 mm	65	65	240	25,5	35,0	10,5	5,5	Ø9	5	50		

3x2F TARAK İZOLATÖR

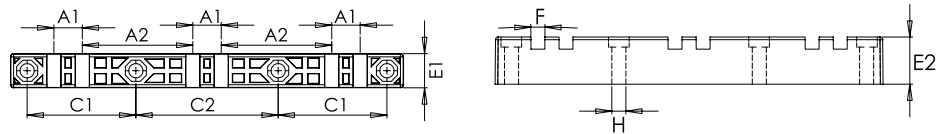

ÜRÜN KODU	TİP	ÖLÇÜLER									MIN	ADET (t)	KUTU ADEDİ
		A1	A2	C1	C2	D	E1	E2	F1	H			
PLST1002	3X2F/10 mm	20,5	81,3	80	105	290	25,0	34,5	10,5	Ø8,5	5	50	

PLASTİK (VO) TARAK İZOLATÖRLERİ

1X2F-1X3F 5-10 mm TARAK İZOLATÖR

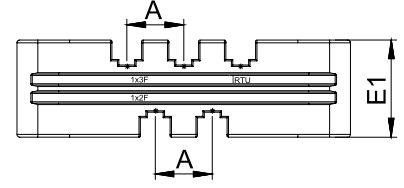
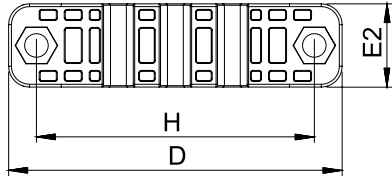

ÜRÜN KODU	TİP	ÖLÇÜLER					MIN	ADET (t)	KUTU ADEDİ
		A	D	H	E1	E2			
PLST1012	1x2F-1x3F/5-10 mm	20,5	120	100	35	30	5	100	100

1X4F-10 mm TARAK İZOLATÖR (ALTI DÜZ TİP)

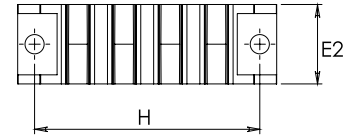
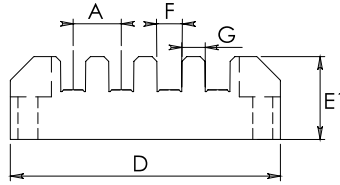

ÜRÜN KODU	TİP	ÖLÇÜLER							MIN	ADET (t)	KUTU ADEDİ
		A	D	F	H	E1	E2	G			
PLST1009	1x4F/10 mm	20,5	115,0	10,5	100,0	35,0	35,00	10,00	5	80	

GEÇİŞ İZOLATÖR

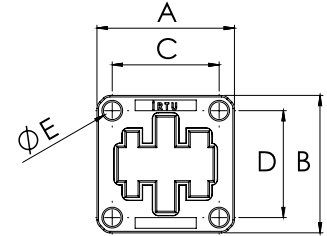

ÜRÜN KODU	TİP	ÖLÇÜLER					MIN	ADET (t)	KUTU ADEDİ
		A	D	C	D	E			
PLST1013	GEÇİŞ İZOLATÖRÜ 20x3 / 20x4 / 30x5 / 30x10	45,0	45,0	35,0	35,0	5,80	5	100	
PLST1014	GEÇİŞ İZOLATÖRÜ 25x5 / 20x10 / 40x10 / 50x10	60,00	60,00	45,00	45,00	6,50	5	100	

Bushings Properties

Bushings Material:	Glass Reinforced Polyamide 6.6
Conductor Temp:	140°C†
Flamability:	UL94-V0
Equipment Voltage U_e :	690V
Insulation Voltage U_i :	690V
Impulse Voltage U_{imp} :	8kV
Glow Wire:	960°C

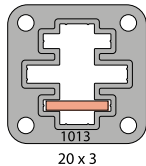

20 x 3

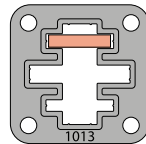

20 x 4

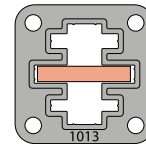

30 x 5

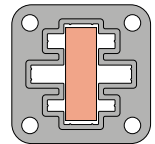

30 x 10

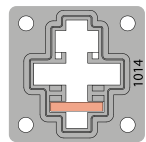

20 x 5

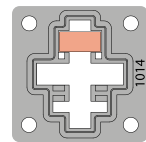

20 x 10

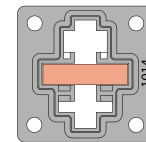

40 x 10

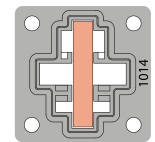

50 x 10

PROFİL BAĞLANTILI PLASTİK (VO) TARAK İZOLATÖRLERİ

1x3F 5 mm TARAK İZOLATÖR

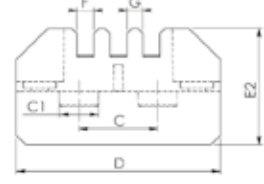
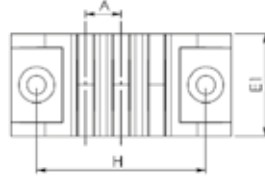

ÜRÜN KODU	TİP	ÖLÇÜLER										MIN	ADET (t)	KUTU ADEDİ
		A	C	C1	D	F	H	E1	E2	G				
PLST1011	1X3F/5 mm	10,5	25,0	8X12,4	65,0	5,5	50,0	30,0	37,0	5,0	5	100	100	

ÜRÜN KODU	TİP	KULLANILAN İZOLATÖR ADEDİ	KULLANILAN SAÇ PROFİL UZUNLUĞU	ADET (t)	KUTU ADEDİ
PLST1311	1X3F/5 mm 3 Faz Takım	6	430 mm	100	1
PLST1411	1X3F/5 mm 3 Faz +N Takım	8	600 mm	100	1

1x4F 5 mm TARAK İZOLATÖR

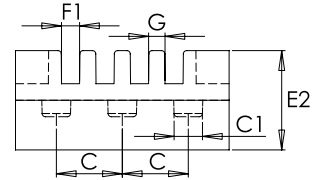
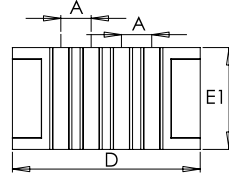

ÜRÜN KODU	TİP	ÖLÇÜLER									MIN (kN)	ADET (t)	KUTU ADEDİ
		A	C	C1	D	F1	E1	E2	G				
PLST1005	1X4F/5 mm	10,5	20,0	8,0	65,0	5,5	35,0	30,0	5,0	5	100	100	
PLST1020	1X4F/5 mm	15,5	25,0	12,40	90,0	5,5	24,9	37,0	10,0	-	100	100	

ÜRÜN KODU	TİP	KULLANILAN İZOLATÖR ADEDİ	KULLANILAN SAÇ PROFİL UZUNLUĞU	ADET (t)	KUTU ADEDİ
PLST1305	1X4F/5 mm 3 Faz Takım	6	430 mm	100	1
PLST1405	1X4F/5 mm 3 Faz +N Takım	8	600 mm	100	1

1x2F 10 mm TARAK İZOLATÖR

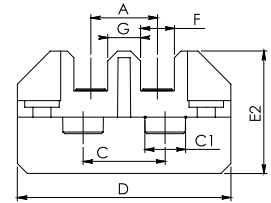
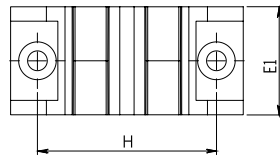

ÜRÜN KODU	TİP	ÖLÇÜLER										MIN	ADET (t)	KUTU ADEDİ
		A	C	C1	D	F	H	E1	E2	G				
PLST1007	1X2F/10 mm	20,5	25,0	8X12,4	65,0	10,5	50,0	30,0	37,0	10,0	5	100	100	

ÜRÜN KODU	TİP	KULLANILAN İZOLATÖR ADEDİ	KULLANILAN SAÇ PROFİL UZUNLUĞU	ADET (t)	KUTU ADEDİ
PLST1307	1X2F/10 mm 3 Faz Takım	6	430 mm	100	1
PLST1407	1X2F/10 mm 3 Faz +N Takım	8	600 mm	100	1

PROFİL BAĞLANTILI PLASTİK (VO) TARAK İZOLATÖRLERİ

1x3F 10 mm TARAK İZOLATÖR

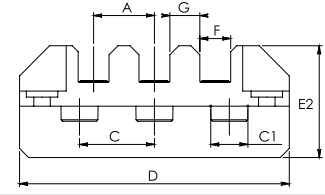
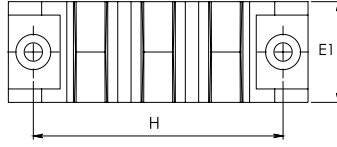

ÜRÜN KODU	TİP	ÖLÇÜLER									MIN	ADET (t)	KUTU ADEDİ
		A	C	C1	D	F	H	E1	E2	G			
PLST1008	1X3F/10 mm	20,5	20,0	8X12,4	90,0	10,5	75,0	30,0	37,0	10,0	5	100	100

ÜRÜN KODU	TİP	KULLANILAN İZOLATÖR ADEDİ	KULLANILAN SAÇ PROFİL UZUNLUĞU	ADET (t)	KUTU ADEDİ
PLST1308	1X3F/10 mm 3 Faz Takım	6	575 mm	100	1
PLST1408	1X3F/10 mm 3 Faz +N Takım	8	675 mm	100	1

1x4F 10 mm TARAK İZOLATÖR

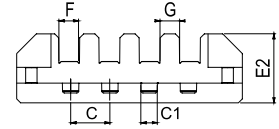
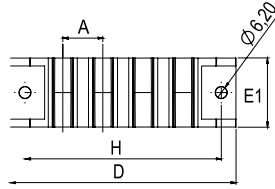

ÜRÜN KODU	TİP	ÖLÇÜLER									MIN	ADET (t)	KUTU ADEDİ
		A	C	C1	D	F	H	E1	E2	G			
PLST1006	1X4F/10 mm	20,5	20,0	8X12,4	115,0	10,5	100,0	35,0	35,0	10,0	5	100	100

ÜRÜN KODU	TİP	KULLANILAN İZOLATÖR ADEDİ	KULLANILAN SAÇ PROFİL UZUNLUĞU	ADET (t)	KUTU ADEDİ
PLST1306	1X4F/10 mm 3 Faz Takım	6	575 mm	100	1
PLST1406	1X4F/10 mm 3 Faz +N Takım	8	675 mm	100	1

1x3F 10 mm TARAK İZOLATÖR

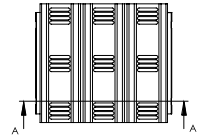
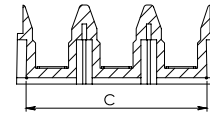
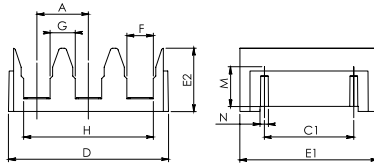

ÜRÜN KODU	TİP	ÖLÇÜLER											MIN	ADET (t)	KUTU ADEDİ
		A	D	F	H	E1	E2	G	C	C1	N	M			
PLST1010	1X3F/10 mm	21,0	69,6	10,5	51,5	55,0	25,0	10,0	63,0	35,5	3,35	15,7	5	100	100

ÜRÜN KODU	TİP	KULLANILAN İZOLATÖR ADEDİ	KULLANILAN SAÇ PROFİL UZUNLUĞU	ADET (t)	KUTU ADEDİ
PLST1310	1X3F/10 mm 3 Faz Takım	6	575 mm	100	1
PLST1410	1X3F/10 mm 3 Faz +N Takım	8	675 mm	100	1

DAHİLİ TİP A.G. MESNET İZOLATÖR (Polyester)

ÇİFT TARAF SAPLAMALI

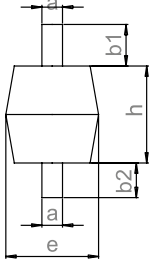

ÜRÜN KODU	TİP	ÖLÇÜLER					Service	Test	Tensile	Ağırlık kg	ADET (t)	KUTU ADEDİ
		a1	b1	b2	e	h						
POLM1001	1NO-S/M5	5	12	12	22	24	0,6	3	0,75	11,00	☎	500
POLM1002	1N1-S/M6	6	15	15	27	28	0,6	3	1,00	12,00		300
POLM1003	1NMS-1/M8	8	16	19	40	40	1	3	2,50	10,50		100
POLM1004	1NMS-2/M10	10	12	15	40	40	1	3	2,70	14,00		100

SAPLAMA & KÖR SOMUNLU

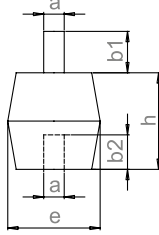

ÜRÜN KODU	TİP	ÖLÇÜLER					Service	Test	Tensile	Ağırlık kg	ADET (t)	KUTU ADEDİ
		a1	b1	b2	e	h						
POLM1005	1NO-K/M5	5	12	12	22	24	0,6	3	0,75	10,50	☎	500
POLM1006	1N1-K/M6	6	15	15	27	28	0,6	3	1,00	10,80		300
POLM1007	1NMK-3/M8	8	16	15	40	40	1	3	2,50	9,80		100
POLM1008	1NMK-2/M10	10	15	15	40	40	1	3	2,70	11,40		100

ÇİFT TARAF KÖR SOMUNLU

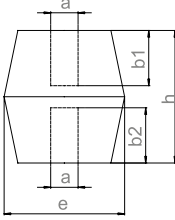

ÜRÜN KODU	TİP	ÖLÇÜLER					Service	Test	Tensile	Ağırlık kg	ADET (t)	KUTU ADEDİ
		a1	b1	b2	e	h						
POLM1009	1NO-KK/M5	5	9	9	22	24	0,6	3	0,75	10,00	☎	500
POLM1010	1N1-KK/M6	6	12	12	27	28	0,6	3	1,00	9,90		300
POLM1011	1NMK-4/M8	8	15	15	40	40	1	3	2,50	8,80		100
POLM1012	1NMK-1/M10	10	15	15	40	40	1	3	2,70	8,90		100

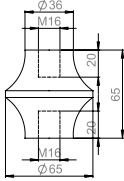

ÜRÜN KODU	TİP	Service	Test	Tensile	Ağırlık kg	ADET (t)	KUTU ADEDİ
POLM1015	1NMC-3	3	15	5,00	4,60	☎	18

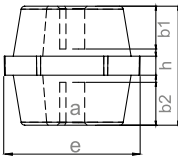

ÜRÜN KODU	TİP	ÖLÇÜLER					Service	Test	Tensile	Ağırlık kg	ADET (t)	KUTU ADEDİ
		a1	b1	b2	e	h						
POLM1019	1NMK-5/M8	8	15	15	50	50	1	3	9	20,00	☎	100
POLM1020	1NMK-6/M10	10	15	15	50	50	1	3	9	21,00		100
POLM1021	1NMK-7/M12	12	15	15	50	50	1	3	10	22,00		100

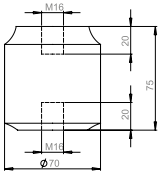

ÜRÜN KODU	TİP	Service	Test	Tensile	Ağırlık kg	ADET (t)	KUTU ADEDİ
POLM1013	1NMD-1	3	20	6,00	9,00	☎	18

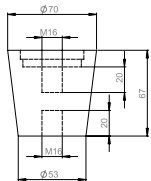

ÜRÜN KODU	TİP	Service	Test	Tensile	Ağırlık kg	ADET (t)	KUTU ADEDİ
POLM1014	1NMA-2	3	15	5,5	6,65	☎	18

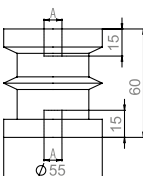

ÜRÜN KODU	TİP	Service	Test	Tensile	Ağırlık kg	ADET (t)	KUTU ADEDİ
POLM1016	1N500	M8	3	15	5,00	☎	32
POLM1017	1N500	M10	3	15	5,00		32
POLM1018	1N500	M12	3	15	5,00		32

DAHİLİ TİP A.G. TARAK İZOLATÖR (Polyester)

3x1F TARAK İZOLATÖR

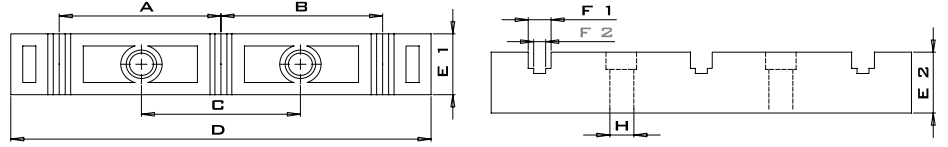

ÜRÜN KODU	TİP	ÖLÇÜLER									Min kN	ADET (t)	KUTU ADEDİ
		A	B	C	D	E1	E2	F1	F2	H			
POLT1002	3x1F/5-10 mm	74,5	74,5	73	193	30	30	10,5	5,5	Ø11	5	☎	40

3x1F TARAK İZOLATÖR

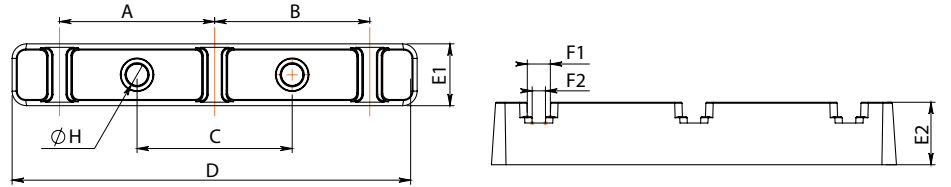

ÜRÜN KODU	TİP	ÖLÇÜLER									Min kN	ADET (t)	KUTU ADEDİ
		A	B	C	D	E1	E2	F1	F2	H			
POLT1012	3x1F/5-10 mm	74	74	74	193	30	30	6	11	Ø9,5	5	☎	40

3x2F TARAK İZOLATÖR

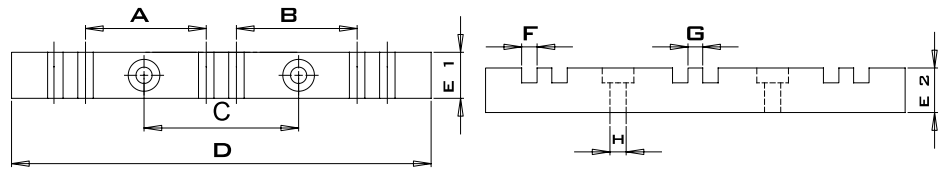

ÜRÜN KODU	TİP	ÖLÇÜLER									Min kN	ADET (t)	KUTU ADEDİ
		A	B	C	D	E1	E2	F1	F2	H			
POLT1007	3x2F/10 mm	82	82	105	285	31	30	10,5	10	Ø11	5	☎	50
POLT1008	3x2F/5 mm	91,5	91,5	105	285	31	30	5,5	5	Ø11	5		50

3x1F + N TARAK İZOLATÖR

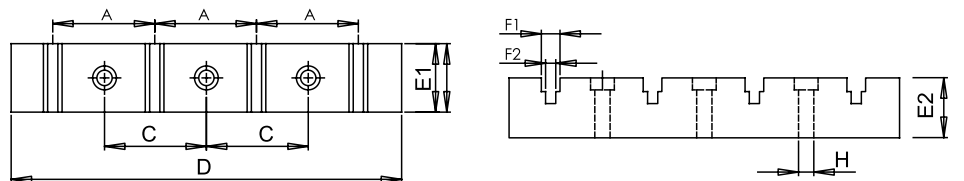

ÜRÜN KODU	TİP	ÖLÇÜLER								Min kN	ADET (t)	KUTU ADEDİ
		A	C	D	E1	E2	F1	F2	H			
POLT1005	3x1F+N/5-10 mm	60	60	230	40	34,5	10,5	5,5	Ø9	5	☎	32

DAHİLİ TİP A.G. TARAK İZOLATÖR (Polyester)

3x1F+N TARAK İZOLATÖR

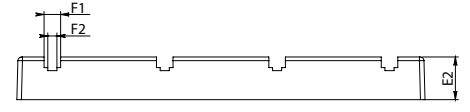
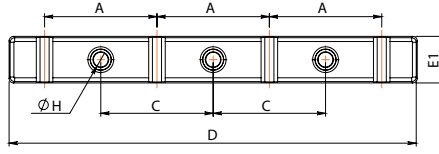

ÜRÜN KODU	TİP	ÖLÇÜLER								Min kN	ADET (t)	KUTU ADEDİ
		A	C	D	E1	E2	F1	F2	H			
POLT1013	3x1F+N/5-10 mm	74	74	269	30	28	11	6	Ø9,5	5	50	

1x4F TARAK İZOLATÖR

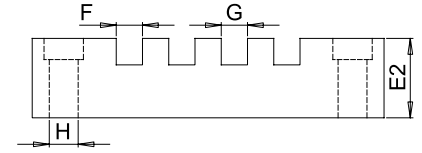
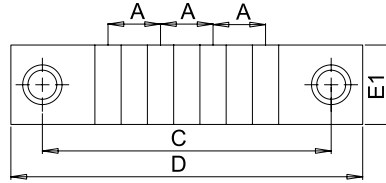

ÜRÜN KODU	TİP	ÖLÇÜLER								Min kN	ADET (t)	KUTU ADEDİ
		A	C	D	E1	E2	F1	F2	H			
POLT1004	1x4F/5 mm	22	110	134	31	29	5,5	10,5	Ø9	5	50	
POLT1001	1x4F/10 mm	22	110	134	31	29	10,5	10,5	Ø9	5	50	

3x1FK TARAK İZOLATÖR

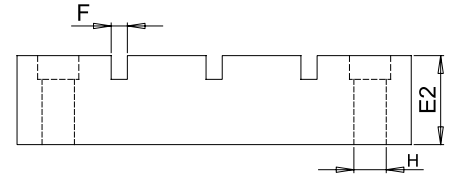
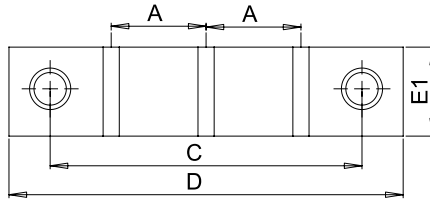

ÜRÜN KODU	TİP	ÖLÇÜLER								Min kN	ADET (t)	KUTU ADEDİ
		A	C	D	E1	E2	F1	F2	H			
POLT1003	3x1FK/5 mm Bakır	33	110	134	31	29	5,5	27	Ø9	5	50	

3x2F + N TARAK İZOLATÖR

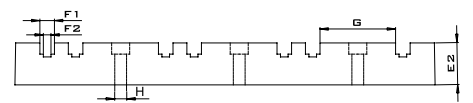
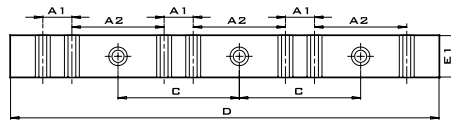

ÜRÜN KODU	TİP	ÖLÇÜLER								Min kN	ADET (t)	KUTU ADEDİ
		A1	A2	C	D	E1	E2	F1/F2	G			
POLT1009	3x2F+N/5-10 mm	20,5	65	85,5	303	31	30	10,5/5,5	54,5	Ø8,5	5	50

DAHİLİ TİP A.G. TARAK İZOLATÖR (Polyester)

3x3F TARAK İZOLATÖR

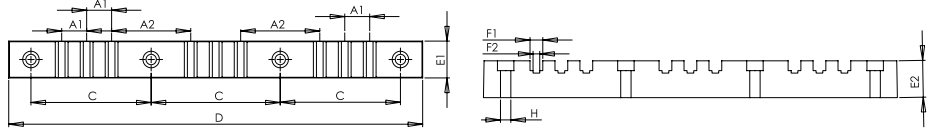

ÜRÜN KODU	TİP	ÖLÇÜLER											Min kN	ADET (t)	KUTU ADEĐİ
		A1	A2	C1	C2	D	E1	E2	F1	F2	G	H			
POLT1010	3x3F/5-10 mm	20,5	65	98,75	106	340	30	30	10,5	5,5	10	Ø8,5	5	☎	20

3x1FY+N TARAK İZOLATÖR

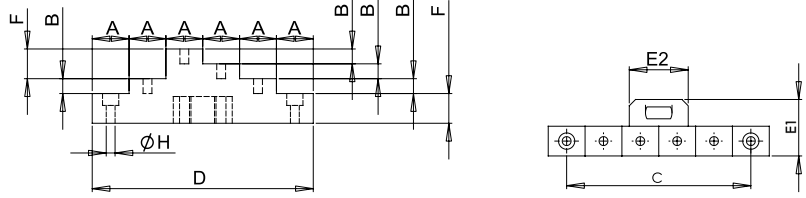

ÜRÜN KODU	TİP	ÖLÇÜLER								Min kN	ADET (t)	KUTU ADEĐİ
		A	B	C	D	E1	E2	F	H			
POLT1006	3x1FY + N	25	10	125	150	38	40	20	Ø6	5	☎	26

BARA TUTUCU SERFİL



ÜRÜN KODU	CİNSİ	ADET (t)	KUTU ADEĐİ
EMTİ-M8-M10	SERFİL	☎	100

EŞ POTANSİYEL BARA



ÜRÜN KODU	CİNSİ	ADET (t)	KUTU ADEĐİ
İR-303250	30 x 3 25 cm 7 Delik	☎	1
İR-303300	30 x 3 30 cm 10 Delik		1
İR-305300	30 x 5 30 cm 7 Delik		1
İR-305400	30 x 5 40 cm 9 Delik		1
İR-305500	30 x 5 50 cm 12 Delik		1

ASKI APARATI



ÜRÜN KODU	AÇIKLAMA	ADET (t)	KUTU ADEDİ
İR-7001	80'lik Kablo Taşıma Askısı	1	50

SIEMENS KÖRÜK



ÜRÜN KODU	AÇIKLAMA	ADET (t)	KUTU ADEDİ
İRPKT-1050	Gırtlaklı Körük / 180 x 64 Siemens	1	60

* Orta gerilim hücre içinde kablo girişlerinde sızdırmalara karşı kullanılır.

ORTA GERİLİM HÜCRE KABLO KÖRÜĞÜ



ÜRÜN KODU	AÇIKLAMA	ADET (t)	KUTU ADEDİ
İRPKT-1040	Ø60 Plastik Kablo Tutucu	1	100
İRPKT-1030	Ø100 Plastik Kablo Tutucu	1	120

ORTA GERİLİM HÜCRE KABLO TUTUCU



* Orta gerilim hücre içinde kablo girişlerinde kullanılır.
* Yanmaz ve halogen-free özelliğindedir.
* Ø 50-80 mm kabloya uygundur.

ÜRÜN KODU	AÇIKLAMA	ADET (t)	KUTU ADEDİ
İRPKT-1020	PLASTİK KABLO TUTUCU	1	100

TIRNAKLI KROŞELER (PLASTİK)

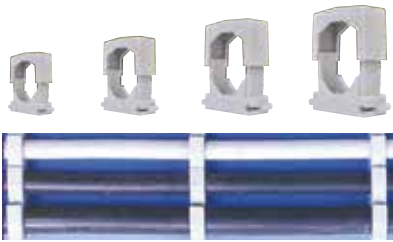

ÜRÜN KODU	AÇIKLAMA	ADET (t)	KUTU ADEDİ
İR-5155	No. 1 Tırnaklı Kroşe 2 x 1.5 / 2 x 2.5 / 2 x 4 / 2 x 6 / 3 x 1.5 / 4 x 1.5 / 3 x 2.5 / 4 x 2.5	1	100
İR-5156	No. 2 Tırnaklı Kroşe 4 x 4 / 4 x 6	1	100
İR-5157	No. 3 Tırnaklı Kroşe 4 x 10 NYM / 3 x 16 + 10 NYY	1	100
İR-5158	No. 4 Tırnaklı Kroşe 3 x 25 + 16 / 3 x 35 + 16 / 3 x 50 + 25 NYY	1	25

BORU / KABLO SABİTLEYİCİLER ve BAĞLANTI RAYLARI



ÜRÜN KODU	AÇIKLAMA	ADET (t)	KUTU ADEDİ
İR-9001	BORU VE KABLO SABİTLEYİCİSİ (8-36)	1	750
İR-9002	BORU VE KABLO SABİTLEYİCİSİ (14-48)	1	250
İR-9003	BORU VE KABLO SABİTLEYİCİSİ (24-72)	1	250

BORU / KABLO BAĞLANTI RAYLARI



ÜRÜN KODU	AÇIKLAMA	ADET (t)	KUTU ADEDİ
İRMR-9001	GALVANİZ RAY (8-36) (2 mt)	1	100
İRMR-9002	GALVANİZ RAY (14-48 / 24-72) (2 mt)	1	100

UPGM 203 CAM ELYAF PLAKALAR



ÜRÜN KODU	AÇIKLAMA	ÖLÇÜLER (mm)			ADET (t)
		Kalınlık	En	Boy	
İRCEP038001200	Cam Elyaf Polyester Plaka	3	800	1200	☎
İRCEP058001200		5	800	1200	
İRCEP108001200		10	800	1200	
İRCEP158001000		15	800	1200	
İRCEP208001200		20	800	1200	
İRCEP258001200		25	800	1200	
İRCEP308001200		30	800	1200	
İRCEP308001200		30	800	1200	
İRCET030301200	Cam Elyaf Polyester Takoz	3	30	1200	☎
İRCET030401200		3	40	1200	
İRCET030501200		3	50	1200	
İRCET030601200		3	60	1200	
İRCET050301200	Cam Elyaf Polyester Takoz	5	30	1200	☎
İRCET050401200		5	40	1200	
İRCET050501200		5	50	1200	
İRCET050601200		5	60	1200	
İRCET100301200	Cam Elyaf Polyester Takoz	10	30	1200	☎
İRCET100401200		10	40	1200	
İRCET100501200		10	50	1200	
İRCET100601200		10	60	1200	
İRCET150301200	Cam Elyaf Polyester Takoz	15	30	1200	☎
İRCET150401200		15	40	1200	
İRCET150501200		15	50	1200	
İRCET150601200		15	60	1200	
İRCET200301200	Cam Elyaf Polyester Takoz	20	30	1200	☎
İRCET200401200		20	40	1200	
İRCET200501200		20	50	1200	
İRCET200601200		20	60	1200	
İRCET250301200	Cam Elyaf Polyester Takoz	25	30	1200	☎
İRCET250401200		25	40	1200	
İRCET250501200		25	50	1200	
İRCET250601200		25	60	1200	
İRCET300301200	Cam Elyaf Polyester Takoz	30	30	1200	☎
İRCET300401200		30	40	1200	
İRCET300501200		30	50	1200	
İRCET300601200		30	60	1200	



Birim fiyatlara civata ve somun dahildir.
TEDAŞ / TEİAŞ standartlarına uygundur.

OG ANTİSTATİK KABLO KROŞESİ

MODEL	AÇIKLAMA	ADET ()
TİP-1P/1-2-3-4-5-6-7	XLPE Kablo Kroşesi - Polyamid - 36KV 1x35/16 mm ² 1x150/16 mm ² XLPE Kablo için Min Çap : 32 mm - Max Çap : 38 mm	
TİP-2P/1-2-3-4-5-6	XLPE Kablo Kroşesi - Polyamid - 36KV 1x150/16 mm ² 1x400/35 mm ² XLPE Kablo için Min Çap : 38 mm - Max Çap : 47 mm	
TİP-3P/1-2-3-4-5	XLPE Kablo Kroşesi - Polyamid - 36KV 1x500/35 mm ² 1x630/35 mm ² XLPE Kablo için Min Çap : 52 mm - Max Çap : 68 mm	
TİP-1HF/1-2-3-4-5-6-7	XLPE Kablo Kroşesi - Polyamid HF / UV - 36KV 1x35/16 mm ² 1x150/ 16 mm ² XLPE Kablo için Min Çap : 32 mm - Max Çap : 38 mm	
TİP-2HF/ 1-2-3-4-5-6-7	XLPE Kablo Kroşesi - Polyamid HF / UV - 36KV 1x150/16 mm ² 1x400/35 mm ² XLPE Kablo için Min Çap : 38 mm - Max Çap : 47 mm	
TİP-3HF/1-2-3-4-5	XLPE Kablo Kroşesi - Polyamid HF / UV - 36KV 1x500/35 mm ² 1x630/35 mm ² XLPE Kablo için Min Çap : 52 mm - Max Çap : 68 mm	



KOLLU PANO KİLİDİ İSPANYOLET MEKANİZMALI

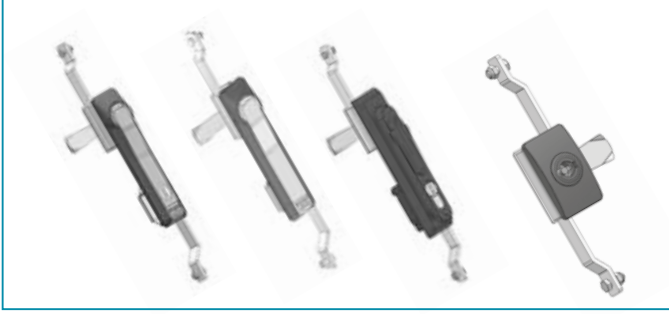

KABİN KİLİTLERİ



PANO KİLİTLERİ



YAYLI PANO KİLİTLERİ



ÇEKMECE KİLİTLERİ



KÜP MENTEŞELER



PANO KAPAK MENTEŞELERİ VE YAPRAK MENTEŞELER



AL.VE PLAST. GEÇMELİ KABİN TOZ FIRÇALARI



PANO VİDA VE SOMUNLARI



POLİETİLEN VE EPDM CONTALAR

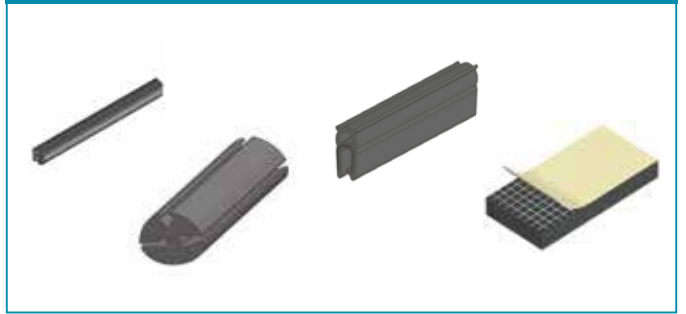

Onka®

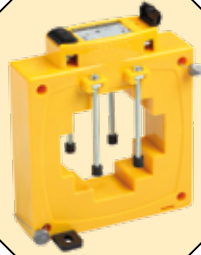

Sezgin®

HAWCON
KONDANSATÖR



NEOZED BUŞON / SİGORTA YUVALARI



AÇMA KAPAMA ŞALTERLERİ



HIZLI SİGORTALAR



KADEMELİ ŞALTERLER



PORSELEN SİGORTALAR



KUTUP DEĞİŞTİRİCİ ŞALTERLER



SOLAR SİGORTA BUŞONU / NORMAL BUŞON



AYIRICI KESİCİ ŞALTERLER



NH SİGORTALAR / NH ALTLIK



MOTOR KUMANDA ŞALT. - ÖLÇME KOMİTATÖRLERİ





3 KUTUPLU KONTAKTÖR - KUMANDA 230 V AC



ÜRÜN KODU	GÜÇ / AKIM / Y.KONTAK	ADET (\$)
XCN-35091	4 kW, 9 A, 1NO	8,00 \$
XCN-35092	4 kW, 9 A, 1NC	8,00 \$
XCN-35121	5.5 kW, 12 A, 1NO	8,20 \$
XCN-35122	5.5 kW, 12 A, 1NC	8,20 \$
XCN-35181	7.5 kW, 18 A, 1NO	9,80 \$
XCN-35182	7.5 kW, 18 A, 1NC	9,80 \$
XCN-35251	11 kW, 25 A, 1NO	13,00 \$
XCN-35252	11 kW, 25 A, 1NC	13,00 \$
XCN-35321	15 kW, 32 A, 1NO	18,40 \$
XCN-35322	15 kW, 32 A, 1NC	18,40 \$
XCN-35405	18.5 kW, 40 A, 1NO + 1NC	33,40 \$
XCN-35505	22 kW, 50 A, 1NO + 1NC	36,80 \$
XCN-35655	30 kW, 65 A, 1NO + 1NC	39,40 \$
XCN-35805	37 kW, 80 A, 1NO + 1NC	51,40 \$
XCN-35955	45 kW, 95 A, 1NO + 1NC	57,40 \$
XCN-35965	55 kW, 115 A, 1NO + 1NC	115,00 \$
XCN-35975	75 kW, 150 A, 1NO + 1NC	125,00 \$

MOTOR KORUMA ŞALTERİ



ÜRÜN KODU	AKIM / GÜÇ	ADET (\$)
15 kA		
XMP-10010	0.63 - 1 A, 0.25 kW	20,00 \$
XMP-10016	1 - 1.6 A, 0.55 kW	20,00 \$
XMP-10025	1.6 - 2.5 A, 0.75 kW	20,00 \$
XMP-10040	2.5 - 4A, 1.5 kW	20,00 \$
XMP-10063	4 - 6.3 A, 2.2 kW	20,00 \$
XMP-10100	6 - 10 A, 4 kW	20,00 \$
XMP-10140	9 - 14A, 5.5 kW	20,00 \$
XMP-10180	13 - 18 A, 7.5 kW	20,00 \$
XMP-10230	17 - 23 A, 9 kW	20,00 \$
XMP-10250	20 - 25 A, 11 kW	20,00 \$
XMP-10320	24 - 32 A, 15 kW	20,00 \$

Yardımcı Donanım

XMP-90211	Üst Kontak, NO + NC	3,50 \$
XMP-91211	Yan Kontak, NO + NC	4,80 \$

YARDIMCI KONTAK BLOĞU



ÜRÜN KODU	MONTAJ / KONTAK	ADET (\$)
XCN-39211	Üst, 1NO + 1NC	2,40 \$
XCN-39422	Üst, 2NO + 2NC	3,90 \$



KAÇAK AKIM KORUMA RÖLESİ

3 KUTUPLU MİNİ KONTAKTÖR



ÜRÜN KODU	GÜÇ / AKIM / Y.KONTAK	ADET (\$)
XCN-15091	230 V AC, 4 kW, 9 A, 1NO	8,00 \$
XCN-15092	230 V AC, 4 kW, 9 A, 1NC	8,00 \$
XCN-17091	24 V AC, 4 kW, 9 A, 1NO	9,50 \$
XCN-17092	24 V AC, 4 kW, 9 A, 1NC	9,50 \$

TERMİK RÖLE



ÜRÜN KODU	GÜÇ / AKIM / Y.KONTAK	ADET (\$)
Kontaktörü: 9-32A		
XTR-31010	0.63 - 1 A	8,10 \$
XTR-31016	1 - 1.6 A	8,10 \$
XTR-31025	1.6 - 2.5 A	8,10 \$
XTR-31040	2.5 - 4 A	8,10 \$
XTR-31060	4 - 6 A	8,10 \$
XTR-31080	5.5 - 8 A	8,10 \$
XTR-31100	7 - 10 A	8,10 \$
XTR-31130	9 - 13 A	8,10 \$
XTR-31180	12 - 18 A	8,10 \$
XTR-31250	17 - 25 A	8,10 \$



ÜRÜN KODU	AKIM / GÜÇ	ADET (\$)
2 Kutuplu		
XLC-41225	2 x 25A, 30 mA	13,00 \$
XLC-41240	2 x 40A, 30 mA	13,20 \$
XLC-41263	2 x 63A, 30 mA	13,50 \$
XLC-42225	2 x 25A, 300 mA	13,00 \$
XLC-42240	2 x 40A, 300 mA	13,20 \$
XLC-42263	2 x 63A, 300 mA	13,50 \$
4 Kutuplu		
XLC-41425	4 x 25 A, 30 mA	18,00 \$
XLC-41440	4 x 40 A, 30 mA	18,50 \$
XLC-41463	4 x 63 A, 30 mA	19,00 \$
XLC-42425	4 x 25 A, 300 mA	18,00 \$
XLC-42440	4 x 40 A, 300 mA	18,50 \$
XLC-42463	4 x 63 A, 300 mA	19,00 \$

FAZ KORUMA RÖLESİ



ÜRÜN KODU	AÇIKLAMA	ADET (\$)
RT8-MP110	Faz Sıralı, %20 SBT	9,50 \$
RT8-MP130	Faz Sıralı, PTC'li	12,30 \$

ZAMAN RÖLESİ



ÜRÜN KODU	AÇIKLAMA	ADET (\$)
RT8-TS130	0-30 Sn.	10,00 \$
RT8-TS160	0-60 Sn.	10,20 \$
RT8-TS410	0-100 Saat Multi	12,50 \$

YILDIZ / ÜÇGEN YOL VERME RÖLESİ



ÜRÜN KODU	AÇIKLAMA	ADET (\$)
RT8-TD110	Çift Ayarlı NO+NC	14,90 \$

FOTOSEL RÖLESİ



ÜRÜN KODU	AÇIKLAMA	ADET (\$)
RT8-PL101	Lüks Ayarlı / Röle Çıkışı	12,10 \$
RT8-PL900	Fotosel Göz	5,20 \$

SIVI SEVİYE RÖLESİ



ÜRÜN KODU	AÇIKLAMA	ADET (\$)
RT8-LC110	Hassasiyet Ayarlı 0-50 kOhm	15,85 \$
RT8-LC900	Sıvı Seviye Elektrodu	2,70 \$

SLIM SICAKLIK KONTROL RÖLESİ



ÜRÜN KODU	AÇIKLAMA	ADET (\$)
STC-1000	Slim Sıcaklık Kontrol	

POTANSİYOMETRE



ÜRÜN KODU	AÇIKLAMA	ADET (\$)
Ø22 Tek Tur Potansiyometre		
MPT-21001	1 kOhm	4,80 \$
MPT-21002	2.2 kOhm	4,80 \$
MPT-21005	5 kOhm	4,80 \$
MPT-21010	10 kOhm	4,80 \$

SAYICI



ÜRÜN KODU	AÇIKLAMA	ADET (\$)
Mekanik Sayıcı-Resetli-Kilitli, Montaj: 48x24mm		
MCN-11605	220 VAC / 6 Hane	20,00 \$
MCN-11607	24 VDC / 6 Hane	20,00 \$



ÜRÜN KODU	AÇIKLAMA	ADET (\$)
Mekanik Sayıcı-Resetli-Kilitli, Montaj: 48x24mm		
MCN-12605	220VAC / 6 Hane	20,00 \$
MCN-12607	24 VDC / 6 Hane	20,00 \$



ÜRÜN KODU	AÇIKLAMA	ADET (\$)
Dijital Sayıcı-Resetli, Montaj: 48x24mm		
MCN-22605	220VAC / 6 Hane	28,00 \$
MCN-22607	24 VDC / 6 Hane	28,00 \$



ÜRÜN KODU	AÇIKLAMA	ADET (\$)
İş Güç Zaman Saati, 48x48mm		
MCN-48825	220VAC / 7 Hane	10,00 \$

AYAK PEDALI



ÜRÜN KODU	GÖVDE / BOYUT	ADET (\$)
Tek Kademeli Pedal, 2m Kablolu (Kontak: CO, 10A/250 V AC)		
MPD-15050	Plastik / 100x62x32 mm	5,60 \$
MPD-15090	Plastik / 100x62x32 mm	6,20 \$
MPD-15100	Sac / 100x70x33 mm	6,00 \$
MPD-15200	Döküm / 135x65x45 mm	6,40 \$
MPD-15300	Döküm / 165x80x55 mm	8,00 \$

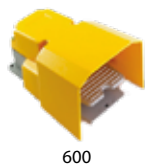

ÜRÜN KODU	GÖVDE / BOYUT	ADET (\$)
Korunmalı Pedal, Tek Kademe (Kontak: CO)		
MPD-15400	Döküm / 200x100x130 mm	22,00 \$
MPD-15600	Döküm / 210x150x125 mm	28,00 \$



LİMİT SWITCH



ÜRÜN KODU	AÇIKLAMA	ADET (\$)
MLP Plastik Gövde (Kontak: NO+NC, 3A/240 V AC, Snap Action)		
MLP-25110	Dikey Pim Kısa	4,20 \$
MLP-25112	Dikey Pim Makara, Ø12 mm, Metal	4,20 \$
MLP-25121	Dikey Pim Düz Kol Mak. Ø12 mm, Metal	4,20 \$
MLP-25129	Dikey Pim, Test Kol, Mak. Ø12 mm, Metal	4,20 \$
MLP-25131	Döner Sabit Kol, Mak. Ø18 mm, Plastik	4,20 \$
MLP-25132	Döner Sabit Kol, Mak. Ø18 mm, Metal	4,20 \$
MLP-25137	Döner Sabit Kol, Mak. Ø50 mm, Kauçuk	4,20 \$
MLP-25141	Döner Ayarlı Kol, Mak. Ø18 mm, Plastik	4,40 \$
MLP-25142	Döner Ayarlı Kol, Mak. Ø18 mm, Metal	4,40 \$
MLP-25147	Döner Ayarlı Kol, Mak. Ø50 mm, Kauçuk	4,40 \$
MLP-25157	Döner Ayarlı Uzun Kol, Mak. Ø50 mm, Kauçuk	4,60 \$
MLP-25190	Çok Yönlü Spiral Tel Uç	4,20 \$
MLP-25191	Çok Yönlü Spiral Plastik Uç	4,20 \$
MLP-25212	Resetli Dikey Pim Mak. Ø12 mm, Metal	4,40 \$
MLP-25247	Resetli Döner Ayaklı Kol Makara Ø50 mm, Kauçuk	5,00 \$
MLP-25257	Resetli Döner Ayaklı Uzun Kol Makara Ø50 mm, Kauçuk	5,20 \$
MLM Metal Gövde (Kontak: NO+NC, 3A/240 V AC, Snap Action)		
MLM-25110	Dikey Pim Kısa	11,60 \$
MLM-25112	Dikey Pim Mak. Ø12 mm, Metal	11,60 \$
MLM-25121	Dikey Pim Kol Mak. Ø20 mm, Metal	11,60 \$
MLM-25132	Döner Sabit Kol Mak. Ø18 mm, Metal	11,60 \$
MLM-25137	Döner Sabit Kol Mak. Ø50 mm, Kauçuk	11,60 \$
MLM-25142	Döner Ayarlı Kol Mak. Ø18 mm, Metal	12,00 \$
MLM-25147	Döner Ayarlı Kol Mak. Ø50 mm, Kauçuk	12,00 \$
MLM-25190	Çok Yönlü Spiral Tel Uç	11,60 \$
MLM-25191	Çok Yönlü Spiral Plastik Uç	11,60 \$

CONTALI MİKRO SWITCH



ÜRÜN KODU	AÇIKLAMA	ADET (\$)
MDX-15311	Contalı	7,00 \$

MİKRO SWITCH



ÜRÜN KODU	AÇIKLAMA	ADET (\$)
Bakalit Gövde, Vidalı Terminal (Kontak: CO, 15A/250 V AC, Snap Action)		
MGB-51300	Kısa İnce Pim	3,20 \$
MGB-51305	Uzun İnce Pim	3,20 \$
MGB-51306	Kısa Pim	3,20 \$
MGB-51307	Düz Pim	3,70 \$
MGB-51308	Düz Makaralı Pim	3,90 \$
MGB-51318	Ters Makaralı Pim	3,90 \$
MGB-51701	Klasik Palet	3,20 \$
MGB-51715	Uzun Tel Palet	3,20 \$
MGB-51704	Makaralı, Kısa Palet	3,20 \$
MGB-51703	Makaralı Palet	3,20 \$
MGB-51744	Kırmalı Makaralı, Kısa Palet	3,90 \$
Switch Kılıfı		
MGB-80000	Plastik Kılıf Düz	0,60 \$
MGB-90000	Kauçuk Kılıf 45° Eğik Kablo Çıkışlı	0,60 \$

MİKRO SWITCH



ÜRÜN KODU	AÇIKLAMA	ADET (\$)
Terminal : 6.3 x 0.8 mm (Kontak: CO, 16A/250 V AC)		
KW3-02000	Pimli	1,50 \$
KW3-02001	Metal Makaralı Palet	1,50 \$
KW3-02002	Çengel Uçlu Palet	1,50 \$
KW3-02003	Düz Palet	1,50 \$
KW3-02006	Metal Makaralı, Kısa Palet	1,50 \$
KW3-02007	Uzun Palet	1,50 \$

VİNÇ KUMANDA BUTONU

ÜRÜN KODU	AÇIKLAMA	ADET (\$)
Tek Hızlı		
MVC-61020	2 Yön	3,60 \$
MVC-61040	4 Yön	5,20 \$
MVC-61060	6 Yön	7,20 \$
MVC-61080	8 Yön	9,00 \$
Tek Hızlı, Acil Stoplu		
MVC-61520	2 Yön	12,00 \$
MVC-61540	4 Yön	15,80 \$
MVC-61560	6 Yön	19,80 \$
MVC-61580	8 Yön	23,60 \$
Tek Hızlı, Acil Stoplu		
MVC-71520	2 Yön	15,20 \$
MVC-71540	4 Yön	20,00 \$
MVC-71560	6 Yön	26,00 \$
MVC-71580	8 Yön	30,60 \$
Çift Hızlı, Acil Stoplu		
MVC-82520	2 Yön	30,00 \$
MVC-82540	4 Yön	40,00 \$
MVC-82560	6 Yön	50,00 \$
MVC-82580	8 Yön	60,00 \$



TOGGLE SWITCH

ÜRÜN KODU	AÇIKLAMA	ADET (\$)
MTX-16102	On-On 3 Pin	2,60 \$
MTX-16103	On-Off-On 3 Pin	2,60 \$



KUMANDA KUTULARI VE BUTON AKSESUARLARI

ÜRÜN KODU	AÇIKLAMA / KONTAK	ADET (\$)
Kumanda Kutuları, 3A/250VAC, IP65 Contalı		
MB3-BX150	Acil Stop Butonlu	2,60 \$
MB3-BX151	Acil Stop Butonlu Korumalı	2,80 \$
MB3-BX110	Alarm Butonu	2,40 \$
Boş Buton Kutusu (Contalı - Yüksek Tip)		
MB3-BH100	1'li	1,20 \$
MB3-BH200	2'li	1,70 \$
MB3-BH300	3'lü	2,10 \$
MB3-BH400	4'lü	2,80 \$
MB3-BH500	5'li	3,80 \$
Buton Aksesuarları		
BR1	Buton için Etiket	0,30 \$
R60	060 mm Emergency Stop Etiket	0,80 \$
BK11	022 mm Buton Koruyucu 4 Parmak	0,54 \$
BK12	022 mm Buton Koruyucu 2 Parmak	0,54 \$



MB3 Ø22 PLASTİK BUTON

ÜRÜN KODU	AÇIKLAMA / KONTAK	ADET (\$)
Yaylı Buton, 3A/250VAC		
MB3-EA210	Siyah / NO	1,00 \$
MB3-EA310	Yeşil / NO	1,00 \$
MB3-EA420	Kırmızı / NC	1,00 \$
MB3-EA510	Sarı / NO	1,00 \$
MB3-EA610	Mavi / NO	1,00 \$
İşaretli Yaylı Buton, 3A/250VAC		
MB3-EA112	Beyaz (→) / NO	1,10 \$
MB3-EA212	Siyah (→) / NO	1,10 \$
MB3-EA514	Sarı Alarm / NO	1,10 \$
MB3-EA613	Mavi (↔) / NO	1,10 \$
Acil Stop Kalıcı Mantar Buton, 3A/250VAC		
MB3-ES442	Bas-Çevir 030 / NC	1,60 \$
MB3-ES542	Bas-Çevir 040 / NC	1,60 \$
MB3-ES642	Bas-Çevir 060 / NC	3,00 \$
MB3-ES142	Anahtarlı 040 / NC	3,00 \$
MB3-EC420	Kırmızı / NC	1,50 \$
İkiz Buton, 3A/250VAC		
MB3-EA845	İşıksız / NO+NC	2,60 \$
MB3-EW845	İşıklı / NO+NC	3,40 \$
Kısa Mandal Buton, 3A/250VAC, (): Yaylı Poz.		
MB3-ED210	0-1 / NO	1,20 \$
MB3-ED410	0-(1) / NO	1,40 \$
MB3-ED330	1-0-2 / 2NO	1,70 \$
MB3-ED530	(1)-0-(2) / 2NO	1,90 \$
İşıklı Yaylı Buton, Ba9S Neon, 220VAC 3A/250VAC		
MB3-EW611	Beyaz / NO	2,50 \$
MB3-EW631	Yeşil / NO	2,50 \$
MB3-EW642	Kırmızı / NC	2,50 \$
MB3-EW651	Sarı / NO	2,50 \$
MB3-EW661	Mavi / NO	2,50 \$
Ø16 Buton		
MBT-27231	Yaylı Yeşil	5,00 \$
MBT-37231	Kalıcı Yeşil	5,50 \$
Ø30 Buton		
MBW-21450	Yaylı Kırmızı	12,50 \$
MBW-89450	Acil Stop Kırmızı	17,00 \$
Ø22 Anahtarlı Buton, 3A/250VAC, (): Yaylı Poz. X: Anahtar Çıkmaz		
MB3-EG210	0 -1 / NO	2,80 \$
MB3-EG410	0-1 / NO	2,80 \$
MB3-EG610	0-(1) / NO	2,80 \$
MB3-EG330	1-0-2 / 2NO	3,30 \$
MB3-EG030	1-0-2 / 2NO	3,30 \$
MB3-EG730	(1)-0-(2) / 2NO	3,30 \$
Kontak Bloğu, 3A/250VAC		
MB1-ZB101	NO Buton için	0,50 \$
MB1-ZB102	NC Buton için	0,50 \$

MB3 Ø22 METAL BUTON

ÜRÜN KODU	AÇIKLAMA / KONTAK	ADET (\$)
Yaylı Buton, 3A/250VAC		
MB3-BA210	Siyah / NO	1,40 \$
MB3-BA310	Yeşil / NO	1,40 \$
MB3-BA420	Kırmızı / NC	1,40 \$
MB3-BA510	Sarı / NO	1,40 \$
MB3-BA610	Mavi / NO	1,40 \$
Acil Stop ve Mantar Buton, 3A/250VAC		
MB3-BS542	Bas - Çevir / NC	2,00 \$
MB3-BC420	Yaylı / NC	2,00 \$
MB3-BS142	Anahtarlı / NC	4,00 \$
Mandal Buton, 3A/250VAC		
MB3-BD210	0-1 NO	1,70 \$
MB3-BD330	1-0-2 / 2 NO	2,20 \$
İşıklı Yaylı Buton, Işık : 220VAC, Ba9S Neon 3A/250VAC		
MB3-BW611	Beyaz / NO	3,60 \$
MB3-BW631	Yeşil / NO	3,60 \$
MB3-BW642	Kırmızı / NC	3,60 \$
MB3-BW651	Sarı / NO	3,60 \$
MB3-BW661	Mavi / NO	3,60 \$
İkiz Buton, 3A/250VAC		
MB3-BA845	İşıksız / NO+NC	3,60 \$
MB3-BW845	İşıklı / NO+NC	4,40 \$
Anahtarlı Buton, 3A/250VAC, X: Anahtar Çıkmaz		
MB3-BG210	0 -1 / NO	3,50 \$
MB3-BG330	0-1-2 / NO	4,00 \$
Paslanmaz Buton		
MBJ-16200	Ø16 mm	4,50 \$
MBJ-19200	Ø19 mm	5,50 \$

Ba9S LED AMPULLER

ÜRÜN KODU	AÇIKLAMA	ADET (\$)
Ba9S Led Amp.	12V / 24V / 110V / 230V	1,20 \$

Ø22 LED SİNYAL LAMBASI



ÜRÜN KODU (230V)	ÜRÜN KODU (24V)	RENK	ADET (\$)
MB3-EV916	MB3-EV917	Beyaz	0,75 \$
MB3-EV936	MB3-EV937	Yeşil	0,70 \$
MB3-EV946	MB3-EV947	Kırmızı	0,70 \$
MB3-EV956	MB3-EV957	Sarı	0,70 \$
MB3-EV966	MB3-EV967	Mavi	0,75 \$

Ø22 BUZZER



ÜRÜN KODU	AÇIKLAMA	ADET (\$)
MB3-EB164	220V Ledli	2,20 \$
MB3-EB174	24V Ledli	2,20 \$

Ø22 VOLTMETRE SİNYAL LAMBASI (12-500V)



ÜRÜN KODU	AÇIKLAMA	ADET (\$)
MB3-EV516	Beyaz	3,60 \$
MB3-EV536	Yeşil	3,60 \$
MB3-EV546	Kırmızı	3,60 \$
MB3-EV556	Sarı	3,60 \$
MB3-EV566	Mavi	3,60 \$

Ø22 AMPERMETRE SİNYAL LAMBASI (0-100A)



ÜRÜN KODU	AÇIKLAMA	ADET (\$)
MB3-EV616	Beyaz	6,60 \$
MB3-EV636	Yeşil	6,60 \$
MB3-EV646	Kırmızı	6,60 \$
MB3-EV656	Sarı	6,60 \$
MB3-EV666	Mavi	6,60 \$

Ø8 METAL SİNYAL LAMBASI



ÜRÜN KODU (230V)	ÜRÜN KODU (24V)	RENK	ADET (\$)
MBS-35851	MBS-35871	Beyaz	1,20 \$
MBS-35853	MBS-35873	Yeşil	1,20 \$
MBS-35854	MBS-35874	Kırmızı	1,20 \$
MBS-35855	MBS-35875	Sarı	1,20 \$
MBS-35856	MBS-35876	Mavi	1,20 \$

Ø10 METAL SİNYAL LAMBASI



ÜRÜN KODU (230V)	ÜRÜN KODU (24V)	RENK	ADET (\$)
MBS-45851	MBS-45871	Beyaz	1,60 \$
MBS-45853	MBS-45873	Yeşil	1,60 \$
MBS-45854	MBS-45874	Kırmızı	1,60 \$
MBS-45855	MBS-45875	Sarı	1,60 \$
MBS-45856	MBS-45876	Mavi	1,60 \$

SİREN VE BUZZER



ÜRÜN KODU	AÇIKLAMA	ADET (\$)
Ø30 Buzzer Tek Ton		
MSS-31024	24VAC/DC	6,00 \$
MSS-31220	220VAC	6,00 \$
Ø30 Buzzer Çift Ton		
MSS-32024	12-24VAC/DC	7,00 \$
MSS-32220	220VAC	7,00 \$
Ø75 Motorlu Siren, Metal Gövde		
MSS-76012	12VDC	11,20 \$
MSS-76024	24VDC	11,20 \$
MSS-76110	110VAC	11,20 \$
MSS-76220	220VAC	11,20 \$
Elektronik Buzzer		
MSS-55012	Elektronik 12V	6,00 \$

KÖPRÜ DİYOT



ÜRÜN KODU	AÇIKLAMA	ADET (\$)
MRB-21135	35A / 1000V	1,30 \$
MRB-21150	50A / 1000V	2,50 \$

RÖLE

SOLID STATE RÖLE

ÜRÜN KODU	VOLTAJ	ADET (\$)
Mini Röle, 1 Kontak - 5 Pin, 10A / 250VAC		
MRL-41005	230VAC	5,00 \$
MRL-41006	12VDC	2,80 \$
MRL-41007	24VDC	2,80 \$
Mini Röle, 2 Kontak - 8 Pin, 5A / 250VAC		
MRL-42004	230VAC	5,00 \$
MRL-42006	12VDC	2,80 \$
MRL-42007	24VDC	2,80 \$
2 Kontak - 8 Pin, Kontak: 2CO, 10A/250VAC		
MRL-52001	12VAC	3,20 \$
MRL-52002	24VAC	3,20 \$
MRL-52004	110VAC	3,20 \$
MRL-52005	230VAC	3,20 \$
MRL-52006	12VDC	3,20 \$
MRL-52007	24VDC	3,20 \$
4 Kontak - 14 Pin, Kontak: 4CO, 5A/250VAC		
MRL-54001	12VAC	3,20 \$
MRL-54002	24VAC	3,20 \$
MRL-54004	110VAC	3,20 \$
MRL-54005	230VAC	3,20 \$
MRL-54006	12VDC	3,20 \$
MRL-54007	24VDC	3,20 \$
2 Kontak - 8 Pin, Kontak: 2CO, 10A/250VAC		
MRL-62001	12VAC	6,00 \$
MRL-62002	24VAC	6,00 \$
MRL-62004	110VAC	6,00 \$
MRL-62005	230VAC	6,00 \$
MRL-62006	12VDC	6,00 \$
MRL-62007	24VDC	6,00 \$
3 Kontak - 11 Pin, Kontak: 3CO, 10A/250VAC		
MRL-63001	12VAC	6,00 \$
MRL-63002	24VAC	6,00 \$
MRL-63004	110VAC	6,00 \$
MRL-63005	230VAC	6,00 \$
MRL-63006	12VDC	6,00 \$
MRL-63007	24VDC	6,00 \$

ÜRÜN KODU	AÇIKLAMA	ADET (\$)
DC-AC 1 Kutup, Giriş: 3-32VDC Çıkış: 24-480VAC		
MSR-21015	1x15A	11,00 \$
MSR-21025	1x25A	12,00 \$
MSR-21040	1x40A	15,00 \$
MSR-21050	1x50A	19,00 \$
MSR-21060	1x60A	22,00 \$
MSR-21080	1x80A	27,00 \$
MSR-21090	1x90A	29,00 \$
DC-AC 3 Kutup, Giriş: 3-32VDC Çıkış: 24-530VAC		
MSR-23015	3x15A	46,00 \$
MSR-23025	3x25A	50,00 \$
MSR-23040	3x40A	64,00 \$
MSR-23050	3x50A	68,00 \$
MSR-23060	3x60A	70,00 \$
MSR-23080	3x80A	78,00 \$
MSR-23090	3x90A	96,00 \$
AC-AC 1 Kutup, Giriş: 80-250VDC Çıkış: 24-480VAC		
MSR-51015	1x15A	13,00 \$
MSR-51025	1x25A	14,00 \$
MSR-51040	1x40A	17,00 \$
MSR-51050	1x50A	21,00 \$
MSR-51060	1x60A	24,00 \$
MSR-51080	1x80A	29,00 \$
MSR-51090	1x90A	31,00 \$
AC-AC 3 Kutup, Giriş: 80-250VDC Çıkış: 24-530VAC		
MSR-53015	3x15A	56,00 \$
MSR-53025	3x25A	60,00 \$
MSR-53040	3x40A	74,00 \$
MSR-53050	3x50A	78,00 \$
MSR-53060	3x60A	80,00 \$
MSR-53080	3x80A	88,00 \$
MSR-53090	3x90A	106,00 \$
DC-DC 1 Kutup, Giriş: 3-32VDC Çıkış: 5-110VDC		
MSR-31015	1x15A	15,00 \$
MSR-31025	1x25A	16,00 \$
MSR-31040	1x40A	19,00 \$
MSR-31050	1x50A	23,00 \$
MSR-31060	1x60A	26,00 \$
Ohm-AC 1 Kutup, Giriş: 470-560kOhm Çıkış: 0-280VAC, Triac(Analog)		
MSR-91015	1x15A	15,00 \$
MSR-91025	1x25A	16,00 \$
MSR-91040	1x40A	19,00 \$
MSR-91050	1x50A	23,00 \$
MSR-91060	1x60A	26,00 \$



MSC-80 054 14 Pin

MSC-80 062 8 Pin
MSC-80 063 11 Pin

MSC-90 D41 5 Pin
MSC-90 D42 8 Pin

MSC-90 052 8 Pin
MSC-90 054 14 Pin

MSC-90 062 8 Pin
MSC-90 063 11 Pin



Ø6,5 ENDÜKTİF SENSÖR

ÜRÜN KODU	ÇIKIŞ	FONK.	VOLTAJ	ADET (\$)
M6 Gövde, Algılama: 1mm, Düz Kafa				
LM6-3001NA	NPN	NO	10-30VDC	15,00 \$
LM6-3001NB	NPN	NC	10-30VDC	17,00 \$
LM6-3001PA	PNP	NO	10-30VDC	15,00 \$
LM6-3001PB	PNP	NC	10-30VDC	17,00 \$
M6 Endüktif Sensör, Algılama: 2mm, Çıkık Kafa				
LM6-3002NA	NPN	NO	10-30VDC	15,00 \$
LM6-3002NB	NPN	NC	10-30VDC	17,00 \$
LM6-3002PA	PNP	NO	10-30VDC	15,00 \$
LM6-3002PB	PNP	NC	10-30VDC	17,00 \$

M8 ENDÜKTİF SENSÖR

ÜRÜN KODU	ÇIKIŞ	FONK.	VOLTAJ	ADET (\$)
M8 Gövde - Kablolu, Algılama: 1mm, Düz Kafa				
LM8-3001NA	NPN	NO	10-30VDC	14,00 \$
LM8-3001NB	NPN	NC	10-30VDC	17,00 \$
LM8-3001PA	PNP	NO	10-30VDC	14,00 \$
LM8-3001PB	PNP	NC	10-30VDC	17,00 \$
LM8-3001LA	DC 2Tel	NO	10-30VDC	24,00 \$
LM8-2001A	AC 2Tel	NO	90-250VAC	24,00 \$
M8 Gövde - Kablolu, Algılama: 2mm, Çıkık Kafa				
LM8-3002NA	NPN	NO	10-30VDC	14,00 \$
LM8-3002NB	NPN	NC	10-30VDC	17,00 \$
LM8-3002PA	PNP	NO	10-30VDC	14,00 \$
LM8-3002PB	PNP	NC	10-30VDC	17,00 \$
LM8-3002LA	DC 2Tel	NO	10-30VDC	24,00 \$
LM8-2002A	AC 2Tel	NO	90-250VAC	24,00 \$
M8 Gövde - Konnektörlü, Algılama: 1mm, Düz Kafa				
LM8-3001NAT	NPN	NO	10-30VDC	19,00 \$
LM8-3001NBT	NPN	NC	10-30VDC	22,00 \$
LM8-3001PAT	PNP	NO	10-30VDC	19,00 \$
LM8-3001PBT	PNP	NC	10-30VDC	22,00 \$
M8 Gövde - Konnektörlü, Algılama: 2mm, Çıkık Kafa				
LM8-3002NAT	NPN	NO	10-30VDC	19,00 \$
LM8-3002NBT	NPN	NC	10-30VDC	22,00 \$
LM8-3002PAT	PNP	NO	10-30VDC	19,00 \$
LM8-3002PBT	PNP	NC	10-30VDC	22,00 \$
M12 Konnektörlü, Algılama: 1mm, Düz Kafa				
LM8-3001NAT-M12	NPN	NO	10-30VDC	21,00 \$
LM8-3001NBT-M12	NPN	NC	10-30VDC	24,00 \$
LM8-3001PAT-M12	PNP	NO	10-30VDC	21,00 \$
LM8-3001PBT-M12	PNP	NC	10-30VDC	24,00 \$
M12 Konnektörlü, Algılama: 2mm, Çıkık Kafa				
LM8-3002NAT-M12	NPN	NO	10-30VDC	21,00 \$
LM8-3002NBT-M12	NPN	NC	10-30VDC	24,00 \$
LM8-3002PAT-M12	PNP	NO	10-30VDC	21,00 \$
LM8-3002PBT-M12	PNP	NC	10-30VDC	24,00 \$

M12 ENDÜKTİF SENSÖR

ÜRÜN KODU	ÇIKIŞ	FONK.	VOLTAJ	ADET (\$)
M12 Gövde - Kablolu, Algılama: 2mm, Düz Kafa				
LM12-3002NA	NPN	NO	10-30VDC	9,50 \$
LM12-3002NC	NPN	NO+NC	10-30VDC	13,00 \$
LM12-3002PA	PNP	NO	10-30VDC	9,50 \$
LM12-3002PC	PNP	NO+NC	10-30VDC	13,00 \$
LM12-3002LA	DC 2Tel	NO	10-30VDC	17,50 \$
LM12-3002LB	DC 2Tel	NC	10-30VDC	17,50 \$
LM12-2002A	AC 2Tel	NO	90-250VAC	17,50 \$
M12 Gövde - Kablolu, Algılama: 4 mm, Çıkık Kafa				
LM12-3004NA	NPN	NO	10-30VDC	9,50 \$
LM12-3004NC	NPN	NO+NC	10-30VDC	13,00 \$
LM12-3004PA	PNP	NO	10-30VDC	9,50 \$
LM12-3004PC	PNP	NO+NC	10-30VDC	13,00 \$
LM12-3004LA	DC 2Tel	NO	10-30VDC	17,50 \$
LM12-3004LB	DC 2Tel	NC	10-30VDC	17,50 \$
LM12-2004A	AC 2Tel	NO	90-250VAC	17,50 \$
M12 Gövde - M12 Konnektörlü, Algılama: 2 mm, Düz Kafa				
LM12-3002NAT	NPN	NO	10-30VDC	11,50 \$
LM12-3002NCT	NPN	NO+NC	10-30VDC	15,50 \$
LM12-3002PAT	PNP	NO	10-30VDC	11,50 \$
LM12-3002PCT	PNP	NO+NC	10-30VDC	15,50 \$
M12 Gövde - M12 Konnektörlü, Algılama: 4 mm, Çıkık Kafa				
LM12-3004NAT	NPN	NO	10-30VDC	11,50 \$
LM12-3004NCT	NPN	NO+NC	10-30VDC	15,50 \$
LM12-3004PAT	PNP	NO	10-30VDC	11,50 \$
LM12-3004PCT	PNP	NO+NC	10-30VDC	15,50 \$

ALARM BUTONU



ÜRÜN KODU	AÇIKLAMA	ADET (\$)
MB3-BX 110	Alarm Butonu	2,80 \$

5'Lİ EL TERMİNALİ



ÜRÜN KODU	AÇIKLAMA	ADET (\$)
MB3-BZ556	5'li El Terminali	13,00 \$

ACİL STOP BUTONU



ÜRÜN KODU	AÇIKLAMA	ADET (\$)
MB3-BX150	Acil Stop Butonu	2,60 \$
MB3-BX151	Korumalı Acil Stop Butonu	2,80 \$

6'Lİ EL TERMİNALİ



ÜRÜN KODU	AÇIKLAMA	ADET (\$)
MB3-BZ607	6'li El Terminali	15,50 \$

ALARM



ÜRÜN KODU	AÇIKLAMA	ADET (\$)
MB3-BX121	Pilli	7,00 \$

KUYU DİBİ REVİZYON KUTUSU



ÜRÜN KODU	AÇIKLAMA	ADET (\$)
MB3-CK400	Kuyu Dibi Revizyon Kutusu	🌀

FİŞ KONTAK



ÜRÜN KODU	AÇIKLAMA	ADET (\$)
MSW-41500	Fiş Kontak	🌀

ASANSÖR ELEKTRİK DAĞITIM PANOSU



BOBİNLİ SWITCH



ÜRÜN KODU	AÇIKLAMA	ADET (\$)
MLC-25100-2	24V	🌀
MLC-25100-5	220V	

ŞERİT MIKNATIS



ÜRÜN KODU	AÇIKLAMA	ADET (\$)
MLV-M001	22 mm Yuvarlak	🌀
MLV-M100	10 cm	
MLV-M300	30 cm	

ÜRÜN KODU	AÇIKLAMA	ADET (\$)
MB3-CB264	Momentum 6 Kutuplu (6x40A Şalterli) 2 Kaçak Akım Röleli	78,00 \$

Ø22 mm SİNYAL LAMBASI LED



ÜRÜN KODU	AÇIKLAMA	RENK	FİYAT	KUTU ADEDİ
220 VAC				
ASG-AD22-42220	Ø 22 mm, LED, 220 VAC	Kırmızı	⌚	10
ASG-AD22-31220	Ø 22 mm, LED, 220 VAC	Yeşil		10
ASG-AD22-51220	Ø 22 mm, LED, 220 VAC	Sarı		10
ASG-AD22-61220	Ø 22 mm, LED, 220 VAC	Mavi		10
ASG-AD22-11220	Ø 22 mm, LED, 220 VAC	Beyaz		10
24 VDC				
ASG-AD22-3124	Ø 22 mm, LED, 24 V DC	Yeşil	⌚	10
ASG-AD22-4224	Ø 22 mm, LED, 24 V DC	Kırmızı		10
ASG-AD22-5124	Ø 22 mm, LED, 24 V DC	Sarı		10

Ø22 mm VOLTMETRELİ SİNYAL LAMBASI LED



ÜRÜN KODU	AÇIKLAMA	ÇALIŞMA ARALIĞI	RENK	ADET (t)	KUTU ADEDİ
AD22VM-42220	Ø 22 mm, LED, 220 VAC	50-500 VAC	Kırmızı	⌚	10
AD22VM-31220	Ø 22 mm, LED, 220 VAC	50-500 VAC	Yeşil		10
AD22VM-51220	Ø 22 mm, LED, 220 VAC	50-500 VAC	Sarı		10

Ø10 mm SİNYAL LAMBASI LED 220V



ÜRÜN KODU	AÇIKLAMA	RENK	FİYAT	KUTU ADEDİ
AD10-31220	Ø 10 mm, LED, 220 VAC	Kırmızı	⌚	10
AD10-42220	Ø 10 mm, LED, 220 VAC	Yeşil		10
AD10-51220	Ø 10 mm, LED, 220 VAC	Sarı		10

BUZZERLER (Ø 22 mm LED'li Buzzer 90 dB)



ÜRÜN KODU	AÇIKLAMA	RENK	FİYAT	KUTU ADEDİ
AD22-220SM/R	Ø 22 mm Sesli-Led Flaşör İkazlı 220 V AC	●	⌚	10
AD22-24SM/R	Ø 22 mm Sesli-Led Flaşör İkazlı 24 V AC-DC	●		10

SİRENLER



ÜRÜN KODU	AÇIKLAMA	RENK	FİYAT	KUTU ADEDİ
Ø 50 mm Siren (120 dB)				
PS-101,12-24 V	Siren 12 - 24 V AC/DC Plastik Gövde	●	⌚	1
PS-101, 220 V	Siren 220V AC Plastik Gövde	●		1
ES-220, 12 V	Siren 12V DC Plastik Gövde	●		1

HOPARLÖR



ÜRÜN KODU	AÇIKLAMA	FİYAT	KUTU ADEDİ
SP-57 / 0.5 w	57 mm Çap, 8 ohm 0.5 W Hoparlör	⌚	100
SP-77 / 1 w	77 mm Çap, 8 ohm 1 W Hoparlör		100

KÖPRÜ DİYOT



ÜRÜN KODU	AÇIKLAMA	FİYAT	KUTU ADEDİ
KBPC-3510	35 A / 1000 V	⌚	50
KBPC-5010	50 A / 1000 V		50

LAY5 SERİSİ (Ø22 mm Butonlar)

YAYLI BUTON 3A / 240 V AC, IP 44

PLASTİK BUTON SERİSİ



ÜRÜN KODU	RENK	AÇIKLAMA	KONTAK	FİYAT	KUTU ADEDİ
LAY5-EA31	●	Start Buton	NO	⌚	20
LAY5-EA42	●	Stop Buton	NC		20
LAY5-EA51	●	Start Buton	NO		20
LAY5-EA61	●	Start Buton	NO		20
LAY5-EA21	●	Start Buton	NO		20
LAY5-EA2351	⚠	Start Buton	NO		20
LAY5-EA7321	☀	Start Buton	NO		20
LAY5-EA3341	↑	Start Buton	NO		20
LAY5-EA3351	↓	Start Buton	NO		20
LAY5-EA6361	↕	Start Ortak Buton	NO		20
LAY5-EL8325	■	Start Stop İkiz Buton	NO+NC		20
LAY5-EL3371	↑ ↓	Start İkiz Buton Oklu	NO+NO		20

METAL BUTON SERİSİ

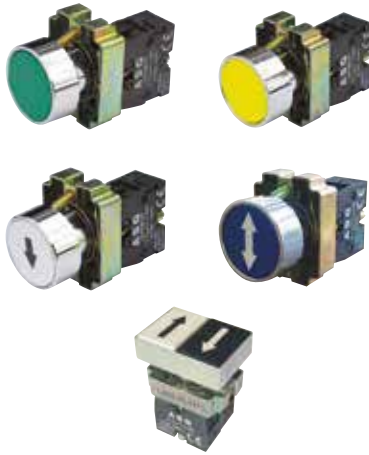

ÜRÜN KODU	RENK	AÇIKLAMA	KONTAK	FİYAT	KUTU ADEDİ
LAY5-BA31	●	Start Buton	NO	⌚	20
LAY5-BA42	●	Stop Buton	NC		20
LAY5-BA51	●	Start Buton	NO		20
LAY5-BA61	●	Start Buton	NO		20
LAY5-BA21	●	Start Buton	NO		20
LAY5-BA2351	⚠	Start Buton	NO		20
LAY5-BA7321	☀	Start Buton	NO		20
LAY5-BA3341	↑	Start Buton	NO		20
LAY5-BA3351	↓	Start Buton	NO		20
LAY5-BA6361	↕	Start Ortak Buton	NO		20
LAY5-BL8325	■	Start Stop İkiz Buton	NO+NC		20
LAY5-BL3371	↑ ↓	Start İkiz Buton Oklu	NO+NO		20

LAY5 SERİSİ (Ø22 mm Butonlar)

PLASTİK BUTON SERİSİ

MANTAR BUTON 3A / 240 V AC,
IP 44



ÜRÜN KODU	AÇIKLAMA	KONTAK	FİYAT	KUTU ADEDİ
LAY5-ES542	Acil Stop Buton Kırmızı	NC	⌚	20

METAL BUTON SERİSİ

MANTAR BUTON 3A / 240 V AC,
IP 44

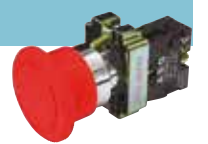

ÜRÜN KODU	AÇIKLAMA	KONTAK	FİYAT	KUTU ADEDİ
LAY5-BS542	Acil Stop Buton Kırmızı	NC	⌚	20

MANDAL BUTON 3A / 240 V AC,
IP 44



ÜRÜN KODU	AÇIKLAMA	KONTAK	FİYAT	KUTU ADEDİ
LAY5-EJ21	Mandal Buton Uzun 0-1	NO	⌚	20
LAY5-ED21	Mandal Buton Kısa 0-1	NO		20
LAY5-ED33	Mandal Buton Kısa 1-0-2	2 NO		20
LAY5-ED53	Mandal Buton Kısa 1-0-2	2NO		20

MANDAL BUTON 3A / 240 V AC,
IP 44



ÜRÜN KODU	AÇIKLAMA	KONTAK	FİYAT	KUTU ADEDİ
LAY5-BJ21	Mandal Buton Uzun 0-1	NO	⌚	20
LAY5-BD21	Mandal Buton Kısa 0-1	NO		20
LAY5-BD33	Mandal Buton Kısa 1-0-2	2 NO		20
LAY5-BD41	Mandal Buton Kısa 0-1	2NO		20

LAY5 SERİSİ (Ø22 mm Butonlar)



YEDEK KONTAK
3A / 240 V AC, IP 44



ANAHTARLI BUTON
3A / 240 V AC, IP 44

ÜRÜN KODU	AÇIKLAMA	FİYAT	KUTU ADEDİ
LAY5-BE101	Kontak Bloğu NO	⚡	150
LAY5-BE102	Kontak Bloğu NC		150

ÜRÜN KODU	AÇIKLAMA	KONTAK	FİYAT	KUTU ADEDİ
LAY5-BG21	Anahtarlı Buton 0-1	NO	⚡	20
LAY5-BG73	Anahtarlı Buton 1-0-2 Sağa-Sola Kayıcı	2NO		20
LAY5-EG61	Anahtarlı Buton 0-1 Kayıcı	NO		20
LAY5-EG73	Anahtarlı Buton 1-0-2 Sağa-Sola Kayıcı	2NO		20
LAY5-BG61	Anahtarlı Buton 0-1 Kayıcı	NO		20

LAY5 SERİSİ TEKLİ KUMANDA KUTUSU



ÜRÜN KODU	AÇIKLAMA	KONTAK	FİYAT	KUTU ADEDİ
LAY5-ESBK542	Emergency stop muhafazalı (EKO SERİ)	NC	⚡	100
LAY5-J174H29P	Emergency stop muhafazalı	NC		100
LAY5-JHEA21	1'li boş kutuya monte aydınlatma butonu	NO		100
LAY5-JHEG61	1'li boş kutuya monte kuyu dışından revizyon reset anahtar	NO		100
LAY5-JH24SM/R	1'li boş kutuya monte 24VDC Bypass buzzer	NO		100

LAY5 SERİSİ 4'LÜ KUMANDA KUTUSU (Asansörler İçin)



ÜRÜN KODU	AÇIKLAMA	FİYAT	KUTU ADEDİ
LAY5-EJ140	4'lü Plastik Butonlu, Miknatıs Tabanlı El Kumanda Butonu	⚡	30
LAY5-EJ151	5'li Plastik Butonlu, Miknatıs Tabanlı El Kumanda Butonu		30
LAY5-EJ1451	6'lı Plastik Butonlu, Miknatıs Tabanlı El Kumanda Butonu		30

ASANSÖR KUYUDİBİ MUAYENE İSTASYONU

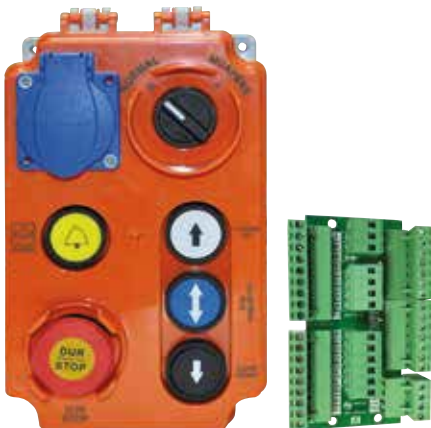

ÜRÜN KODU	AÇIKLAMA	FİYAT	KUTU ADEDİ
KD701	Asansör Kuyudibi Muayene İstasyonu, Butonlu	⚡	1
KDK702	Asansör Kuyudibi Muayene İstasyonu, Butonlu ve Kuyudibi Klemens Kartı Örülmüş Olarak		1
KDKK1-A	Kuyudibi Muayene istasyonu klemens kartı		1

KUMANDA KUTULARI



ÜRÜN KODU	AÇIKLAMA	FİYAT	KUTU ADEDİ
JBH4602	1-0-2 Kayıcı Anahtarlı Buton, 0-1 Mandal Buton, Sinyal Lambası, Aydınlatma Butonu, 2 Adet Fren Butonu	⌚	1
JBH68BYP	Bypass Pako, İkiz Start Buton, Aydınlatma Butonu, 1-0-2 Kayıcı Anahtarlı Buton, 0-1 Mandal Buton, Sinyal Lambası, Priz		1

LAY5-HBX SERİSİ BOŞ KUTULAR (YÜKSEK TİP)

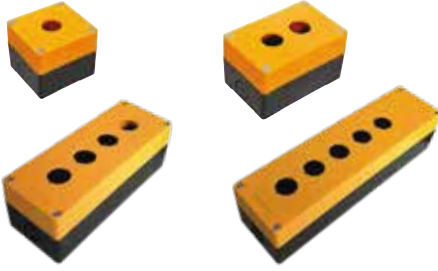

ÜRÜN KODU	AÇIKLAMA	FİYAT	KUTU ADEDİ
LAY5-JHBX1	1'li Sarı Siyah Boş Kutu	⌚	100
LAY5-JHBX2	2'li Sarı Siyah Boş Kutu		100
LAY5-JHBX3	3'lü Sarı Siyah Boş Kutu		75
LAY5-JHBX4	4'lü Sarı Siyah Boş Kutu		50
LAY5-JHBX5	5'li Sarı Siyah Boş Kutu		50
LAY5-JHBX6	6'li Sarı Siyah Boş Kutu		50

ASANSÖRLER İÇİN MIKNATISLAR

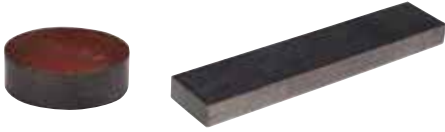

ÜRÜN KODU	AÇIKLAMA	FİYAT	KUTU ADEDİ
22x7	22 mm Çap, 7 mm Yükseklik, Kırmızı Boyalı Yuvarlak Mıknatıs	⌚	1500
10 cm Şerit Mıknatıs	20 mm en, 8 mm Yükseklik, Şerit Mıknatıs		360
30 cm Şerit Mıknatıs	20 mm en, 8 mm Yükseklik, Şerit Mıknatıs		120

MİNİ RÖLE ve SOKET

1 Kontak 5 Pin Minyatür Röle



İğne Bacaklı,
10A

ÜRÜN KODU	AÇIKLAMA	FİYAT	KUTU ADEDİ
JQX-14FC-1Z-24V	1 Kontak, 5 Pin Minyatür Röle, İğne Bacaklı 24 V DC	⌚	100
JQX-14FC-1Z-220V	1 Kontak, 5 Pin Minyatür Röle, İğne Bacaklı 220 V AC		100

2 Kontak 8 Pin Minyatür Röle



İğne Bacaklı,
5A

ÜRÜN KODU	AÇIKLAMA	FİYAT	KUTU ADEDİ
JQX-14FC-1Z-12V	2 Kontak, 8 Pin Minyatür Röle, İğne Bacaklı 12 V DC	⌚	100
JQX-14FC-2Z-24V	2 Kontak, 8 Pin Minyatür Röle, İğne Bacaklı 24 V DC		100
JQX-14FC-2Z-220V	2 Kontak, 8 Pin Minyatür Röle, İğne Bacaklı 220 V AC		100

5 Pin Röle Soketi



ÜRÜN KODU	AÇIKLAMA	FİYAT	KUTU ADEDİ
14F-1Z-C2	5 Pin Tek Kontak Röle Soketi Kısa, Raya Montaj	⌚	20

8 Pin Röle Soketi



ÜRÜN KODU	AÇIKLAMA	FİYAT	KUTU ADEDİ
14F-2Z-C2	8 Pin Çift Kontak Röle Soketi Kısa, Raya Montaj	⌚	20
14F-2Z-C3	8 Pin Çift Kontak Röle Soketi, Raya Montaj Röle Tutucu		20

**BAKIR İLETKENLER İÇİN REÇİNELİ KABLO EK MUFLARI (0.6 - 1 kV)****ŞEFFAF REÇİNELİ KABLO EK MUFLARI (0.6 - 1 kV)****PROTOLİNLER / REÇİNELER****A.G. PABUÇLU REÇ. KAB. BAŞLIKLARI (0.6 - 1 kV)****O.G. 3 DAMARLI HARİCİ ISI BÜZ. KAB. BAŞ. (20.8-36 kV)****FERMUARLI ISI BÜZ. KAB. EK MUF (0.6 - 1 kV)****PLASTİK HUNİ KALIPLARI****BAKIR İLETKENLER İÇİN ISI BÜZÜŞMELİ KABLO EK MUFLARI (0.6 - 1 kV)**

ISI BÜZÜŞMELİ MAKARONLAR/ HEAT SHRINKABLE TUBES

ÜRÜN YUVARLAK BORU FORMUNDA İÇ ÇAP DARALMA ÖNCESİ (mm)	ÜRÜN YUVARLAK BORU FORMUNDA İÇ ÇAP DARALMA SONRASI (mm)	Dikdörtgen kesitli BARAYA UYGUNLUK (mm)	Kablo ve Pabucuna Uygunluk 1 damar kesiti (mm ²)	PAKET RULO MİKTARI (mt)
1,5	0,75		1 mm ve altı	200
2,5	1,25		0,5-0,75	200
3,5	1,75		0,75-1-1,5	200
4,5	2,25		1,5-2,5	100
5	2,5		2,5	100
6	3		4-6	100
7	3,5		6	100
8	4		6-10	100
10	5		10-16	100
12	6		10-16	100
13	6,5	12X2-15X2-15X3	16-25	100
16	8	20X2-20X3	16-25-35-50	100
18	9	20X5	35-50	100
20	10	20X5-25X3-25X5	70	100
22	11	25X5-30X3-30X5	70-95	100
25	12,5	25X5-30X3-30X5	70-95	50
28	14	40X3	70-95	50
30	15	40X3-40X5	120	50
32	16	30X10-40X5	120-150	50
35	17,5	30X10-40X5-40X10	150	50
38	19	40X5-40X10	185-240	50
40	20	50X5	185-240-300	50
45	22,5	50X5-50X10	240-300-400	25
50	25	60X5-60X10	400	25
60	30	80X5-80X10		25
70	35	100X5-100X10		25
80	40	100X5-100X10		25
90	45	100X10		25
100	50	120X10		25
120	60	120X10-160X10		25
150	75	160X10		25



SİPARİŞ ESNASINDA RENK BELİRTİNİZ!

11 Siyah	12 Sarı/Yeşil	13 Kırmızı	14 Sarı	15 Mavi	16 Yeşil	17 Gri	18 Kahve	19 Beyaz	20 Şeffaf
----------	---------------	------------	---------	---------	----------	--------	----------	----------	-----------

POLİOLEFİN MALZEMEDEN İMAL 2/1 ORANINDA DARALAN MAKARON



UL-1 SERTİFİKALI RoHS, ISO BELGELİ, 600 V
ÇALIŞMA SICAKLIĞI -55 °C + 125 °C



Ölçüler		Daralmadan Önce (mm)		Daralmadan Sonra (mm)		Metre Fiyatı (\$)	Makara (m)	
Inc (Ø)	mm	İç Çap	Cidar Kalınlığı	İç Çap	Cidar Kalınlığı			
3 / 64	0.8	1,1 ± 0,2	0,15 ± 0,05	0,40	0,28 ± 0,10	0,165 USD	200	
	1	1,5 ± 0,2	0,15 ± 0,05	0,50	0,28 ± 0,10	0,090 USD	200	
	1.2	2,0 ± 0,2	0,15 ± 0,05	0,70	0,30 ± 0,10	0,090 USD	200	
	1.5	2,0 ± 0,2	0,18 ± 0,05	0,85	0,32 ± 0,10	0,097 USD	200	
1 / 16	1.6	2,0 ± 0,3	0,15 ± 0,05	0,80	0,28 ± 0,10	0,104 USD	200	
	2	2,5 ± 0,2	0,18 ± 0,05	0,60	0,28 ± 0,10	0,115 USD	200	
3 / 32	2.4	3,0 ± 0,3	0,18 ± 0,05	1,20	0,35 ± 0,10	0,115 USD	200	
	2.5	3,0 ± 0,2	0,18 ± 0,05	1,30	0,38 ± 0,10	0,150 USD	200	
	3	3,5 ± 0,2	0,18 ± 0,05	1,50	0,40 ± 0,10	0,160 USD	200	
1 / 8	3.2	3,5 ± 0,4	0,18 ± 0,05	1,60	0,40 ± 0,10	0,160 USD	200	
	3.5	4,0 ± 0,2	0,22 ± 0,05	1,80	0,42 ± 0,10	0,170 USD	200	
	4	4,5 ± 0,2	0,25 ± 0,05	2,00	0,45 ± 0,10	0,200 USD	200	
	4.5	5,0 ± 0,2	0,25 ± 0,05	2,30	0,50 ± 0,10	0,230 USD	100	
3 / 16	4.8	5,2 ± 0,4	0,25 ± 0,05	2,40	0,50 ± 0,10	0,230 USD	100	
	5	5,5 ± 0,2	0,25 ± 0,05	2,50	0,55 ± 0,10	0,250 USD	100	
	6	6,5 ± 0,2	0,28 ± 0,05	3,00	0,55 ± 0,10	0,290 USD	100	
1 / 4	6.4	7,0 ± 0,4	0,28 ± 0,05	3,20	0,55 ± 0,10	0,290 USD	100	
	7	7,5 ± 0,3	0,28 ± 0,05	3,50	0,55 ± 0,10	0,350 USD	100	
	8	8,5 ± 0,3	0,28 ± 0,05	4,00	0,60 ± 0,10	0,350 USD	100	
	9	9,5 ± 0,3	0,30 ± 0,08	4,50	0,60 ± 0,10	0,360 USD	50	
3 / 8	9.5	10,0 ± 0,5	0,30 ± 0,08	4,80	0,60 ± 0,10	0,360 USD	100	
	10	10,5 ± 0,3	0,30 ± 0,08	5,00	0,60 ± 0,10	0,390 USD	100	
	11	11,5 ± 0,3	0,30 ± 0,08	5,50	0,60 ± 0,10	0,442 USD	100	
	12	12,5 ± 0,3	0,30 ± 0,08	6,00	0,60 ± 0,10	0,450 USD	100	
1 / 2	12.7	13,0 ± 0,5	0,30 ± 0,08	6,40	0,60 ± 0,10	0,450 USD	100	
	13	13,5 ± 0,3	0,35 ± 0,10	6,50	0,65 ± 0,10	0,500 USD	100	
	14	14,5 ± 0,3	0,35 ± 0,10	7,00	0,65 ± 0,10	0,580 USD	100	
	15	15,5 ± 0,3	0,35 ± 0,10	7,00	0,65 ± 0,10	0,675 USD	100	
	16	16,5 ± 0,4	0,40 ± 0,12	8,00	0,70 ± 0,10	0,750 USD	100	
	17	17,5 ± 0,4	0,40 ± 0,12	8,50	0,70 ± 0,10	0,975 USD	100	
	18	19,0 ± 0,5	0,40 ± 0,15	9,00	0,80 ± 0,15	0,980 USD	100	
	19.1	20,5 ± 0,6	0,40 ± 0,15	9,50	0,80 ± 0,15	0,980 USD	100	
3 / 4	20	21,0 ± 0,6	0,40 ± 0,15	10,00	0,80 ± 0,15	1,250 USD	100	
	22	23,0 ± 0,5	0,40 ± 0,15	11,00	0,80 ± 0,15	1,560 USD	100	
4 / 5	1	25,4 ± 0,7	0,45 ± 0,12	14,00	0,90 ± 0,15	1,650 USD	50	
	30	31,5 ± 1,0	0,50 ± 0,15	15,00	0,90 ± 0,15	2,150 USD	50	
1-1 / 4	1-1 / 4	32	33,0 ± 0,7	0,50 ± 0,15	15,90	0,95 ± 0,15	2,150 USD	50
	35	36,5 ± 1,0	0,50 ± 0,15	17,50	0,95 ± 0,15	2,800 USD	50	
1-1 / 2	1-1 / 2	38	40,0 ± 0,7	0,50 ± 0,15	19,10	1,00 ± 0,15	3,000 USD	50
	40	41,5 ± 1,0	0,55 ± 0,15	20,00	1,00 ± 0,15	3,000 USD	50	
	2	51	52,5 ± 0,7	0,55 ± 0,15	25,40	0,95 ± 0,15	3,800 USD	25
3	60	60	0,60 ± 0,15	30,00	1,30 ± 0,20	5,100 USD	25	
	70	70	0,65 ± 0,15	35,00	1,30 ± 0,20	6,900 USD	25	
	76	80,0 ± 1,0	0,65 ± 0,15	38,10	1,30 ± 0,20	7,500 USD	25	
	80	80	0,65 ± 0,15	40,00	1,46 ± 0,20	7,500 USD	25	
4	90	90	0,65 ± 0,15	45,00	1,46 ± 0,20	8,500 USD	25	
	96	100	0,65 ± 0,15	50,00	1,46 ± 0,20	9,500 USD	25	
	102	105,0 ± 1,0	0,65 ± 0,20	50,80	1,46 ± 0,20	9,500 USD	25	
	5	120	120	0,65 ± 0,20	63,50	1,56 ± 0,20	13,000 USD	25
5	150	150	0,65 ± 0,20	75,00	1,56 ± 0,20	20,000 USD	25	
	180	180	0,65 ± 0,30	90,00	1,56 ± 0,20	28,000 USD	25	
	250	250	0,65 ± 0,30	125,00	1,56 ± 0,20	55,000 USD	20	

Baraya Uygun Makaron Çap Hesabı

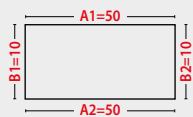

$$\frac{50+50+10+10}{\pi : 3,14} = 40\text{mm}$$

$$\frac{A1+A2+B1+B2}{\pi : 3,14} = \varnothing$$

* Siparişinizde makaron rengi belirtiniz.
* Kullandığınız üründe radius var ise hesaplamanızı gözden geçirin.



2/1 RENKLİ ISI İLE DARALAN MAKARON



Renkler	İnc	mm	Metre Fiyatı (\$)	Makara (m)	Kahverengi Metre Fiyatı (\$)	Sarı - Yeşil Metre Fiyatı (\$)
Beyaz	1/16	1,6	0,10 USD	200	0,12 USD	0,60 USD
		2,0	0,14 USD	200	-	-
	3/32	2,4	0,15 USD	200	0,16 USD	0,42 USD
		2,5	0,16 USD	200	0,18 USD	-
Sarı	1/8	3,2	0,19 USD	200	0,22 USD	0,43 USD
		3,5	0,21 USD	200	0,27 USD	0,44 USD
	3/16	4,8	0,26 USD	100	0,29 USD	0,44 USD
Mavi	1/4	6,4	0,33 USD	100	0,37 USD	0,50 USD
		7	0,38 USD	100	-	-
	3/8	9,5	0,40 USD	100	0,45 USD	0,68 USD
		1/2	12,7	0,52 USD	100	0,57 USD
Kırmızı	-	16	0,86 USD	100	1,00 USD	1,46 USD
		3/4	19,1	1,38 USD	100	1,42 USD
	4/5	20	1,50 USD	100	1,57 USD	1,86 USD
		1	25,4	1,86 USD	50	2,10 USD
Yeşil	1-1/4	32	2,43 USD	50	2,70 USD	3,70 USD
		35	3,40 USD	50	3,90 USD	4,50 USD
	1-1/2	38	3,50 USD	50	4,00 USD	5,00 USD
		40	3,80 USD	40	-	5,50 USD
Şeffaf	2	51	4,20 USD	50	5,00 USD	7,00 USD
		60	6,00 USD	25	7,40 USD	10,35 USD
	3	76	8,30 USD	25	9,00 USD	16,00 USD
		96	12,10 USD	25	-	-
Gri	4	102	12,10 USD	25	13,00 USD	25,50 USD
		5	120	22,00 USD	25	25,00 USD
	-	150	30,00 USD	25	35,00 USD	45,00 USD
		180	45,00 USD	25	45,00 USD	55,00 USD

3/1 İÇİ YAPIŞKANLI DARALAN MAKARON



İnc	Ölçü		Uygulama Sonrası			Metre Fiyatı (\$)	Makara (m)
	mm	Daralmadan Önce İç Çap (mm)	Daralmadan Sonra İç Çap (mm)	Yapışkanın Cidar Kalınlığı (mm)	Toplam Cidar Kalınlığı (mm)		
3/32	2.4	2.4	0.8	0,40 ± 0,10	0,85 ± 0,15	0,65 USD	200 m
1/8	3.2	3.2	1,0	0,40 ± 0,10	0,95 ± 0,15	0,65 USD	200 m
3/16	4.8	4.8	1,6	0,40 ± 0,10	1,10 ± 0,15	0,80 USD	100 m
1/4	6.4	6.4	2,2	0,45 ± 0,12	1,20 ± 0,15	1,15 USD	100 m
3/8	9.5	9.5	3,2	0,50 ± 0,12	1,45 ± 0,20	1,70 USD	50 m
1/2	12.7	12.7	4,2	0,50 ± 0,12	1,70 ± 0,20	2,20 USD	1.22 Boy
5/8	16	16	5,5	0,55 ± 0,15	1,80 ± 0,20	3,00 USD	1.22 Boy
3/4	19.1	19.1	6,3	0,55 ± 0,15	2,00 ± 0,20	4,50 USD	1.22 Boy
1	25.4	25.4	8,5	0,60 ± 0,15	2,10 ± 0,25	4,60 USD	1.22 Boy
-	28	28	10,0	0,60 ± 0,15	2,20 ± 0,25	5,10 USD	1.22 Boy
1-1/4	30	30	10,2	0,60 ± 0,15	2,20 ± 0,25	5,50 USD	1.22 Boy
-	33	33	11,0	0,60 ± 0,15	2,20 ± 0,25	5,70 USD	1.22 Boy
-	40	40	13,3	0,60 ± 0,15	2,40 ± 0,25	6,50 USD	1.22 Boy
-	44	44	14,6	0,60 ± 0,15	2,40 ± 0,25	7,20 USD	1.22 Boy
-	52	52	17,3	0,70 ± 0,15	2,70 ± 0,25	8,00 USD	1.22 Boy
-	70	70	23,3	1,00 ± 0,20	3,00 ± 0,30	11,30 USD	1.22 Boy
7/2	90	90	30,0	1,00 ± 0,20	3,00 ± 0,30	16,00 USD	1.22 Boy
5	125	125	41,6	1,00 ± 0,20	3,00 ± 0,30	25,00 USD	1.22 Boy

Baraya Uygun Makaron Çap Hesabı

$$\frac{50+50+10+10}{\pi : 3,14} = 40\text{mm}$$

$$\frac{A1+A2+B1+B2}{\pi : 3,14} = \emptyset$$

* Siparişinizde makaron rengi belirtiniz.
* Kullandığınız üründe radius var ise hesaplamanızı gözden geçirin.

2.5 KV CAM ELYAF MAKARONLAR



BEYAZ ÜZERİ
ÇİZGİLİ - SİYAH



İzolasyon Sınıfı: 8
Çalışma Sıcaklığı:
-25 °C / 130 °C

ÜRÜN KODU	Çap (mm)	Metre Fiyatı (\$)	Rulo (m)
FG-VG 0.70	0.70	0,095 \$	100
FG-VG 1.00	1.00	0,100 \$	100
FG-VG 1.50	1.50	0,125 \$	100
FG-VG 2.00	2.00	0,140 \$	100
FG-VG 2.50	2.50	0,155 \$	100
FG-VG 3.00	3.00	0,170 \$	100
FG-VG 4.00	4.00	0,230 \$	100
FG-VG 5,00	5,00	0,390 \$	100
FG-VG 6.00	6.00	0,450 \$	50
FG-VG 7.00	7.00	0,480 \$	50
FG-VG 8.00	8.00	0,560 \$	50
FG-VG 10.00	10.00	0,770 \$	50
FG-VG 12.00	12.00	0,980 \$	50
FG-VG 14.00	14.00	1,180 \$	50
FG-VG 16.00	16.00	1,700 \$	50
FG-VG 18.00	18.00	1,900 \$	50
FG-VG 20.00	20.00	2,500 \$	25
FG-VG 25.00	25.00	3,950 \$	25

2.5 KV H CLASS CAM-SİLİKON MAKARONLAR



KIRMIZI - SİYAH



İzolasyon Sınıfı:
H Class
Çalışma Sıcaklığı:
-60 °C / 230 °C

ÜRÜN KODU	Çap (mm)	Metre Fiyatı (\$)	Rulo (m)
FG-SRG 0.70	0.70	0,315 \$	100
FG-SRG 1.00	1.00	0,315 \$	100
FG-SRG 1.50	1.50	0,345 \$	100
FG-SRG 2.00	2.00	0,375 \$	100
FG-SRG 2.50	2.50	0,450 \$	100
FG-SRG 3.00	3.00	0,660 \$	100
FG-SRG 3.50	3.50	0,750 \$	100
FG-SRG 4.00	4.00	0,825 \$	100
FG-SRG 5.00	5.00	0,938 \$	100
FG-SRG 6.00	6.00	1,125 \$	100
FG-SRG 7.00	7.00	1,500 \$	100
FG-SRG 8.00	8.00	1,725 \$	100
FG-SRG 10.00	10.00	2,235 \$	100
FG-SRG 12.00	12.00	3,000 \$	50
FG-SRG 14.00	14.00	4,125 \$	50
FG-SRG 16.00	16.00	4,875 \$	50
FG-SRG 18.00	18.00	5,813 \$	50
FG-SRG 20.00	20.00	7,463 \$	25
FG-SRG 25.00	25.00	13,088 \$	25

KABLO TOPLAMA ÇORABI

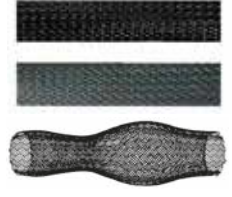

ÜRÜN KODU	Min. Tutma Çapı	Max. Tutma Çapı	Rulo (m)	Renk	Metre Fiyatı (\$)	Renkli Metre Fiyatı (\$)
PE - HB 3 - 8	3	8	100		0,330 \$	0,413 \$
PE - HB 5 - 10	5	10	100		0,330 \$	0,413 \$
PE - HB 6 - 11	6	11	100		0,390 \$	0,488 \$
PE - HB 8 - 12	8	12	100		0,540 \$	0,675 \$
PE - HB 10 - 15	10	15	100		0,600 \$	0,750 \$
PE - HB 12 - 19	12	19	100	●	0,750 \$	0,938 \$
PE - HB 15 - 27	15	27	100	●	0,810 \$	1,013 \$
PE - HB 20 - 28	20	28	100		1,080 \$	1,350 \$
PE - HB 25 - 34	25	34	100		1,350 \$	1,688 \$
PE - HB 30 - 37	30	37	100		1,800 \$	2,250 \$
PE - HB 40 - 45	40	45	100		2,400 \$	3,000 \$
PH - HB 50 - 65	50	65	100		3,150 \$	3,938 \$

KABLO TOPLAMA SİRALLERİ



ÜRÜN KODU	EBAT	Metre Fiyatı (\$)	Rulo (m)
EMTİ - TTSPR8	8 mm Siyah	Ⓢ	5
EMTİ - TTSPR15	15 mm Siyah		5
EMTİ - TTSPR20	20 mm Siyah		5
EMTİ - TTSPR 25	25 mm Siyah		5
EMTİ - TTSPR32	32 mm Siyah		5

HELEZON PANO SİRALLERİ



ÜRÜN KODU	İÇ ÇAP (mm)	DIŞ ÇAP (mm)	Metre Fiyatı (\$)	Rulo (m)
EMTİ - TSPR6	4.1	6.2	Ⓢ	10
EMTİ - TSPR8	6.0	8.0		10
EMTİ - TSPR10	7.5	10.0		10
EMTİ - TSPR12	9.0	12.0		10
EMTİ - TSPR15	12.0	15.0		10



OTOMATİK POMPA KONTROL CİHAZLARI



SU SEVİYE FLATÖRLERİ (TTR) KABLOLU



PRESOSTATLAR



SU SEVİYE FLATÖRLERİ (NMJ KAUÇUK) KABLOLU



MONOFAZE BASINÇ ŞALTERLERİ



40° ve 90° ATIK SIVI SEVİYE FLATÖRLERİ



TRİFAZE BASINÇ ŞALTERLERİ



SU SEVİYE ŞALTERLERİ (250 V, AC, SWITCHLİ)



KONTAKLI SU SEVİYE ŞALTERLERİ (250 V, AC)



SIVI SEVİYE ELEKTROTU





AKILLI KONTROL SİSTEMLERİ



RF UZAKTAN KONTROL ÜNİTELERİ



ELEKTRONİK BALANSLAR



DİMMER GRUPLARI



PANO AYDINLATMA İÇİN LEDLİ BANT ARMATÜR



Pcb Klemensli,
Aç-Kapa Anahtarlı, Miknatıslı

ÜRÜN KODU	GÜÇ	EBATLAR	IŞIK AKISI	ADET (t)
EPL-25037	5 W	200 x 30 x 38 mm	450 lm	8,40 \$
EPL-25067	9 W	200 x 30 x 38 mm	810 lm	9,60 \$
EPL-25097	12 W	400 x 30 x 38 mm	1080 lm	10,80 \$
EPL-25187	20 W	600 x 30 x 38 mm	1800 lm	14,40 \$
EPL-25367	40 W	1200 x 30 x 38 mm	5600 lm	24,00 \$

LEDLİ BANT ARMATÜR



120 cm Kablo Çıkışı



ÜRÜN KODU	GÜÇ	EBATLAR	IŞIK AKISI	ADET (t)
EPL-15037	5 W	200 x 30 x 38 mm	450 lm	8,40 \$
EPL-15067	9 W	200 x 30 x 38 mm	810 lm	9,60 \$
EPL-15097	12 W	400 x 30 x 38 mm	1080 lm	10,80 \$
EPL-15187	20 W	600 x 30 x 38 mm	1800 lm	14,40 \$
EPL-15367	40 W	1200 x 30 x 38 mm	5600 lm	24,00 \$

ASANSÖR KUYU AYDINLATMA SİSTEMİ



Çift Yönlü Bağlantı



ÜRÜN KODU	GÜÇ	EBATLAR	IŞIK AKISI	ADET (t)
EPL-35037	5 W	200 x 30 x 38 mm	450 lm	8,40 \$
EPL-35067	9 W	200 x 30 x 38 mm	810 lm	9,60 \$
EPL-35097	12 W	400 x 30 x 38 mm	1080 lm	10,80 \$
EPL-35187	20 W	600 x 30 x 38 mm	1800 lm	14,40 \$
EPL-35367	40 W	1200 x 30 x 38 mm	5600 lm	24,00 \$

HAZIR TESİSAT İÇİN ARA KABLO



ÜRÜN KODU	UZUNLUK	KESİT	ADET (t)
EK-03	3 Metre	2 x 0,75 mm	3,40 \$
EK-05	5 Metre	2 x 0,75 mm	4,40 \$

YASSI LED BANT ARMATÜR



Genel İç Mekan, Kabin, Makina Dairesi, Kuyu Dibi Aydınlatması İçin

ÜRÜN KODU	GÜÇ	UZUNLUK	IŞIK AKISI	ADET (t)
EPF-15187	18 W	60 cm	1620 lm	Ⓢ
EPF-15367	36 W	120 cm	3240 lm	

PANO İÇİ LED AYDINLATMA

- Alüminyum Gövde
- Plastik Geçme Ayaklarla Kolay Montaj
- Değişken Ölçülerde ve Voltajlarda Üretim İmkanı
- Aydınlatma Led Tipi ve Farklı Renk Seçenekleri (Beyaz, Günışığı, Kırmızı, Yeşil, Mavi)

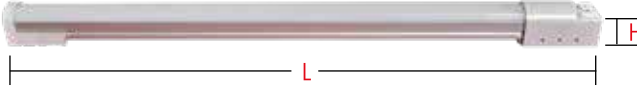
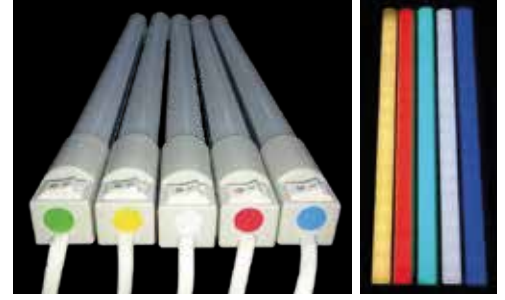

220 / 12 Volt Led Aydınlatma

ÜRÜN KODU	ÜRÜN TANIMI	VOLT	BOY ÖLÇÜSÜ	YÜKSEKLİK ÖLÇÜSÜ	ADET (t)	KOLİ ADEDİ
İR-22025	25 cm Led Pano Aydınlatması	220 Volt	250	23	Ⓢ	50
İR-22035	35 cm Led Pano Aydınlatması	220 Volt	350	23		50
İR-22045	45 cm Led Pano Aydınlatması	220 Volt	450	23		50
İR-22055	55 cm Led Pano Aydınlatması	220 Volt	550	23		50
İR-22060	60 cm Led Pano Aydınlatması	220 Volt	600	23		50

Voltaj : 110/220 V AC	Güç : 5 W	IP : 20
Frekans: 50/60 Hz.	Renk : Beyaz	

12 Volt Led Aydınlatma

ÜRÜN KODU	ÜRÜN TANIMI	VOLT	BOY ÖLÇÜSÜ	YÜKSEKLİK ÖLÇÜSÜ	ADET (t)	KOLİ ADEDİ
İR-12025	25 cm Led Pano Aydınlatması	12 Volt	250	23	Ⓢ	50
İR-12035	35 cm Led Pano Aydınlatması	12 Volt	350	23		50
İR-12045	45 cm Led Pano Aydınlatması	12 Volt	450	23		50
İR-12055	55 cm Led Pano Aydınlatması	12 Volt	550	23		50
İR-12065	65 cm Led Pano Aydınlatması	12 Volt	650	23		50

Voltaj : 12 V AC	Renk : Beyaz
Güç : 4 W	IP : 20

24 Volt Led Aydınlatma

ÜRÜN KODU	ÜRÜN TANIMI	VOLT	BOY ÖLÇÜSÜ	YÜKSEKLİK ÖLÇÜSÜ	ADET (t)	KOLİ ADEDİ
İR-24025	25 cm Led Pano Aydınlatması	24 Volt	250	23	Ⓢ	50
İR-24035	35 cm Led Pano Aydınlatması	24 Volt	350	23		50
İR-24045	45 cm Led Pano Aydınlatması	24 Volt	450	23		50
İR-24055	55 cm Led Pano Aydınlatması	24 Volt	550	23		50
İR-24065	65 cm Led Pano Aydınlatması	24 Volt	650	23		50

Voltaj : 24 V AC	Renk : Beyaz
Güç : 4 W	IP : 20



EL ALETLERİ

%100
YERLİ

TEKNİK BİLGİLER

BAKIR BARA TEKNİK ÖZELLİKLERİ

(ÇEVRE SICAKLIĞI 35 °C ISINMA 30 °C)

BOYUTLAR	KESİT	AĞIRLIK	BOYALI BARA ADEDİ				ÇIPLAK BARA ADEDİ			
			1	2	3	4	1	2	3	4
12x2	23,5	0,209	125	225	-	-	110	200	-	-
15x2	29,5	0,262	155	270	-	-	140	240	-	-
15x3	44,5	0,396	185	330	-	-	170	300	-	-
20x2	39,5	0,351	205	350	-	-	185	315	-	-
20x3	59,5	0,529	245	425	-	-	220	380	-	-
20x5	99,1	0,882	325	560	-	-	295	500	-	-
25x3	74,5	0,663	300	520	-	-	270	460	-	-
25x5	124	1,11	395	670	-	-	350	600	-	-
30x3	89,5	0,796	355	610	-	-	315	540	-	-
30x5	149	1,33	450	780	-	-	400	700	-	-
40x3	119	1	460	790	-	-	420	710	-	-
40x5	199	1,77	600	1000	-	-	520	900	-	-
40x10	399	3,55	850	1500	2060	2800	760	1350	1850	2500
50x5	249	2,22	720	1220	1750	2300	630	1100	1650	2100
50x10	499	4,44	1030	1800	2450	3330	920	1600	2250	3000
60x5	299	2,66	850	1430	1950	2650	760	1250	1760	2400
60x10	599	5,33	1200	2100	2800	3700	1060	1900	2600	3500
80x5	399	3,55	1070	1900	2500	3200	970	1700	2300	3000
80x10	799	7,11	1560	2500	3300	4500	1380	2300	3100	4200
100x5	499	4,44	1350	2300	3000	3800	1200	2050	2850	3500
100x10	999	8,89	1880	3100	4000	5400	1700	2800	3650	5000
120x10	1200	10,7	2200	3500	4500	6100	2000	3100	4100	5700
160x10	1600	14,2	2800	4400	5800	7800	2500	3900	5300	7300
200x10	2000	17,8	3350	5300	6900	9400	3000	4750	6350	8800

PANO İÇİNDE KULLANILAN H05... (NYAF) KABLO TEKNİK ÖZELLİKLERİ

NYAF	Nominal Kesit	Kablo Dış Çapı	Net Ağırlık	Akım Taşıma Kapasitesi (AKIM) 30 °C		Sevki Uzunluğu
	mm ²	mm	kg/km	Boru İçinde	Havada	mt
H05-VK	0,5	2	9	...	12	100
	0,75	2,2	11	...	15	100
	1	2,5	14	...	19	100
H07-VK	1,5	2,8	19	14,5	24	100
	2,5	3,5	30	19,5	32	100
	4	4	44	26	42	100
	6	4,4	62	34	54	100
	10	5,7	110	46	73	100
	16	7,2	167	61	98	100
	25	8,6	262	80	129	100
	35	10,2	350	99	158	1000
	50	12,2	510	119	198	1000
	70	13,9	677	151	245	1000
	95	15,7	891	182	292	1000
	120	17,5	1109	210	344	1000
150	19,2	1371	240	391	1000	
185	21,1	1695	273	448	1000	
240	23,5	320	528	1000

TEKNİK BİLGİLER

TS 3033 EN 60529'a Göre IP Koruma Sınıfları				TS EN 62262 Ye Göre Darbe Koruma Dereceleri	
BİRİNCİ RAKAM	KATI CİSİMLERE KARŞI KORUMA	İKİNCİ RAKAM	KATI MADDELERE KARŞI KORUMA	IK	Darbe Koruma Derecesi
0	Koruma Yok	0	Koruma Yok	00	0
1	50 mm'den büyük boyutlardaki katı cisimlere karşı koruma	1	Dik düşen su damlalarına karşı koruma	01	0,15
2	12,5 mm'den büyük boyutlardaki katı cisimlere karşı koruma	2	Düşey'le 15' lik açı yapan su damlalarına karşı koruma	02	0,20
3	2,5 mm'den büyük boyutlardaki katı cisimlere karşı koruma	3	Düşey'le 60' lik açıdan daha büyük açı oluşturan su damlalarına karşı koruma	03	0,35
4	1 mm'den büyük boyutlardaki katı cisimlere karşı koruma	4	Her yönden gelen su damlalarına karşı koruma	04	0,50
5	Toza karşı koruma	5	Her yönden , hortum marpuçundan püsküren su fişkırtmalarından koruma	05	0,70
6	Toza karşı tam koruma	6	Her yönden şiddetli deniz dalgalarına benzer şekilde çarpan suların etkisine karşı tam koruma	06	1
-	-	7	Suya gömülme durumunda etkilerinden koruma.	07	2
-	-	8	Belirlenmiş koşullar altında uzun sürelerde suya gömülme durumunun etkilerinden koruma	08	5
-	-	-	-	(1)	6
-	-	-	-	09	10
-	-	-	-	10	20

STANDART TERMİNALLERİN AKIM TAŞIMA KAPASİTESİ VE VİDALI TERMİNALLER İÇİN SIKMA TORK CETVELİ

BOYUT (mm ²)	BOYUT AWG/kcmil	AKIM TAŞIMA KAPASİTESİ (AMPER)	VİDA ÖLÇÜSÜ (Metrik)	SIKMA TORKU (Nm)
0,2	24	4	.	.
0,34	22	5	.	.
0,5	20	6	.	.
0,75	18	9	.	.
1	.	13,5	.	.
1,5	16	17,5	2,5	0,4
2,5	14	24	2,5	0,4
4	12	32	3	0,5
6	10	41	3,5	0,8
10	8	57	3,5	0,8
16	6	76	5	2
25	4	101	.	.
35	2	125	5	2
50	0	150	8	6
70	00	192	8	6
95	000	232	8	6
-	0000	-	-	-
120	250 kcmil	269	8	6
150	300 kcmil	309	-	-
185	350 kcmil	353	-	-
240	500 kcmil	425	-	-
300	600 kcmil	520	-	-

BEYAN BAĞLAMA KAPASİTELERİ (EN 60947-7-1 / 8.3.3.2)

ÜRÜN ADI	Çok damarlı min. iletken kesiti yüksüksüz	Çok damarlı max. iletken kesiti yüksüksüz	Çok damarlı min. iletken kesiti yüksüklü	Çok damarlı max. iletken kesiti yüksüklü	Tek damarlı min. iletken kesiti	Tek damarlı max. iletken kesiti	2 iletken, çok damarlı çiftli yüksüklü
MRK 1.5 mm ²	0.34 mm ²	2.5 mm ²	0.34 mm ²	2.5 mm ²	0.50 mm ²	2.5 mm ²	2x0.75 mm ²
MRK 2.5 mm ²	0.34 mm ²	4 mm ²	0.34 mm ²	4 mm ²	0.50 mm ²	4 mm ²	2x0.75 mm ²
MRK 4 mm ²	0.34 mm ²	6 mm ²	0.34 mm ²	6 mm ²	0.50 mm ²	6 mm ²	2x0.75 mm ²
MRK 6 mm ²	1.5 mm ²	10 mm ²	0.34 mm ²	10 mm ²	1.5 mm ²	10 mm ²	...
MRK 10 mm ²	0.75 mm ²	16 mm ²	0.34 mm ²	16 mm ²	1 mm ²	16 mm ²	2x4 mm ²
MRK 16 mm ²	1.5 mm ²	25 mm ²	0.34 mm ²	16 mm ²	1 mm ²	25 mm ²	2x6 mm ²
MRK 25 mm ²	1.5 mm ²	25 mm ²	0.34 mm ²	16 mm ²	1 mm ²	25 mm ²	2x6 mm ²
MRK 35 mm ² (YÜKSEK TİP)	10 mm ²	50 mm ²	4 mm ²	35 mm ²	4 mm ²	35 mm ²	2x16 mm ²
MRK 50 mm ²	16 mm ²	70 mm ²	6 mm ²	50 mm ²	10 mm ²	70 mm ²	2x16 mm ²
MRK 70 mm ²	16 mm ²	95 mm ²	6 mm ²	95 mm ²	16 mm ²	95 mm ²	2x16 mm ²
MRK 95 mm ²	25 mm ²	120 mm ²	10 mm ²	95 mm ²	16 mm ²	120 mm ²	2x16 mm ²
MRK 120 mm ²	35 mm ²	120 mm ²	16 mm ²	120 mm ²	25 mm ²	2x16 mm ²
MRK 2.5 mm ² SLİM	0.34 mm ²	2.5 mm ²	0.34 mm ²	2.5 mm ²	0.50 mm ²	4 mm ²	2x1 mm ²
MRK 4 mm ² SLİM	0.34 mm ²	4 mm ²	0.34 mm ²	4 mm ²	0.50 mm ²	4 mm ²	2x1.5 mm ²
MRK 35 mm ²	10 mm ²	50 mm ²	4 mm ²	35 mm ²	4 mm ²	35 mm ²	2x16 mm ²
MRK-C 2.5 mm ²	0.34 mm ²	4 mm ²	0.34 mm ²	4 mm ²	0.50 mm ²	4 mm ²	2x1 mm ²
MRK-C 4 mm ²	0.34 mm ²	6 mm ²	0.34 mm ²	6 mm ²	0.50 mm ²	6 mm ²	2x1.5 mm ²
MRK-S 6 mm ²	0.34 mm ²	10 mm ²	0.34 mm ²	10 mm ²	0.50 mm ²	10 mm ²	2x2.5 mm ²
EK ALMA KLEMENSİ (18 mm)	0.34 mm ²	16 mm ²	0.34 mm ²	16 mm ²	0.50 mm ²	16 mm ²	...
EK ALMA KLEMENSİ (23 mm)	0.34 mm ²	16 mm ²	0.34 mm ²	16 mm ²	0.50 mm ²	16 mm ²	...
MRK 6 mm ² TEST KLEMENSİ	0.75 mm ²	10 mm ²	0.34 mm ²	10 mm ²	0.50 mm ²	10 mm ²	2x2.5 mm ²
MRK 6 mm ² ÖLÇME-AYIRMA	1 mm ²	10 mm ²	0.34 mm ²	10 mm ²	0.50 mm ²	10 mm ²	2x2.5 mm ²
MRK 10 mm ² ÖLÇME-AYIRMA	0.75 mm ²	16 mm ²	0.34 mm ²	10 mm ²	0.50 mm ²	16 mm ²	2x4 mm ²
MTK 2.5 mm ²	0.34 mm ²	4 mm ²	0.34 mm ²	4 mm ²	0.50 mm ²	4 mm ²	2x1 mm ²
MTK 4 mm ²	0.34 mm ²	6 mm ²	0.34 mm ²	6 mm ²	0.50 mm ²	6 mm ²	2x1.5 mm ²
MTK 10 mm ²	2.5 mm ²	16 mm ²	0.34 mm ²	16 mm ²	1 mm ²	16 mm ²	2x4 mm ²
MTK 16 mm ²	2.5 mm ²	25 mm ²	0.5 mm ²	16 mm ²	2.5 mm ²	25 mm ²	2x6 mm ²
MTK 25 mm ²	2.5 mm ²	25 mm ²	0.5 mm ²	16 mm ²	2.5 mm ²	25 mm ²	2x6 mm ²
MTK 35 mm ² (KISA TİP)	10 mm ²	50 mm ²	4 mm ²	35 mm ²	4 mm ²	35 mm ²	2x16 mm ²
MTK 35 mm ²	10 mm ²	50 mm ²	4 mm ²	35 mm ²	4 mm ²	35 mm ²	2x16 mm ²
OPK 1.5 mm ²	0.34 mm ²	2.5 mm ²	0.34 mm ²	2.5 mm ²	0.50 mm ²	2.5 mm ²	2x0.75 mm ² (İZOLESİZ)
OPK 2.5 mm ²	0.34 mm ²	4 mm ²	0.34 mm ²	4 mm ²	0.50 mm ²	4 mm ²	2x1 mm ² (İZOLESİZ)
OPK 4 mm ²	0.34 mm ²	6 mm ²	0.34 mm ²	4 mm ²	0.50 mm ²	6 mm ²	2x1.5 mm ²
OPK 6 mm ²	0.34 mm ²	10 mm ²	0.34 mm ²	10 mm ² (İZOLESİZ)	0.50 mm ²	10 mm ²	2x2.5 mm ²
OPK 10 mm ²	0.34 mm ²	16 mm ²	0.34 mm ²	16 mm ² (İZOLESİZ)	0.50 mm ²	16 mm ²	2x4 mm ²
OPK 16 mm ²	0.34 mm ²	25 mm ²	0.34 mm ²	25 mm ²	0.50 mm ²	25 mm ²	2x6 mm ²
OPK 35 mm ²	0.34 mm ²	50 mm ²	0.34 mm ²	35 mm ²	0.50 mm ²	50 mm ²	2x10 mm ²
OPK-C 2.5 mm ²	0.34 mm ²	4 mm ²	0.34 mm ²	4 mm ² (İZOLESİZ)	0.50 mm ²	4 mm ²	2x1 mm ² (İZOLESİZ)
OPK-C 4 mm ²	4 mm ²	6 mm ²	0.34 mm ²	6 mm ² (İZOLESİZ)	1.5 mm ²	6 mm ²	2x1.5 mm ² (İZOLESİZ)
OPK-T 2.5 mm ²	1 mm ²	4 mm ²	0.34 mm ²	4 mm ² (İZOLESİZ)	0.50 mm ²	4 mm ²	2x1 mm ² (İZOLESİZ)
OPK-T 4 mm ²	4 mm ²	6 mm ²	0.34 mm ²	6 mm ² (İZOLESİZ)	1.5 mm ²	6 mm ²	2x1.5 mm ² (İZOLESİZ)
OPK-2.5 mm ²	0.34 mm ²	4 mm ²	0.34 mm ²	4 mm ² (İZOLESİZ)	0.50 mm ²	4 mm ²	2x1 mm ² (İZOLESİZ)
OPK 2.5 mm ² (1GİRİŞ-2ÇIKIŞ)	1.5 mm ²	4 mm ²	0.34 mm ²	4 mm ² (İZOLESİZ)	0.50 mm ²	4 mm ²	2x1 mm ² (İZOLESİZ)
OPK 2.5 mm ² (2GİRİŞ-2ÇIKIŞ)	0.34 mm ²	4 mm ²	0.34 mm ²	4 mm ² (İZOLESİZ)	0.50 mm ²	4 mm ²	2x1 mm ² (İZOLESİZ)
OPK 2.5 mm ² TEST (2GİRİŞ-2ÇIKIŞ)	1.5 mm ²	4 mm ²	0.34 mm ²	4 mm ² (İZOLESİZ)	0.50 mm ²	4 mm ²	2x1 mm ² (İZOLESİZ)
OTK 4 mm ²	1 mm ²	6 mm ²	0.34 mm ²	6 mm ²	0.50 mm ²	6 mm ²	2x1.5 mm ² (İZOLESİZ)
OTK 10 mm ²	0.5 mm ²	16 mm ²	0.34 mm ²	16 mm ² (İZOLESİZ)	0.50 mm ²	16 mm ²	2x4 mm ² (İZOLESİZ)
MPK 2.5 mm ²	0.34 mm ²	4 mm ²	0.34 mm ²	4 mm ² (İZOLESİZ)	0.50 mm ²	4 mm ²	2x1 mm ² (İZOLESİZ)
MP 2.5 mm ²	2.5 mm ²	4 mm ²	0.34 mm ²	4 mm ² (İZOLESİZ)	0.50 mm ²	4 mm ²	2x1 mm ² (İZOLESİZ)
MPK(T)2.5 mm ²	0.75 mm ²	4 mm ²	0.34 mm ²	4 mm ² (İZOLESİZ)	1 mm ²	4 mm ²	2x1 mm ² (İZOLESİZ)
HRK 2,5 mm ²	0.75 mm ²	4 mm ²	0.34 mm ²	4 mm ² (İZOLESİZ)	0.50 mm ²	4 mm ²	2x1 mm ² (İZOLESİZ)
HRK 6 mm ²	2.5 mm ²	10 mm ²	0.5 mm ²	6 mm ²	1.50 mm ²	10 mm ²	2x2.5 mm ²
MRK 3 KATLI 2.5mm ²	0.34 mm ²	4 mm ²	0.34 mm ²	4 mm ²	0.50 mm ²	4 mm ²	2x0.75 mm ²
MRK MOTOR KLEMENS 2.5mm ²	0.34 mm ²	4 mm ²	0.34 mm ²	4 mm ²	0.50 mm ²	4 mm ²	2x0.75 mm ²
OPK 3 KATLI 2.5mm ² MONOBLOCK	0.34 mm ²	4 mm ²	0.34 mm ²	4 mm ² (İZOLESİZ)	0.50 mm ²	4 mm ²	2x1 mm ²
OPK 3 KATLI 4mm ² MONOBLOCK	0.34 mm ²	6 mm ²	0.34 mm ²	6 mm ² (İZOLESİZ)	0.50 mm ²	6 mm ²	2x1.5 mm ²
OPK 2 KATLI 2.5mm ² MONOBLOCK	0.34 mm ²	4 mm ²	0.34 mm ²	2.5 mm ²	0.50 mm ²	4 mm ²	2x1 mm ²
OPK 2 KATLI 4mm ² MONOBLOCK	0.34 mm ²	6 mm ²	0.34 mm ²	6 mm ² (İZOLESİZ)	0.50 mm ²	6 mm ²	2x1.5 mm ²
PCP 2,5 mm ²	0.34 mm ²	4 mm ²	0.34 mm ²	4 mm ² (İZOLESİZ)	0.50 mm ²	4 mm ²	2x1 mm ² (İZOLESİZ)

Onka®



Onka[®]
ELEKTRİK MALZ. SAN. ve TİC. A.Ş.

ELEKTROKAR[®]
ELEKTRİK MALZEMELERİ SANAYİ ve TİC. A.Ş.

Onka[®]
ELEKTRONİK PAZARLAMA DIŞ TİC. A.Ş.

İnönü Mah. Gebze Plastikçiler OSB
Cumhuriyet Cad. No:27 (41400),
Gebze / KOCAELİ / TÜRKİYE

Tel: +90 262 751 46 55

444 0 921
www.onka.com.tr

Satış Grubu

İstanbul Perpa / Karaköy	+90 530 401 04 14
İstanbul Avrupa Yakası	+90 530 401 04 15
İstanbul Anadolu Yakası	+90 532 486 80 50
Marmara / Trakya Bölgesi	+90 532 592 27 09
Ankara Bölgesi	+90 530 401 04 12
Ege / Akdeniz Bölgesi	+90 530 497 85 95
	+90 530 401 05 02
Adana / G. Doğu Anadolu Bölgesi	+90 530 781 03 59
	+90 534 889 12 67
Doğu Karadeniz / D. Anadolu Bölgesi	+90 530 401 04 13
Konya / İç Anadolu Bölgesi	+90 530 401 04 16

Teknik Destek Departmanı

Teknik Destek: +90 530 497 85 86
teknikdestek@onka.com.tr



Katalog



LinkedIn