



GÜVEN

ELEKTRİK ELEKTRONİK LTD. ŞTİ.

GWEST®

WWOER®



2023

TEMMUZ
FİYAT LİSTESİ

İÇİNDEKİLER

Kablo Bağları ve Aksesuarları

Standart Beyaz Kablo Bağları	04
Standart Siyah Kablo Bağları	05
Standart Renkli Kablo Bağları	06
Ultraviöle Kablo Bağları	07
Paslanmaz Çelik Kablo Bağları	08
PVC Kaplı Paslanmaz Çelik Kablo Bağları	09
Etiketli Kablo Bağları	10
Açılabilir Kablo Bağları	10
Distanslı Kablo Bağları	10
Yapışkanlı Kroşeler	11
Kapama Parçası	11
Kablo Kelepçesi	11
Kartuş Yükseltici	12
Beton Kroşe	12
Vidalı Kroşe	12
Kablo Bağı Etiket Taşıyıcı	13
Yapışkanlı Pano Etiket Taşıyıcı	13
Helezon Spiraller	14

Kablo Yüksükleri ve Uçları

İzoleli Kablo Yüksükleri Fransız Normu	16
İzoleli Kablo Yüksükleri Alman Normu	17
Çift Girişli Kablo Yüksükleri Fransız Normu	18
Çift Girişli Kablo Yüksükleri Alman Normu	19
İzolesiz Kablo Yüksükleri	20
Yuvarlak Tip İzoleli Kablo Uçları	22
Çatal Tip İzoleli Kablo Uçları	23
Ek Mufları İzoleli Kablo Uçları	24
Erkek Terminaller İzoleli Kablo Uçları	24
Dişi Terminaller İzoleli Kablo Uçları	24
Dişi Faston Tip İzoleli Kablo Uçları	25
Tam İzoleli Dişi Faston Tip Kablo Uçları	25
Tam İzoleli Polyamid Dişi Faston Tip Kablo Uçları	26
İğne Tip İzoleli Kablo Uçları	26
Erkek / Dişi Geri Dönüştürülebilir Terminaller	26
Erkek Faston Tip Terminaller	27
Tam İzoleli Polyamid Bayrak Tip Terminaller	27
İzolesiz Kablo Ucu ve Konnektörleri	28

Bağlantı Elemanları

SKP Eko Tip Kablo Pabucu	30
SKP Eko Tip Kablo Pabucu	31
SKP Standart Tip Kablo Pabucu	32
SKP Standart Tip Kablo Pabucu	33
DIN 46235 Tip Kablo Pabucu	34
DIN 46235 Tip Kablo Pabucu	35
Bimetal (AL-CU) Kablo Pabucu	36
Ek Mufları	37
Delikli Montaj Rayları	38
Düz Montaj Rayları	38
Monofaze Müşterek W Otomat Baraları	39
Trifaze Müşterek W Otomat Baraları	39
2 Kutuplu Dağıtıcı Üniteler	40
4 Kutuplu Dağıtıcı Üniteler	41
Tek Kutuplu Dağıtıcı Üniteler	42
Tek Kutuplu Dağıtıcı Üniteler	43

Kompakt Çok Amaçlı Klemensler

Geçmeli Buat Klemens	45
Çok Amaçlı Klemens	45

Makaron Grubu ve Bant Çeşitleri

Isı ile Daralan Siyah Makaronlar	47
Isı ile Daralan Renkli Makaronlar	48
Isı ile Daralan Kahverengi Makaronlar	49
Isı ile Daralan Sarı / Yeşil Makaronlar	50
İçi Yapışkanlı Daralan Makaronlar	51
Kablo Toplama Çorabı	52
H Class Cam Elyaf Silikon İzoleli Makaronlar	53

İÇİNDEKİLER

Mekanik ve Hidrolik El Aletleri

Yüksük Sıkma Penseleri	55
İzolesiz Kablo Ucu ve Konnektör Sıkma Penseleri	56
İzoleli Kablo Ucu Sıkma Penseleri	56
Multi Fonksiyonel Yüksük ve Kablo Ucu Sıkma Pensesi..	57
Kablo Sıyırma Pensesi	57
Kablo Bağı Sıkma Penseleri	57
Kablo Pabucu Sıkma Penseleri	58
Hidrolik Sıkma ve Kesme Penseleri	58
Kablo Kesme Makasları	59

Buton Serisi ve Aksesuarları

Yaylı Butonlar	61
İşaretleli Yaylı Butonlar	61
İşikly Yaylı Butonlar	61
Kalıcı Mandal Butonlar	62
Kayıcı Mandal Butonlar	62
Kalıcı - Kayıcı Mandal Butonlar	62
Anahtarlı Kalıcı Butonlar	62
İşikly Kalıcı Mandal Butonlar	63
40mm Kalıcı Mantar Butonlar	64
40mm Kalıcı Anahtarlı Mantar Butonlar	64
40mm Kayıcı Mantar Butonlar	64
40mm Kalıcı Mantar Butonlar	64
İkiz Butonlar	64
Buton Serisi Aksesuarları	65
Boş Kumanda Kutuları	66
Kutulu Acil Stop Buton	66
Vinç Kumandaları	67
Acil Stoplu Vinç Kumandaları	67
Ø 22mm Voltmetre	68
Ø 22mm Ampermetre	68
Ø 22mm Led'li Sinyaller	69
Ø 16mm Led'li Sinyaller	69
BA9S Led Ampuller	70
Ø 22mm Led'li Buzzer	71
Motorlu Sirenler	71
Pano İçi Termostatlar	71
Ø 22mm Potansiyometre	72
Aks Serisi Kapı Switch	72

Switch Grubu

GLS Serisi Limit Switch	74
GLS Serisi Limit Switch	75
GLS Serisi Limit Switch	76
GLS Serisi Limit Switch	77
AZ Serisi Mikro Switch	78
AZ Serisi Mikro Switch	79
AZ Serisi Mikro Switch	80
GMS Serisi Mikro Switch	81

Ayak Pedalları

Metal Döküm Pedal	82
Alüminyum Döküm Pedal	82



Bu fiyat listesindeki tipografik baskı hatalarından firmamız sorumlu değildir. Firmamız fiyat listesinde yayınlanmış olduđu teknik özellikleri deđiřtirme, döviz ve hammadde artışlarından dolayı meydana gelebilecek fiyat artışlarını hiçbir uyarıda bulunmaksızın fiyat listesine yansıtma hakkına sahiptir.

Kalite Belgelerimiz

Güven Elektrik olarak, müşteri odaklı yaklaşımımızla, sağladığımız tüm ürün ve hizmetlerde müşteri memnuniyetini en üst düzeyde tutarak kalite ve uygunluk standartları uyguluyoruz.

Yüksek seviyede ürün kalitesini ve mevzuata uygunluğu korumak temel hedefimizdir.

Kalite, firmamız açısından tartışmasız en önemli unsurdur. En kaliteli ürünleri ortaya çıkarabilmek adına; tüm hammaddelerimizi titizlikle seçmekteyiz.



Bizim Hakkımızda

2004 yılında karaköyde kurulan şirketimiz ürün çeşitliliğini arttırmayı ve bulunmuş olduğu sektörde sahip olduğu GWEST markasını en üst seviyeye taşımayı ilke olarak belirlemiştir. Müşterilerimize daha iyi hizmet sunabilmek için 2014 yılında İkitelli Organize Sanayi Bölgesi merkezine taşınmıştır. 2016 yılında ilk imalat tecrübesini yaşayan firmamız 2021 yılında 3000 m² kapalı alana sahip yeni yerine geçmiştir.

Firmamız uluslararası kalite standartların da gerçekleştirdiği hizmet ve üretimi ISO, CE ve TSE sertifikalarıyla da belgelendirmiştir.

Hedeflerimiz arasında olarak ürettiği ürünlerde yüksek kaliteye ulaşip ürün çeşitliliğini arttırıp ve koşulsuz müşteri memnuniyeti belirlemiştir. Bugüne kadar çalışmış olduğu müşterilerine koşulsuz müşteri memnuniyeti yaşatan Güven Elektrik hizmetlerine kalite standartlarını yükselterek devam etmektedir.



GÜÇLÜ VE DAYANIKLI

YÜKSEK KALİTELİ

Tutarlı Performans ve Güvenilirlik Sağlar.

Çok Çeşitli İç Mekan ve Dış Mekan Uygulama Alanlarında Kullanılır.



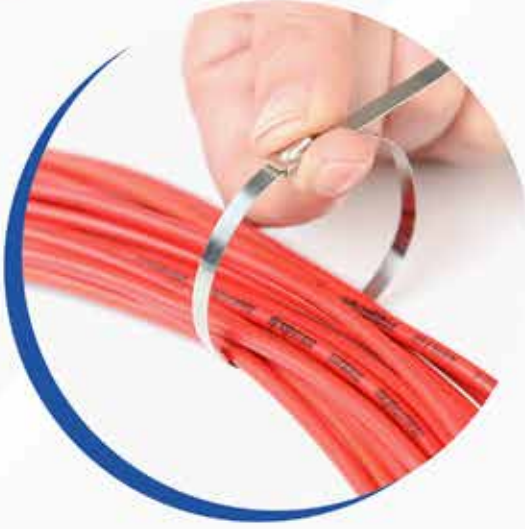

KABLO BAĞLARI

Ve Aksesuarları



STANDART BEYAZ KABLO BAĞLARI

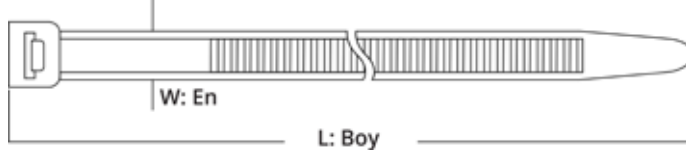

Malzeme : Saf Naylon 6.6 Standart UL
Çalışma Sıcaklığı : - 40 ° C --- +85 ° C

Sipariş Kodu	Ürün Kodu	Boyutlar		Renk	Maksimum Sıkma Çapı (mm)	Açılma Mukavemeti (kg)	Ambalaj Adet		Birim Fiyat TL / Adet
		Uzunluk (mm)	En (mm)				Paket	Koli	
1001	GT 100 M	100	2.5	Beyaz	20	8	1.000	65.000	0.210
1002	GT 150 M	150		Beyaz	36		1.000	50.000	0.320
1003	GT 200 M	200		Beyaz	52		1.000	35.000	0.460
1004	GT 150 I	150	3.6	Beyaz	36	18	100	23.000	0.540
1005	GT 200 I	200		Beyaz	52		100	18.000	0.710
1006	GT 250 I	250		Beyaz	68		100	18.000	0.850
1007	GT 300 I	300		Beyaz	84		100	15.000	1.080
1008	GT 370 I	370		Beyaz	106		100	12.000	1.360
1009	GT 200 ST	200	4.8	Beyaz	50	22	100	13.000	1.000
1010	GT 250 ST	250		Beyaz	65		100	12.000	1.230
1011	GT 300 ST	300		Beyaz	81		100	11.000	1.480
1012	GT 370 ST	370		Beyaz	104		100	9.000	1.720
1050	GT 400 ST	400		Beyaz	113		100	6.500	1.970
1013	GT 430 ST	430		Beyaz	123		100	6.000	2.300
1015	GT 300 HD	300	7.6	Beyaz	76	55	100	5.000	2.930
1016	GT 370 HD	370		Beyaz	102		100	4.000	3.300
1017	GT 430 HD	430		Beyaz	110		100	3.000	3.900
1018	GT 530 HD	530		Beyaz	140		100	2.000	5.000
1019	GT 610 HD	610		Beyaz	185		100	2.000	5.600
1020	GT 750 HD	750		Beyaz	226		100	2.000	7.600
1022	GT 710 HD	710	9	Beyaz	190	80	100	2.000	8.250
1023	GT 780 HD	780		Beyaz	228		100	2.000	10.00
1024	GT 920 HD	920		Beyaz	280		100	1.000	11.30
1025	GT 1020 HD	1020		Beyaz	295		100	1.000	11.80
1026	GT 1220 HD	1220		Beyaz	375		100	1.000	15.00

STANDART SİYAH KABLO BAĞLARI

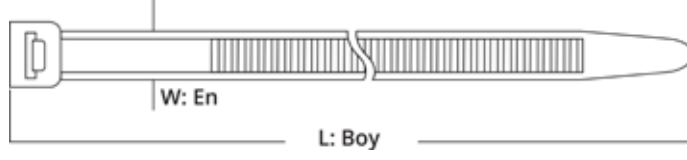

Malzeme : Saf Naylon 6.6 Standart UL
Çalışma Sıcaklığı : - 40 ° C --- +85 ° C

Sipariş Kodu	Ürün Kodu	Boyutlar		Renk	Maksimum Sıkma Çapı (mm)	Açılma Mukavemeti (kg)	Ambalaj Adet		Birim Fiyat TL / Adet
		Uzunluk (mm)	En (mm)				Paket	Koli	
1027	GT 100 MB	100	2.5	Siyah	20	8	1.000	65.000	0.210
1028	GT 150 MB	150		Siyah	36		1.000	50.000	0.320
1029	GT 200 MB	200		Siyah	52		1.000	35.000	0.460
1030	GT 150 IB	150	3.6	Siyah	36	18	100	23.000	0.540
1031	GT 200 IB	200		Siyah	52		100	18.000	0.710
1032	GT 250 IB	250		Siyah	68		100	18.000	0.850
1033	GT 300 IB	300		Siyah	84		100	15.000	1.080
1034	GT 370 IB	370		Siyah	106		100	12.000	1.360
1035	GT 200 STB	200	4.8	Siyah	50	22	100	13.000	1.000
1036	GT 250 STB	250		Siyah	65		100	12.000	1.230
1037	GT 300 STB	300		Siyah	81		100	11.000	1.480
1038	GT 370 STB	370		Siyah	104		100	9.000	1.720
1039	GT 430 STB	430		Siyah	123		100	6.000	2.300
1041	GT 300 HDB	300	7.6	Siyah	76	55	100	5.000	2.930
1042	GT 370 HDB	370		Siyah	102		100	4.000	3.300
1043	GT 430 HDB	430		Siyah	110		100	3.000	3.900
1044	GT 530 HDB	530		Siyah	140		100	2.000	5.000
1045	GT 610 HDB	610		Siyah	185		100	2.000	5.600
1048	GT 710 HDB	710	9	Siyah	190	80	100	2.000	8.250
1049	GT 780 HDB	780		Siyah	228		100	2.000	10.00

STANDART RENKLİ KABLO BAĞLARI

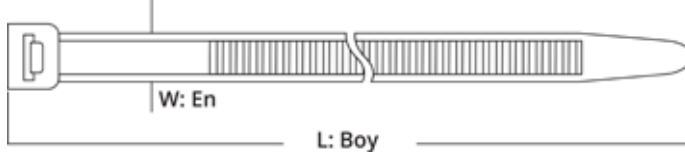

Malzeme : Saf Naylon 6.6 Standart UL
Çalışma Sıcaklığı: - 40 ° C --- +85 ° C

Sipariş Kodu	Ürün Kodu	Boyutlar		Renk	Maksimum Sıkma Çapı (mm)	Açılma Mukavemeti (kg)	Ambalaj Adet		Birim Fiyat TL / Adet
		Uzunluk (mm)	En (mm)				Paket	Koli	
1101	GT 100 MK	100	2.5	Kırmızı	20	8	1.000	65.000	0.220
1102	GT 150 IK	150	3.6	Kırmızı	36	18	100	23.000	0.530
1103	GT 200 IK	200		Kırmızı	52		100	18.000	0.750
1104	GT 250 IK	250		Kırmızı	68		100	18.000	0.860
1105	GT 300 IK	300		Kırmızı	84		100	15.000	1.100
1106	GT 200 STK	200		Kırmızı	50		22	100	13.000
1107	GT 250 STK	250	Kırmızı	65	100	12.000		1.250	
1108	GT 300 STK	300	Kırmızı	81	100	11.000		1.500	
1109	GT 370 STK	370	Kırmızı	101	100	9.000		1.800	
1110	GT 100 MM	100	2.5	Mavi	20	8		1.000	65.000
1111	GT 150 IM	150	3.6	Mavi	36	18	100	23.000	0.530
1112	GT 200 IM	200		Mavi	52		100	18.000	0.750
1113	GT 250 IM	250		Mavi	68		100	18.000	0.860
1114	GT 300 IM	300		Mavi	84		100	15.000	1.100
1115	GT 200 STM	200		Mavi	50		22	100	13.000
1116	GT 250 STM	250	Mavi	65	100	12.000		1.250	
1117	GT 300 STM	300	Mavi	81	100	11.000		1.500	
1118	GT 370 STM	370	Mavi	101	100	9.000		1.800	
1119	GT 100 MS	100	2.5	Sarı	20	8		1.000	65.000
1120	GT 150 IS	150	3.6	Sarı	36	18	100	23.000	0.530
1121	GT 200 IS	200		Sarı	52		100	18.000	0.750
1122	GT 250 IS	250		Sarı	68		100	18.000	0.860
1123	GT 300 IS	300		Sarı	84		100	15.000	1.100
1124	GT 200 STS	200		Sarı	50		22	100	13.000
1125	GT 250 STS	250	Sarı	65	100	12.000		1.250	
1126	GT 300 STS	300	Sarı	81	100	11.000		1.500	
1127	GT 370 STS	370	Sarı	104	100	9.000		1.800	
1128	GT 100 MY	100	2.5	Yeşil	20	8		1.000	65.000
1129	GT 150 IY	150	3.6	Yeşil	36	18	100	23.000	0.530
1130	GT 200 IY	200		Yeşil	52		100	18.000	0.750
1131	GT 250 IY	250		Yeşil	68		100	18.000	0.860
1132	GT 300 IY	300		Yeşil	84		100	15.000	1.100
1133	GT 200 STY	200		Yeşil	50		22	100	13.000
1134	GT 250 STY	250	Yeşil	65	100	12.000		1.250	
1135	GT 300 STY	300	Yeşil	81	100	11.000		1.500	
1136	GT 370 STY	370	Yeşil	101	100	9.000		1.800	

ULTRAVİOLE KABLO BAĞLARI

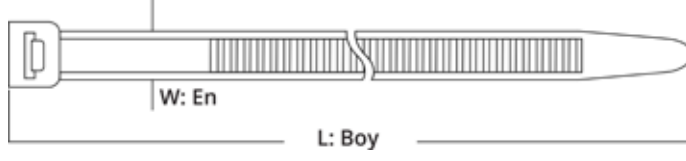

Malzeme : Saf Naylon 6.6 Standart UL
Çalışma Sıcaklığı : - 40 ° C --- +85 ° C

Sipariş Kodu	Ürün Kodu	Boyutlar		Renk	Maksimum Sıkma Çapı (mm)	Açılma Mukavemeti (kg)	Ambalaj Adet		Birim Fiyat TL / Adet
		Uzunluk (mm)	En (mm)				Paket	Koli	
1201	GT 100 M UV	100	2.5	Siyah	20	8	1.000	65.000	0.230
1202	GT 150 M UV	150		Siyah	36		1.000	50.000	0.350
1203	GT 200 M UV	200		Siyah	52		1.000	35.000	0.500
1204	GT 150 I UV	150	3.6	Siyah	36	18	100	23.000	0.550
1205	GT 200 I UV	200		Siyah	52		100	18.000	0.780
1206	GT 250 I UV	250		Siyah	68		100	18.000	0.950
1207	GT 300 I UV	300		Siyah	84		100	15.000	1.150
1208	GT 200 ST UV	200	4.8	Siyah	50	22	100	13.000	1.050
1209	GT 250 ST UV	250		Siyah	65		100	12.000	1.300
1210	GT 300 ST UV	300		Siyah	81		100	11.000	1.600
1211	GT 370 ST UV	370		Siyah	104		100	9.000	1.900
1212	GT 430 ST UV	430		Siyah	123		100	6.000	2.500
1213	GT 300 HD UV	300	7.6	Siyah	76	55	100	5.000	3.200
1214	GT 370 HD UV	370		Siyah	102		100	4.000	3.600
1215	GT 430 HD UV	430		Siyah	110		100	3.000	4.000
1216	GT 530 HD UV	530		Siyah	140		100	2.000	5.400
1217	GT 780 HD UV	780	9	Siyah	228	80	100	2.000	11.00



PASLANMAZ ÇELİK KABLO BAĞLARI

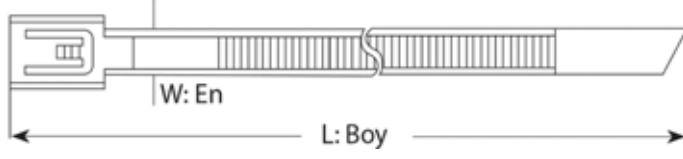

Malzeme : 304 Paslanmaz Çelik
Su Emilimi: Yok
Alev Yürümeme : UL94V-2

Sipariş Kodu	Ürün Kodu	Boyutlar		Renk	Maksimum Sıkma Çapı (mm)	Açılma Mukavemeti (kg)	Ambalaj Adet		Birim Fiyat TL / Adet
		Uzunluk (mm)	En (mm)				Paket	Koli	
1301	MTL 150 ST	150	4.6	Metal	44	55	100	8.000	3.50
1302	MTL 200 ST	200		Metal	51		100	6.000	3.90
1303	MTL 260 ST	260		Metal	69		100	5.000	4.40
1304	MTL 300 ST	300		Metal	76		100	5.000	4.70
1305	MTL 370 ST	370		Metal	102		100	4.000	5.20
1306	MTL 520 ST	520		Metal	152		100	3.000	6.50
1307	MTL 680 ST	680		Metal	203		100	2.000	8.00
1308	MTL 840 ST	840		Metal	254		100	1.000	9.50
1309	MTL 200 HD	200	7.9	Metal	50	120	100	5.000	6.10
1310	MTL 300 HD	300		Metal	75		100	4.000	7.00
1311	MTL 370 HD	370		Metal	102		100	3.000	8.20
1312	MTL 520 HD	520		Metal	152		100	2.000	10.30
1313	MTL 680 HD	680		Metal	203		100	2.000	12.00
1314	MTL 840 HD	840		Metal	224		100	1.000	15.00

Paslanmaz Çelik Kablo Bağları

- Kendiliğinden kilitlenebilir kafa tasarımı, kurulumu hızlandırır ve kablo bağı gövdesi boyunca herhangi bir boyda kilitlemeyi sağlar.
- Güçlü ve dayanıklı kablo bağlama yöntemini temin eder.
- Çok çeşitli iç mekân ve dış mekân uygulama alanlarında kullanılabilir.
- Pürüzsüz yüzeyi ve yuvarlatılmış uçları ile kablunun korunmasını ve çalışan kişinin güvenliğini garanti eder.
- Şebeke kablolarında en üst düzey desteği sağlar.
- Genel amaçlı uygulamalar için : 304 paslanmaz çelik



PVC KAPLI PASLANMAZ ÇELİK KABLO BAĞLARI

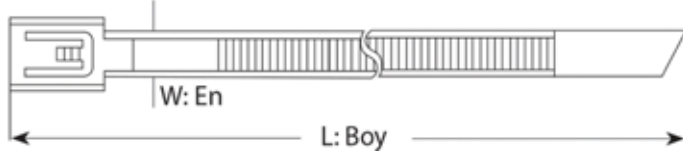

Malzeme : 304 Paslanmaz Çelik
Su Emilimi: Yok
Alev Yürümeme : UL94V-2

Sipariş Kodu	Ürün Kodu	Boyutlar		Renk	Maksimum Sıkma Çapı (mm)	Açılma Mukavemeti (kg)	Ambalaj Adet		Birim Fiyat TL / Adet
		Uzunluk (mm)	En (mm)				Paket	Koli	
1401	PVC MTL 150 ST	150	4.6	Metal	44	55	100	8.000	5.20
1402	PVC MTL 200 ST	200		Metal	51		100	6.000	5.80
1403	PVC MTL 260 ST	260		Metal	69		100	5.000	6.40
1404	PVC MTL 300 ST	300		Metal	76		100	5.000	7.00
1405	PVC MTL 370 ST	370		Metal	102		100	4.000	8.50
1406	PVC MTL 520 ST	520		Metal	152		100	3.000	11.00
1407	PVC MTL 680 ST	680		Metal	203		100	2.000	13.00
1408	PVC MTL 840 ST	840		Metal	254		100	1.000	17.00
1409	PVC MTL 200 HD	200	7.9	Metal	50	120	100	5.000	7.70
1410	PVC MTL 300 HD	300		Metal	75		100	4.000	10.00
1411	PVC MTL 370 HD	370		Metal	102		100	3.000	11.00
1412	PVC MTL 520 HD	520		Metal	152		100	2.000	15.00
1413	PVC MTL 680 HD	680		Metal	203		100	2.000	19.00
1414	PVC MTL 840 HD	840		Metal	224		100	1.000	23.00

PVC Kaplı Paslanmaz Çelik Kablo Bağları

- Kendiliğinden kilitlenebilir kafa tasarımı, kurulumu hızlandırır ve kablo bağı gövdesi boyunca herhangi bir boyda kilitlemeyi sağlar.
- Güçlü ve dayanıklı kablo bağlama yöntemini temin eder.
- Çok çeşitli iç mekân ve dış mekân uygulama alanlarında kullanılabilir.
- Pürüzsüz yüzeyi ve yuvarlatılmış uçları ile kablonun korunmasını ve çalışan kişinin güvenliğini garanti eder.
- Şebeke kablolarında en üst düzey desteği sağlar.
- Genel amaçlı uygulamalar için : 304 paslanmaz çelik



ETİKETLİ KABLO BAĞLARI

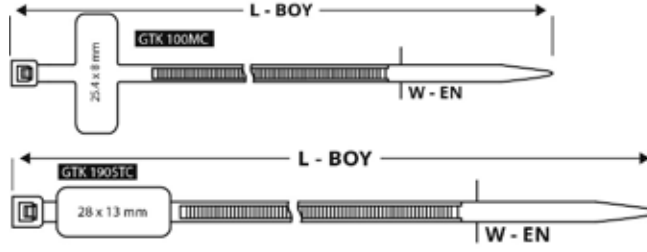

Malzeme : Saf Naylon 6.6 Standart UL
Çalışma Sıcaklığı : - 40 ° C --- +85 ° C

Sipariş Kodu	Ürün Kodu	Boyutlar		Renk	Maksimum Sıkma Çapı (mm)	Açılma Mukavemeti (kg)	Ambalaj Adet		Birim Fiyat TL / Adet
		Uzunluk (mm)	En (mm)				Paket	Koli	
1501	GTK 100 MC	100	2.5	Beyaz	20	8	100	30.000	0.65
1502	GTK 190 STC	190	4.8	Beyaz	48	22	100	12.000	1.50

AÇILABİLİR KABLO BAĞLARI

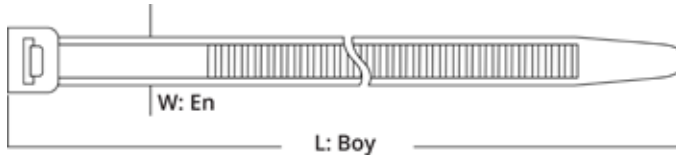

Malzeme : Saf Naylon 6.6 Standart UL
Çalışma Sıcaklığı : - 40 ° C --- +85 ° C

Sipariş Kodu	Ürün Kodu	Boyutlar		Renk	Maksimum Sıkma Çapı (mm)	Açılma Mukavemeti (kg)	Ambalaj Adet		Birim Fiyat TL / Adet
		Uzunluk (mm)	En (mm)				Paket	Koli	
1503	GTA 200 HD	200	7.6	Beyaz	50	36	100	5.000	2.30
1504	GTA 370 HD	370	7.6	Beyaz	100	36	100	3.000	3.90

DİSTANSLI KABLO BAĞLARI

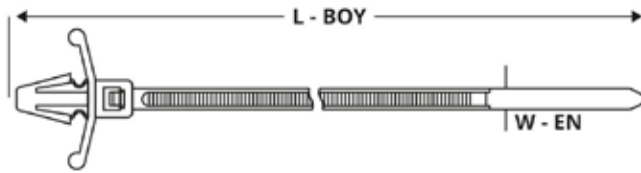

Malzeme : Saf Naylon 6.6 Standart UL
Çalışma Sıcaklığı : - 40 ° C --- +85 ° C

Sipariş Kodu	Ürün Kodu	Boyutlar		Renk	Maksimum Sıkma Çapı (mm)	Açılma Mukavemeti (kg)	Ambalaj Adet		Birim Fiyat TL / Adet
		Uzunluk (mm)	En (mm)				Paket	Koli	
1505	GTP 100 M	100	2.5	Beyaz	20	8	100	50.000	0.65
1506	GTP 150 I	150	3.6	Beyaz	35	18	100	30.000	0.95
1507	GTP 200 ST	200	4.8	Beyaz	50	22	100	12.000	2.00

YAPIŞKANLI KROŞE

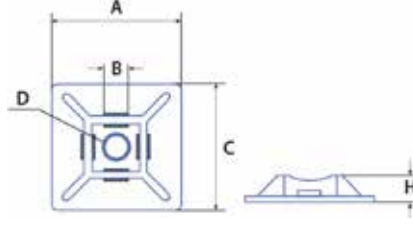

Malzeme : Saf Naylon 6.6 Standart UL
Çalışma Sıcaklığı : - 40 ° C --- +85 ° C

Sipariş Kodu	Ürün Kodu	Boyutlar					Renk	Ambalaj Adet		Birim Fiyat TL / Adet
		A	B	C	D	H		Paket	Koli	
1513	HW - 3A	19	19	3.6	Ø 3.2	4.0	Beyaz	100	20.000	0.90
1514	HW - 4A	28	28	4.8	Ø 3.2	4.5	Beyaz	100	9.000	1.60
1515	HW - 3AB	19	19	3.6	Ø 3.2	4.0	Siyah	100	20.000	0.90
1516	HW - 4AB	28	28	4.8	Ø 3.2	4.5	Siyah	100	9.000	1.60

KAPAMA PARÇASI

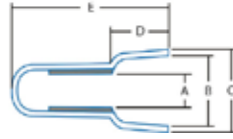
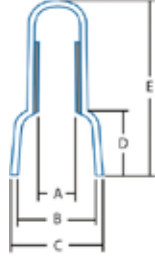

Malzeme : Saf Naylon 6.6 Standart UL
Çalışma Sıcaklığı : - 40 ° C --- +85 ° C

Sipariş Kodu	Ürün Kodu	Boyutlar					Renk	Ambalaj Adet		Birim Fiyat TL / Adet
		A	B	C	D	H		Paket	Koli	
1517	HW - C4	19	19	3.6	Ø 3.2	4.0	Beyaz	100	20.000	0.50
1518	HW - C5	28	28	4.8	Ø 3.2	4.5	Beyaz	100	10.000	0.90

KABLO KELEPÇESİ

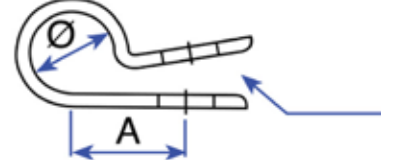
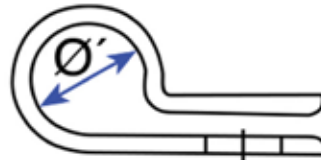
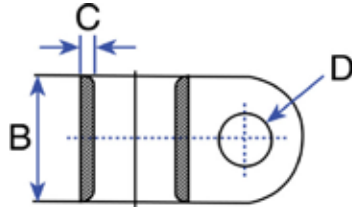

Sipariş Kodu	Ürün Kodu	Boyutlar						Renk	Ambalaj Adet		Birim Fiyat TL / Adet
		Ø	Ø 1	A	B	C	D		Paket	Koli	
1523	GCL 1/4	7.4	6.6	10.3	9.1	1.27	M5	Beyaz	100	30.000	0.65
1524	GCL 3/8	10.9	9.7	11.9	9.2	1.27	M5	Beyaz	100	20.000	0.78

KARTUŞ YÜKSELTİCİ

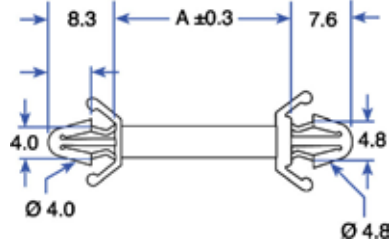
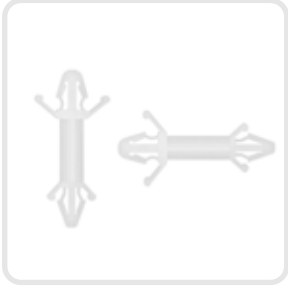

Malzeme : Saf Naylon 6.6 Standart UL
Çalışma Sıcaklığı : - 40 ° C --- +85 ° C

Sipariş Kodu	Ürün Kodu	Boyutlar		Renk	Ambalaj Adet		Birim Fiyat TL / Adet
		A			Paket	Koli	
1519	CBS - 9A	9.2		Beyaz	1.000	40.000	0.78
1520	CBS - 13A	12.6		Beyaz	1.000	30.000	0.80

BETON KROŞE

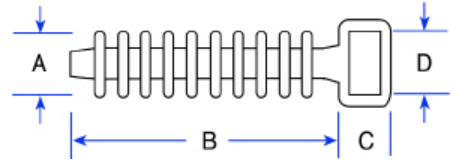

Sipariş Kodu	Ürün Kodu	Boyutlar				Maksimum Sıkma Çapı (mm)	Renk	Ambalaj Adet		Birim Fiyat TL / Adet
		A	B	C	D			Paket	Koli	
1525	TH - 2	9.5	36.0	6.0	9.5	9.5	Siyah	100	8.000	1.16

VİDALI KROŞE

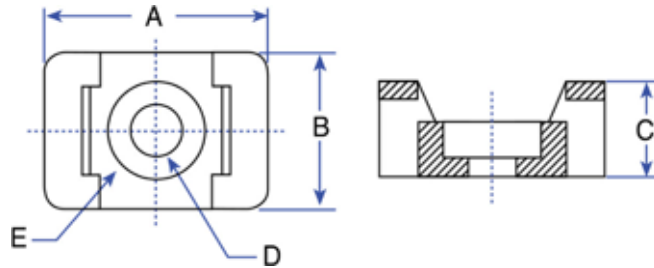

Sipariş Kodu	Ürün Kodu	Boyutlar					Maksimum Sıkma Çapı (mm)	Renk	Ambalaj Adet		Birim Fiyat TL / Adet
		A	B	C	D	E			Paket	Koli	
1511	VK V - 1	14.9	9.5	6.9	4.5	7.8	4.8	Beyaz	100	5.000	0.66
1512	VK V - 2	22.2	15.9	9.7	6.4	12.6	7.6	Beyaz	100	5.000	0.95

KABLO BAĞI ETİKET TAŞIYICI

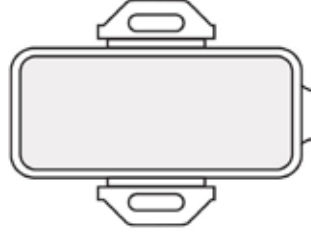

Malzeme : Polipropilen

Çalışma Sıcaklığı : 0 ° C --- +90 ° C

Sipariş Kodu	Ürün Kodu	Boyutlar			Etiket Eni (mm)	Etiket Boyu (mm)	Renk	Ambalaj Adet		Birim Fiyat TL / Adet
		A	B	C				Paket	Koli	
1526	GET - 1	35	10	8	32	7	Beyaz	100	8.000	1.60
1527	GET - 2	45	20	8	42	17	Beyaz	100	4.000	2.80

YAPIŞKANLI PANO ETİKET TAŞIYICI



Malzeme : ABS Altılık, PS Kapak + Çift Taraflı Bant

Çalışma Sıcaklığı : -40 ° C --- +60 ° C

Sipariş Kodu	Ürün Kodu	Boyutlar		Etiket Eni (mm)	Etiket Boyu (mm)	Renk	Ambalaj Adet		Birim Fiyat TL / Adet
		A	B				Paket	Koli	
1528	GPET - 1	30	17	27.5	14.4	Siyah	100	8.000	1.90
1529	GPET - 2	50	17	49	15	Siyah	50	5.000	2.50
1530	GPET - 3	75	17	72	15	Siyah	25	3.000	3.40

HELEZON SPİRALLER

Sipariş Kodu	Ürün Kodu	O.D.	T	W	Kablo Kesit (mm ²)	Renk	Paket Miktarı (Mt.)	Koli Miktarı (Mt.)	Birim Fiyat TL / Mt.
3251	GHS6 (No1)	6	0.60	7.4	2.5 - 15	Beyaz	10	1.000	5.30
3252	GHS8 (No2)	8	0.75	12	6 - 30	Beyaz	10	800	7.00
3253	GHS10 (No3)	10	0.80	12.3	7.5 - 30	Beyaz	10	500	8.50
3254	GHS12 (No4)	12	0.85	15	9 - 32	Beyaz	10	400	11.00
3255	GHS15 (No5)	15	1.00	15.5	12 - 35	Beyaz	10	250	18.00

Malzeme : PE

Esnek yapısı sayesinde kabloların düzenlemesine yardımcı olur.
Güçlü yapısı sayesinde tekrar kullanım için uygundur.

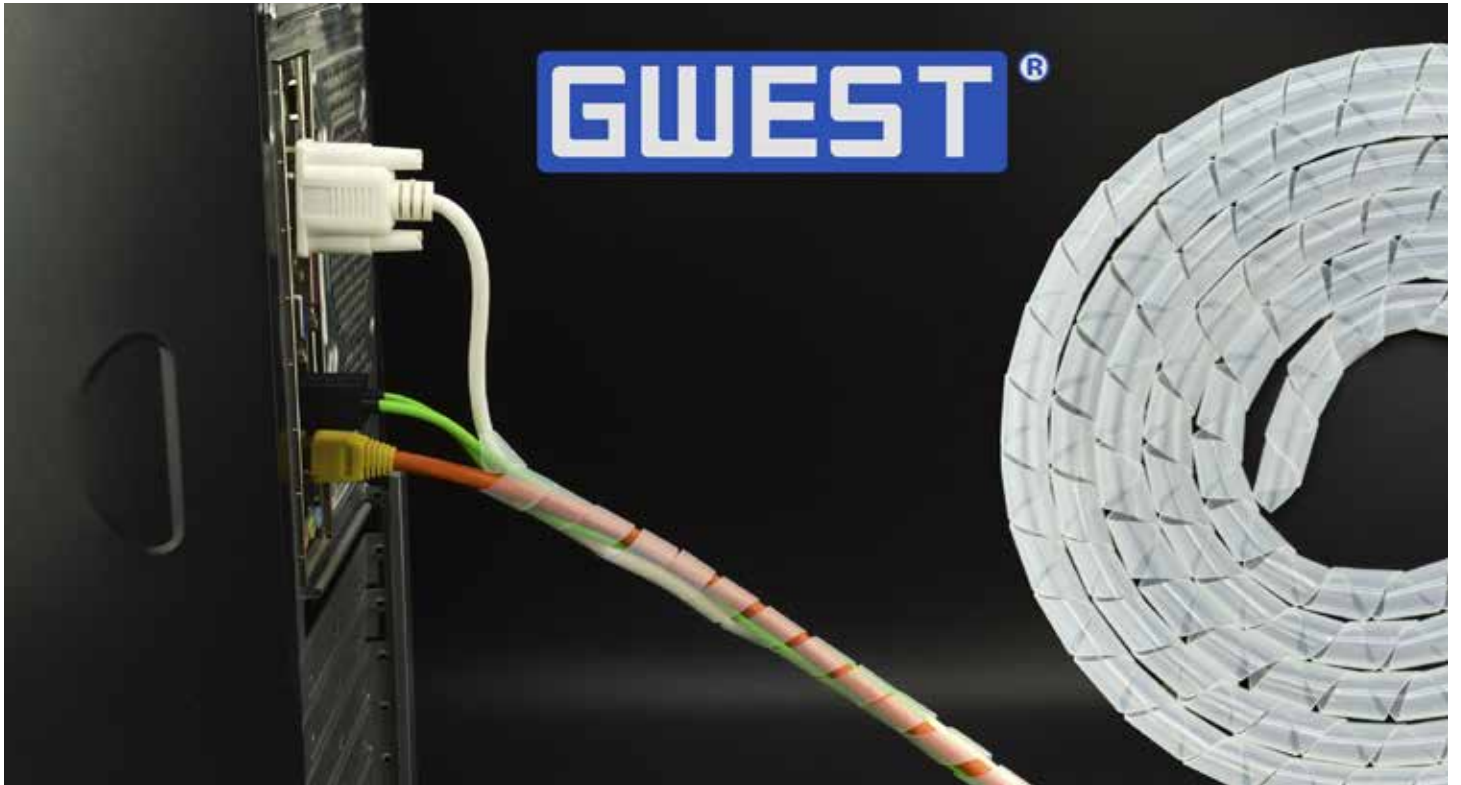
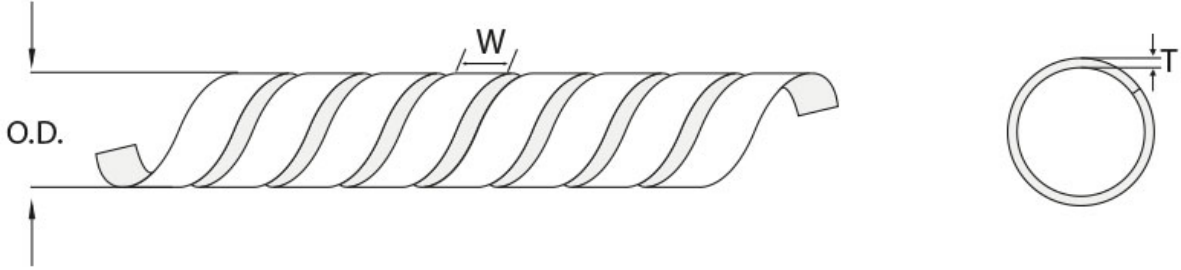



KABLO YÜKSÜKLERİ

Tek ve Çift Girişli



İZOLELİ KABLO YÜKSÜKLERİ FRANSIZ NORMU



Standart : DIN 46228
 Malzeme : Bakır, Kalay Kaplı
 İzolasyon : Naylon
 Çalışma Sıcaklığı : Maksimum 105° 600Volt Arası

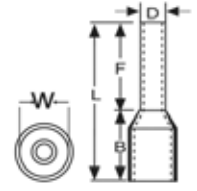

Sipariş Kodu	Ürün Kodu	Renk	Kablo Kesit (mm ²)	Ebatlar (mm)					Kutu Adet	Birim Fiyat TL / Adet
				F	L	W	B	D		
2001	IYF - 0.25	Menekşe	0.25 mm ²	8.0	12.0	1.9	4.4	1.1	1.000	0.530
2002	IYF - 0.34	Pembe	0.34 mm ²	8.0	12.0	1.9	4.4	1.1	1.000	0.530
2003	IYF - 0.50	Beyaz	0.50 mm ²	8.0	14.0	2.6	6.0	1.3	1.000	0.240
2004	IYF - 0.75	Mavi	0.75 mm ²	8.0	14.0	2.8	6.3	1.5	1.000	0.240
2005	IYF - 1.0	Kırmızı	1.00 mm ²	8.0	14.0	3.0	6.3	1.7	1.000	0.240
2006	IYF - 1.5	Siyah	1.50 mm ²	8.0	14.0	3.5	6.3	2.0	1.000	0.265
2007	IYF - 2.5	Gri	2.50 mm ²	8.0	14.0	4.2	7.4	2.5	500	0.345
2008	IYF - 4.0	Turuncu	4.00 mm ²	10.0	17.0	4.8	7.4	3.2	500	0.575
2009	IYF - 6.0	Yeşil	6.00 mm ²	12.0	20.0	6.3	8.5	3.9	250	0.775
2010	IYF - 10.0	Kahve	10.0 mm ²	12.0	22.0	7.6	8.8	4.9	100	0.985
2011	IYF - 16.0	Bej	16.0 mm ²	12.0	24.0	8.8	10.0	6.2	100	1.370
2012	IYF - 25.0	Siyah	25.0 mm ²	16.0	28.0	11.2	12.0	7.7	50	2.300
2013	IYF - 35.0	Kırmızı	35.0 mm ²	16.0	30.0	12.7	14.0	8.7	50	2.850
2014	IYF - 50.0	Mavi	50.0 mm ²	20.0	36.0	15.0	16.0	10.9	25	5.400
2015	İYF - 70.0	Sarı	70.0 mm ²	21.0	37.0	16.0	17.0	14.3	25	10.00



İZOLELİ KABLO YÜKSÜKLERİ ALMAN NORMU



Standart : DIN 46228
 Malzeme : Bakır, Kalay Kaplı
 İzolasyon : Naylon
 Çalışma Sıcaklığı : Maksimum 105° 600Volt Arası

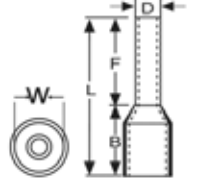

Sipariş Kodu	Ürün Kodu	Renk	Kablo Kesit (mm ²)	Ebatlar (mm)					Kutu Adet	Birim Fiyat TL / Adet
				F	L	W	B	D		
2101	IYA - 0.14	Gri	0.14 mm ²	8.0	12.0	1.6	2.8	0.9	1.000	0.530
2102	IYA - 0.25	Mavi	0.25 mm ²	8.0	12.0	1.9	4.4	1.1	1.000	0.530
2103	IYA - 0.34	Turkuaz	0.34 mm ²	8.0	12.0	1.9	4.4	1.1	1.000	0.530
2104	IYA - 0.50	Turuncu	0.50 mm ²	8.0	14.0	2.6	6.0	1.3	1.000	0.240
2105	IYA - 0.75	Beyaz	0.75 mm ²	8.0	14.0	2.8	6.3	1.5	1.000	0.240
2106	IYA - 1.0	Sarı	1.00 mm ²	8.0	14.0	3.0	6.3	1.7	1.000	0.240
2107	IYA - 1.5	Kırmızı	1.50 mm ²	8.0	14.0	3.5	6.3	2.0	1.000	0.265
2108	IYA - 2.5	Mavi	2.50 mm ²	8.0	14.0	4.2	7.4	2.5	500	0.345
2109	IYA - 4.0	Gri	4.00 mm ²	10.0	17.0	4.8	7.4	3.2	500	0.575
2110	IYA - 6.0	Siyah	6.00 mm ²	12.0	20.0	6.3	8.5	3.9	250	0.775
2111	IYA - 10.0	Bej	10.0 mm ²	12.0	22.0	7.6	8.8	4.9	100	0.985
2112	IYA - 16.0	Yeşil	16.0 mm ²	12.0	24.0	8.8	10.0	6.2	100	1.370
2113	IYA - 25.0	Kahve	25.0 mm ²	16.0	28.0	11.2	12.0	7.7	50	2.300
2114	IYA - 35.0	Bej	35.0 mm ²	16.0	30.0	12.7	14.0	8.7	50	2.850
2115	IYA - 50.0	Yeşil	50.0 mm ²	20.0	36.0	15.0	16.0	10.9	25	5.400



ÇİFT GİRİŞLİ KABLO YÜKSÜKLERİ FRANSIZ NORMU



Standart : DIN 46228
 Malzeme : Bakır, Kalay Kaplı
 İzolasyon : Naylon
 Çalışma Sıcaklığı : Maksimum 105° 600Volt Arası

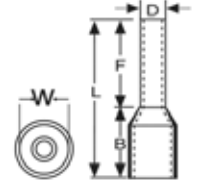

Sipariş Kodu	Ürün Kodu	Renk	Kablo Kesit (mm ²)	Ebatlar (mm)					Kutu Adet	Birim Fiyat TL / Adet
				F	L	W	B	D		
2201	CYF - 0.50	Beyaz	0.50 mm ²	8.0	14.0	5.0	6.5	1.8	1.000	0.430
2202	CYF - 0.75	Mavi	0.75 mm ²	8.0	14.0	5.5	6.7	2.1	500	0.460
2203	CYF - 1.0	Kırmızı	1.00 mm ²	8.0	14.0	5.5	7.1	2.4	500	0.490
2204	CYF - 1.5	Siyah	1.50 mm ²	8.0	14.0	6.4	7.5	2.6	500	0.590
2205	CYF - 2.5	Gri	2.50 mm ²	10.0	14.0	8.0	8.5	3.3	250	0.950
2206	CYF - 4.0	Turuncu	4.00 mm ²	12.0	17.0	8.0	11.1	4.2	200	1.100
2207	CYF - 6.0	Yeşil	6.00 mm ²	14.0	20.0	9.5	12.1	5.3	100	1.370
2208	CYF - 10.0	Kahve	10.0 mm ²	14.0	27.0	12.6	12.6	6.9	50	2.100
2209	CYF - 16.0	Bej	16.0 mm ²	14.0	31.0	19.0	17.3	8.7	50	2.650



ÇİFT GİRİŞLİ KABLO YÜKSÜKLERİ ALMAN NORMU



Standart : DIN 46228
 Malzeme : Bakır, Kalay Kaplı
 İzolasyon : Naylon
 Çalışma Sıcaklığı : Maksimum 105° 600Volt Arası

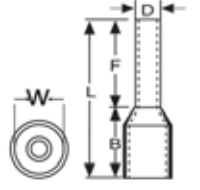

Sipariş Kodu	Ürün Kodu	Renk	Kablo Kesit (mm ²)	Ebatlar (mm)					Kutu Adet	Birim Fiyat TL / Adet
				F	L	W	B	D		
2301	CYA - 0.50	Turuncu	0.50 mm ²	8.0	14.0	5.0	6.5	1.8	1.000	0.430
2302	CYA - 0.75	Beyaz	0.75 mm ²	8.0	14.0	5.5	6.7	2.1	500	0.460
2303	CYA - 1.0	Sarı	1.00 mm ²	8.0	14.0	5.5	7.1	2.4	500	0.490
2304	CYA - 1.5	Kırmızı	1.50 mm ²	8.0	14.0	6.4	7.5	2.6	500	0.590
2305	CYA - 2.5	Mavi	2.50 mm ²	10.0	14.0	8.0	8.5	3.3	250	0.950
2306	CYA - 4.0	Gri	4.00 mm ²	12.0	17.0	8.0	11.1	4.2	200	1.100
2307	CYA - 6.0	Siyah	6.00 mm ²	14.0	20.0	9.5	12.1	5.3	100	1.370
2308	CYA - 10.0	Bej	10.0 mm ²	14.0	27.0	12.6	12.6	6.9	50	2.100
2309	CYA - 16.0	Yeşil	16.0 mm ²	14.0	31.0	19.0	17.3	8.7	50	2.650



İZOLESİZ KABLO YÜKSÜKLERİ



Standart : DIN 46228
 Malzeme : Bakır, Kalay Kaplı
 İzolasyon : Yok

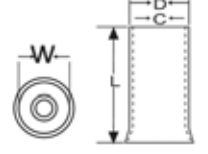

Sipariş Kodu	Ürün Kodu	Kablo Kesit (mm ²)	Ebatlar (mm)				Kutu Adet	Birim Fiyat TL / Adet
			L	W	D	C		
2401	KY - 0.50	0.50 mm ²	10	2.1	1.3	1.0	2.000	0.245
2402	KY - 0.75	0.75 mm ²	10	2.3	1.5	1.2	1.000	0.245
2403	KY - 1.0	1.00 mm ²	10	2.5	1.7	1.4	1.000	0.245
2404	KY - 1.5	1.50 mm ²	10	2.8	2.0	1.7	1.000	0.270
2405	KY - 2.5	2.50 mm ²	12	3.4	2.5	2.2	1.000	0.375
2406	KY - 4.0	4.00 mm ²	12	4.0	3.2	2.8	1.000	0.505
2407	KY - 6.0	6.00 mm ²	12	4.7	3.9	3.5	500	0.690
2408	KY - 10.0	10.0 mm ²	15	5.8	4.9	4.5	250	1.150
2409	KY - 16.0	16.0 mm ²	15	7.5	6.2	5.8	250	1.450
2410	KY - 25.0	25.0 mm ²	16	9.1	7.9	7.5	100	2.200
2411	KY - 35.0	35.0 mm ²	16	10.2	8.7	8.3	100	2.500
2412	KY - 50.0	50.0 mm ²	22	12.7	10.9	10.3	50	5.200





KABLO UÇLARI

Ve Terminaller



YUVARLAK TİP İZOLELİ KABLO UÇLARI



Standart : DIN 46237
 Malzeme : Bakır, Kalay Kaplı
 İzolasyon : PVC
 Çalışma Sıcaklığı : Maksimum 105° 600Volt Arası

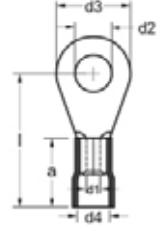

Sipariş Kodu	Ürün Kodu	Renk	Kablo Kesit (mm ²)	Civata Ölçüsü	Ebatlar (mm)						Kutu Adet	Birim Fiyat TL / Adet
					d2	d3	i	d1	d4	a		
3001	GYU - 301	■ Kırmızı	0.50 - 1.50 mm ²	M3	3.2	6.0	16.0	1.6	4.0	10.0	200	0.790
3003	GYU - 401	■ Kırmızı		M4	4.3	8.0	17.0	1.6	4.0	10.0	200	1.180
3004	GYU - 501	■ Kırmızı		M5	5.3	10.0	18.0	1.6	4.0	10.0	200	1.190
3005	GYU - 601	■ Kırmızı		M6	6.5	10.0	18.0	1.6	4.0	10.0	200	1.900
3006	GYU - 801	■ Kırmızı		M8	8.4	14.0	22.0	1.6	4.0	10.0	200	1.900
3007	GYU - 302	■ Mavi		1.50 - 2.50 mm ²	M3	3.2	6.0	16.0	2.3	4.5	10.0	200
3008	GYU - 402	■ Mavi	M4		4.3	8.0	17.0	2.3	4.5	10.0	200	1.450
3009	GYU - 502	■ Mavi	M5		5.3	10.0	19.0	2.3	4.5	10.0	200	1.470
3010	GYU - 602	■ Mavi	M6		6.5	11.0	20.0	2.3	4.5	10.0	200	2.100
3011	GYU - 802	■ Mavi	M8		8.4	14.0	22.0	2.3	4.5	10.0	200	2.100
3012	GYU - 1002	■ Mavi	M10		10.5	15.0	22.0	2.3	4.5	10.0	200	2.150
3013	GYU - 406	■ Sarı	4.00 - 6.00 mm ²	M4	4.3	8.6	21.0	3.6	6.3	13.0	100	3.100
3014	GYU - 506	■ Sarı		M5	5.3	10.0	22.0	3.6	6.3	13.0	100	3.100
3015	GYU - 606	■ Sarı		M6	6.5	11.0	22.5	3.6	6.3	13.0	100	3.500
3016	GYU - 806	■ Sarı		M8	8.4	14.0	26.0	3.6	6.3	13.0	100	4.500
3017	GYU - 1006	■ Sarı		M10	10.5	18.0	28.0	3.6	6.3	13.0	100	4.550
3018	GYU - 1206	■ Sarı		M12	13.0	18.0	28.0	3.6	6.3	13.0	100	4.650
3019	GYU - 610	■ Kırmızı	8.00 - 10.00 mm ²	M6	6.7	23.5	30.0	4.5	8.0	17.0	50	5.000
3020	GYU - 810	■ Kırmızı		M8	8.4	26.3	36.0	4.5	8.0	17.0	50	6.200

ÇATAL TİP İZOLELİ KABLO UÇLARI



Standart : DIN 46237
 Malzeme : Bakır, Kalay Kaplı
 İzolasyon : PVC
 Çalışma Sıcaklığı : Maksimum 105° 600Volt Arası

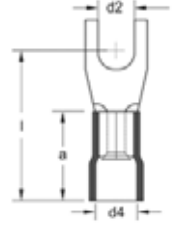

Sipariş Kodu	Ürün Kodu	Renk	Kablo Kesit (mm ²)	Civata Ölçüsü	Ebatlar (mm)						Kutu Adet	Birim Fiyat TL / Adet
					d2	d3	i	d1	d4	a		
3101	GÇU - 3001	Kırmızı	0.50 - 1.50 mm ²	M3	3.2	6.0	16.0	1.6	4.0	10.0	200	1.070
3102	GÇU - 4001	Kırmızı		M4	4.3	8.0	17.0	1.6	4.0	10.0	200	1.100
3103	GÇU - 5001	Kırmızı		M5	5.3	10.0	18.0	1.6	4.0	10.0	200	1.150
3104	GÇU - 6001	Kırmızı		M6	6.5	11.0	20.0	1.6	4.0	10.0	200	1.300
3105	GÇU - 3002	Mavi	1.50 - 2.50 mm ²	M3	3.2	5.5	18.0	2.3	4.5	10.0	200	1.200
3106	GÇU - 4002	Mavi		M4	4.3	6.8	17.0	2.3	4.5	10.0	200	1.230
3107	GÇU - 5002	Mavi		M5	5.3	10.0	19.0	2.3	4.5	10.0	200	1.250
3108	GÇU - 6002	Mavi		M6	6.5	11.0	21.0	2.3	4.5	10.0	200	1.650
3109	GÇU - 4006	Sarı	4.00 - 6.00 mm ²	M4	4.3	8.0	21.0	3.6	6.3	13.0	100	2.700
3110	GÇU - 5006	Sarı		M5	5.3	10.0	22.0	3.6	6.3	13.0	100	2.750
3111	GÇU - 6006	Sarı		M6	6.5	11.0	23.0	3.6	6.3	13.0	100	3.650
3112	GÇU - 8006	Sarı		M8	8.4	14.0	26.0	3.6	6.3	13.0	100	4.300

EK MUFLARI İZOLELİ KABLO UÇLARI



Standart : DIN 46237
 Malzeme : Bakır, Kalay Kaplı
 İzolasyon : PVC
 Çalışma Sıcaklığı : Maksimum 75° 600Volt Arası

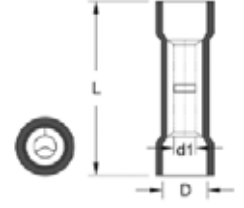

Sipariş Kodu	Ürün Kodu	Renk	Kablo Kesit (mm ²)	Ebatlar (mm)			Kutu Adet	Birim Fiyat TL / Adet
				L	D	d1		
3201	GBY - 251	Kırmızı	0.50 - 1.50 mm ²	24.6	4.0	1.7	200	1.650
3202	GBY - 252	Mavi	1.50 - 2.50 mm ²	24.6	4.5	2.3	200	1.670
3203	GBY - 256	Sarı	4.00 - 6.00 mm ²	26.5	6.3	3.4	100	2.800

ERKEK TERMİNALLER İZOLELİ KABLO UÇLARI



Malzeme : Pirinç, Kalay Kaplı, Bakır Yüksüklü
 İzolasyon : PVC
 Çalışma Sıcaklığı : Maksimum 75° 600Volt Arası

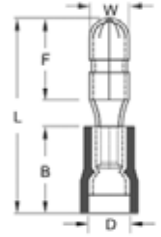

Sipariş Kodu	Ürün Kodu	Renk	Kablo Kesit (mm ²)	Ebatlar (mm)					Kutu Adet	Birim Fiyat TL / Adet
				W	F	L	B	D		
3204	GBE - 1040	Kırmızı	0.50 - 1.50 mm ²	4.0	8.5	21.5	10.5	3.8	200	2.800
3205	GBE - 2050	Mavi	1.50 - 2.50 mm ²	5.0	8.5	21.2	10.5	4.7	200	3.150
3206	GBE - 5050	Sarı	4.00 - 6.00 mm ²	5.0	8.5	24.0	13.0	6.2	200	4.250

DİŞİ TERMİNALLER İZOLELİ KABLO UÇLARI



Malzeme : Pirinç, Kalay Kaplı, Bakır Yüksüklü
 İzolasyon : PVC
 Çalışma Sıcaklığı : Maksimum 75° 600Volt Arası

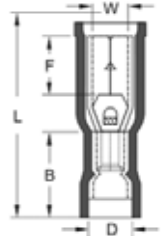

Sipariş Kodu	Ürün Kodu	Renk	Kablo Kesit (mm ²)	Ebatlar (mm)					Kutu Adet	Birim Fiyat TL / Adet
				W	F	L	B	D		
3207	GBD - 1040	Kırmızı	0.50 - 1.50 mm ²	3.9	7.0	23.3	10.5	3.8	200	3.350
3208	GBD - 2050	Mavi	1.50 - 2.50 mm ²	4.9	7.0	23.3	10.5	4.7	100	3.750
3209	GBD - 5050	Sarı	4.00 - 6.00 mm ²	4.9	7.0	25.1	12.5	6.2	100	4.700

DIŞI FASTON TİP İZOLELİ KABLO UÇLARI



Malzeme : Pirinç, Kalay Kaplı
İzolasyon : PVC
Çalışma Sıcaklığı : Maksimum 75° 600Volt Arası

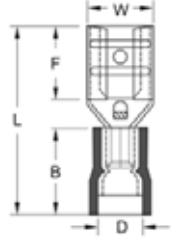

Sipariş Kodu	Ürün Kodu	Renk	Kablo Kesit (mm ²)	Soket Geniřlięi	Ebatlar (mm)					Kutu Adet	Birim Fiyat TL / Adet
					W	F	L	B	D		
3210	GFD - 1288	Kırmızı	0.50 - 1.50 mm ²	0.8 x 2.80	3.2	6.5	19.0	10.5	3.8	200	0.740
3211	GFD - 1488	Kırmızı		0.8 x 4.75	5.0	6.4	19.4	10.5	3.8	200	0.970
3212	GFD - 1638	Kırmızı		0.8 x 6.35	6.6	7.5	20.8	10.5	3.8	200	1.230
3213	GFD - 2288	Mavi	1.50 - 2.50 mm ²	0.8 x 2.80	3.2	6.5	19.0	10.5	4.7	200	0.970
3214	GFD - 2488	Mavi		0.8 x 4.75	5.0	6.4	19.4	10.5	4.7	200	1.000
3215	GFD - 2638	Mavi		0.8 x 6.35	6.6	7.5	20.8	10.5	4.7	200	1.250
3216	GFD - 5638	Sarı	4.00 - 6.00 mm ²	0.8 x 6.35	6.6	7.5	23.3	13.0	6.2	200	1.430

TAM İZOLELİ DIŞI FASTON TİP KABLO UÇLARI



Malzeme : Pirinç, Kalay Kaplı
İzolasyon : PVC
Çalışma Sıcaklığı : Maksimum 75° 600Volt Arası

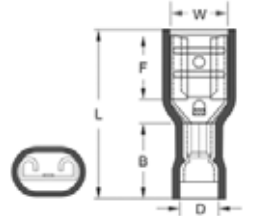

Sipariş Kodu	Ürün Kodu	Renk	Kablo Kesit (mm ²)	Soket Geniřlięi	Ebatlar (mm)					Kutu Adet	Birim Fiyat TL / Adet
					W	F	L	B	D		
3218	GFFD - 1288	Kırmızı	0.50 - 1.50 mm ²	0.8 x 2.80	3.2	6.5	19.0	10.5	3.8	200	1.200
3219	GFFD - 1488	Kırmızı		0.8 x 4.75	5.0	6.4	20.5	10.5	3.8	200	1.430
3220	GFFD - 1638	Kırmızı		0.8 x 6.35	6.6	7.5	21.8	10.5	3.8	200	1.680
3221	GFFD - 2288	Mavi	1.50 - 2.50 mm ²	0.8 x 2.80	3.2	6.5	20.0	10.5	4.7	200	1.430
3222	GFFD - 2488	Mavi		0.8 x 4.75	5.0	6.4	20.2	10.5	4.7	200	1.450
3223	GFFD - 2638	Mavi		0.8 x 6.35	6.6	7.5	22.2	10.5	4.7	200	1.750
3224	GFFD - 5638	Sarı	4.00 - 6.00 mm ²	0.8 x 6.35	6.6	7.5	24.2	12.5	6.2	100	2.000

TAM İZOLELİ POLYAMİD DİŞİ FASTON TİP KABLO UÇLARI



Malzeme : Piriç, Kalay Kaplı
İzolasyon : Polyamid
Çalışma Sıcaklığı : Maksimum 105° 600Volt Arası

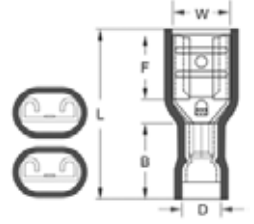

Sipariş Kodu	Ürün Kodu	Renk	Kablo Kesit (mm ²)	Soket Genişliği	Ebatlar (mm)					Kutu Adet	Birim Fiyat TL / Adet
					W	F	L	B	D		
3225	GPFD - 1638	■ Kırmızı	0.50 - 1.50 mm ²	0.8 x 6.35	6.6	7.5	21.5	11.0	4.0	200	4.250
3226	GPFD - 2638	■ Mavi	1.50 - 2.50 mm ²	0.8 x 6.35	6.6	7.5	21.5	11.0	5.0	200	4.250
3227	GPFD - 5638	■ Sarı	4.00 - 6.00 mm ²	0.8 x 6.35	6.6	7.5	24.2	13.0	6.5	100	5.100

İĞNE TİP İZOLELİ KABLO UÇLARI



Malzeme : Piriç, Kalay Kaplı
İzolasyon : PVC
Çalışma Sıcaklığı : Maksimum 75° 600Volt Arası

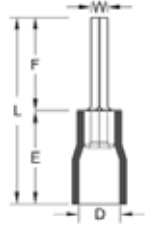

Sipariş Kodu	Ürün Kodu	Renk	Kablo Kesit (mm ²)	Ebatlar (mm)					Kutu Adet	Birim Fiyat TL / Adet
				W	F	L	E	D		
3228	GİK - 101	■ Kırmızı	0.50 - 1.50 mm ²	1.9	10.0	19.0	10.0	4.0	200	1.250
3229	GİK - 102	■ Mavi	1.50 - 2.50 mm ²	1.9	12.0	21.8	10.0	4.5	200	1.500
3230	GİK - 106	■ Sarı	4.00 - 6.00 mm ²	2.8	14.0	27.0	27.0	6.4	100	3.600

ERKEK / DİŞİ GERİ DÖNÜŞLÜ TERMİNALER



Malzeme : Piriç, Kalay Kaplı
İzolasyon : PVC
Çalışma Sıcaklığı : Maksimum 75° 600Volt Arası

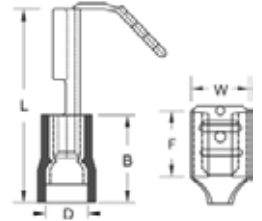

Sipariş Kodu	Ürün Kodu	Renk	Kablo Kesit (mm ²)	Soket Genişliği	Ebatlar (mm)					Kutu Adet	Birim Fiyat TL / Adet
					W	F	L	B	D		
3231	GFDEG - 1861	■ Kırmızı	0.50 - 1.50 mm ²	0.8 x 6.35	6.6	8.0	22.5	10.5	3.8	100	2.300
3232	GFDEG - 2862	■ Mavi	1.50 - 2.50 mm ²	0.8 x 6.35	6.6	8.0	22.5	10.5	4.7	100	2.400
3233	GFDEG - 5866	■ Sarı	4.00 - 6.00 mm ²	0.8 x 6.35	6.6	8.0	24.0	13.0	6.2	100	2.800

ERKEK FASTON TİP TERMİNALLER



Malzeme : Pirinç, Kalay Kaplı
İzolasyon : PVC
Çalışma Sıcaklığı : Maksimum 75° 600Volt Arası

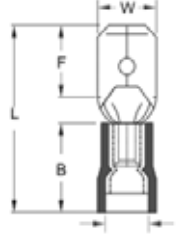

Sipariş Kodu	Ürün Kodu	Renk	Kablo Kesit (mm ²)	Soket Genişliği	Ebatlar (mm)					Kutu Adet	Birim Fiyat TL / Adet
					W	F	L	B	D		
3236	GFE - 1288	Kırmızı	0.50 - 1.50 mm ²	0.8 x 2.80	2.8	6.5	19.2	10.5	3.8	200	0.800
3237	GFE - 1488	Kırmızı		0.8 x 4.75	4.8	6.7	19.8	10.5	3.8	200	0.900
3238	GFE - 1638	Kırmızı		0.8 x 6.35	6.35	6.35	21.8	10.5	3.8	200	1.150
3239	GFE - 2288	Mavi	1.50 - 2.50 mm ²	0.8 x 2.80	2.8	6.7	19.8	10.5	4.7	200	0.800
3240	GFE - 2488	Mavi		0.8 x 4.75	4.8	6.7	19.8	10.5	4.7	200	1.000
3241	GFE - 2638	Mavi		0.8 x 6.35	6.35	7.7	21.8	10.5	4.7	200	1.200
3242	GFE - 5638	Sarı	4.00 - 6.00 mm ²	0.8 x 6.35	6.35	7.7	24.8	13.0	6.2	200	1.430

TAM İZOLELİ POLYAMİD BAYRAK TİP TERMİNALLER





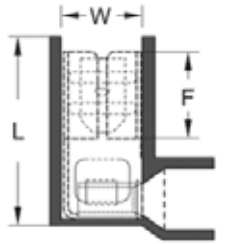





















Malzeme : Pirinç, Kalay Kaplı
İzolasyon : Polyamid
Çalışma Sıcaklığı : Maksimum 105° 600Volt Arası



Sipariş Kodu	Ürün Kodu	Renk	Kablo Kesit (mm ²)	Soket Genişliği	Ebatlar (mm)			Kutu Adet	Birim Fiyat TL / Adet
					W	F	L		
3234	GPFDEB - 1861	Kırmızı	0.50 - 1.50 mm ²	0.8 x 6.35	6.6	7.6	16.0	100	3.100
3235	GPFDEB - 2862	Mavi	1.50 - 2.50 mm ²	0.8 x 6.35	6.6	7.6	16.0	100	3.100

İZOLESİZ KABLO UCU VE KONNEKTÖRLERİ

					
Sipariş Kodu	3301	3302	3303	3305	3304
Ürün Kodu	GF1/2D	GF1D MİNİ	GF1D	GF3D	GF2D TRK
Açıklama	2.8 Mikro Dişi Terminal	4.8 Mini Dişi Terminal	6.3 Dişi Terminal	9.5 Dişi Terminal	6.3 Tırnaklı Dişi Terminal
Kutu Adet	1.000	500	300	100	300
Birim Fiyat TL / Adet	0.630	0.760	0.980	2.800	0.980
					
Sipariş Kodu	3306	3307	3320	3321	3309
Ürün Kodu	GF1D EĞRİ	GF1D E	GKN 1-03	GKN 1-04	GKN 2.5-04
Açıklama	6.3 Eğri Dişi Terminal	6.3 Erkek Geri Dönüşümlü Terminal	M3 Topraklama Terminali	M4 Topraklama Terminali	M4 Topraklama Terminali
Kutu Adet	250	200	500	500	500
Birim Fiyat TL / Adet	1.270	2.450	0.940	0.940	0.960
					
Sipariş Kodu	3310	3311	3312	3313	3314
Ürün Kodu	GKN 2.5-05	GKN 2.5-06	GKN 4-04	GKN 4-05	GKN 4-06
Açıklama	M5 Topraklama Terminali	M6 Topraklama Terminali	M4 Topraklama Terminali	M5 Topraklama Terminali	M6 Topraklama Terminali
Kutu Adet	500	500	250	250	250
Birim Fiyat TL / Adet	0.960	0.960	1.800	1.800	1.800
					
Sipariş Kodu	3315	3316	3318	3325	3326
Ürün Kodu	GKN 6-06	GKN 8-08	GKN 10-10	GK 2.5	GK 4
Açıklama	M6 Topraklama Terminali	M8 Topraklama Terminali	M10 Topraklama Terminali	Boru Tip Topraklama Terminali	Boru Tip Topraklama Terminali
Kutu Adet	150	150	100	1.000	500
Birim Fiyat TL / Adet	2.800	2.800	3.150	0.900	1.500
					
Sipariş Kodu	3327	3332	3333	3341	3340
Ürün Kodu	GK 6	GF1E ÇK	GF1EU1	R TİPİ KONNEKTÖR	GF1D KILIF
Açıklama	Boru Tip Topraklama Terminali	6.3 Erkek Terminal	6.3 Uzun Erkek Terminal	6.3 Kilitli Konnektör	6.3 Terminal Kılıfı
Kutu Adet	250	300	300	300	300
Birim Fiyat TL / Adet	2.200	1.000	1.250	0.750	0.530



İMALATLARIMIZ Ve Bağlantı Elemanları

Sıkmalı Kablo Pabucu
DIN Kablo Pabucu
Bimetal Kablo Pabucu
Montaj Rayları
W Otomat Baraları
U Klemenesler



www.guvenelektrik.com.tr

SKP EKO TİP KABLO PABUCU

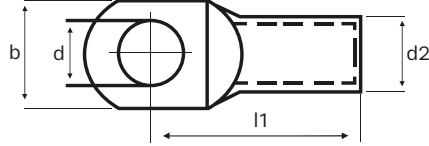
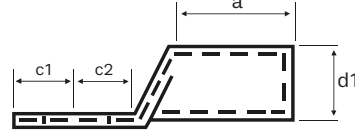

Gwest Eko Tip Kablo Pabuçlarımız;

- * **EN/13600** standartlarında bakır malzemeden imal edilmiştir.
- * Sıkma işlemi yapılırken kırılmayı, sıkma işlemi sonrasında gevşemeyi önlemek için üretim esnasında **tavlı bakır borular** kullanılmıştır.
- * Üretimde **%99.9** oranında iletkenliğe sahip bakır kullanılmıştır.
- * **5-8 Micron** aralığında **100% Kalay** kaplama yapılmaktadır.

Sipariş Kodu	Ürün Kodu	Kablo Kesit (mm ²)	Delik Çapı Ø	Boyutlar								Kutu Adet	Birim Fiyat TL / Adet
				d	d1	d2	l1	a	b	c1	c2		
3400	SKP-E 16-6	16 mm ²	M6	6,4	5,5	7,0	24,5	11,0	10,5	5,5	6,5	500	7.30
3401	SKP-E 16-8		M8	8,3	5,5	7,0	24,5	11,0	10,5	5,5	6,5	500	7.30
3402	SKP-E 25-6	25 mm ²	M6	6,5	7,0	9,0	31,7	12,0	13,0	6,8	9,2	400	15.00
3403	SKP-E 25-8		M8	8,3	7,0	9,0	31,7	12,0	13,0	6,8	9,2	400	15.00
3404	SKP-E 35-6	35 mm ²	M6	6,5	8,5	10,5	35,2	14,0	15,5	8,3	9,7	300	20.00
3405	SKP-E 35-8		M8	8,3	8,5	10,5	35,2	14,0	15,5	8,3	9,7	300	20.00
3406	SKP-E 50-8	50 mm ²	M8	8,2	10,0	12,0	41,5	17,0	17,9	10,0	12,0	200	28.00
3407	SKP-E 50-10		M10	10,3	10,0	12,0	41,5	17,0	17,9	10,0	12,0	200	28.00
3408	SKP-E 70-10	70 mm ²	M10	10,3	11,5	14,0	45,5	18,0	20,7	10,0	12,0	100	43.00
3409	SKP-E 70-12		M12	13,0	11,5	14,0	45,5	18,0	20,7	10,0	12,0	100	43.00

SKP EKO TİP KABLO PABUCU

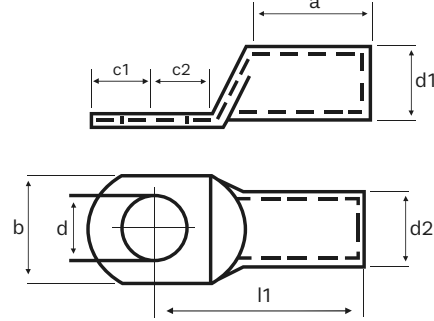

Gwest Eko Tip Kablo Pabuçlarımız;

- * EN/13600 standartlarında bakır malzemeden imal edilmiştir.
- * Sıkma işlemi yapılırken kırılmayı, sıkma işlemi sonrasında gevşemeyi önlemek için üretim esnasında **tavlı bakır borular** kullanılmıştır.
- * Üretimde **%99.9** oranında iletkenliğe sahip bakır kullanılmıştır.
- * **5-8 Micron** aralığında **100% Kalay** kaplama yapılmaktadır.

Sipariş Kodu	Ürün Kodu	Kablo Kesit (mm ²)	Delik Çapı Ø	Boyutlar								Kutu Adet	Birim Fiyat TL / Adet
				d	d1	d2	l1	a	b	c1	c2		
3410	SKP-E 95-10	95 mm ²	M10	10,3	13,5	16,0	48,5	21,0	23,5	10,0	12,0	75	53.00
3411	SKP-E 95-12		M12	12,8	13,5	16,0	48,5	21,0	23,5	10,0	12,0	75	53.00
3412	SKP-E 120-10	120 mm ²	M10	10,5	15,5	18,0	58,0	25,0	26,7	13,0	14,5	50	70.00
3413	SKP-E 120-12		M12	12,8	15,5	18,0	58,0	25,0	26,7	13,0	14,5	50	70.00
3414	SKP-E 150-10	150 mm ²	M10	10,5	16,5	20,0	59,5	26,0	29,2	16,5	16,5	40	120.00
3415	SKP-E 150-12		M12	12,8	16,5	20,0	59,5	26,0	29,2	16,5	16,5	40	120.00
3416	SKP-E 185-12	185 mm ²	M12	10,5	18,5	22,0	65,0	29,0	32,3	17,0	18,0	30	140.00
3417	SKP-E 185-16		M16	16,5	18,5	22,0	65,0	29,0	32,3	17,0	18,0	30	140.00
3418	SKP-E 240-12	240 mm ²	M12	13,0	21,5	25,5	74,0	33,0	37,6	17,0	18,0	25	200.00
3419	SKP-E 240-16		M16	16,5	21,5	25,5	74,0	33,0	37,6	17,0	18,0	25	200.00

SKP STANDART TİP KABLO PABUCU

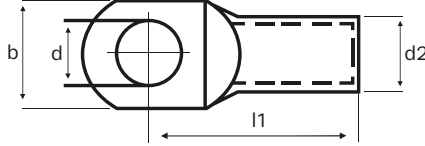
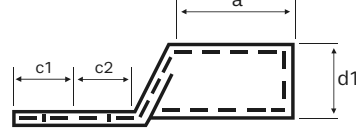

Gwest Eko Tip Kablo Pabuçlarımız;

- * **EN/13600** standartlarında bakır malzemeden imal edilmiştir.
- * Sıkma işlemi yapılırken kırılmayı, sıkma işlemi sonrasında gevşemeyi önlemek için üretim esnasında **tavlı bakır borular** kullanılmıştır.
- * Üretimde **%99.9** oranında iletkenliğe sahip bakır kullanılmıştır.
- * **5-8 Micron** aralığında **100% Kalay** kaplama yapılmaktadır.

Sipariş Kodu	Ürün Kodu	Kablo Kesit (mm ²)	Delik Çapı Ø	Boyutlar								Kutu Adet	Birim Fiyat TL / Adet
				d	d1	d2	l1	a	b	c1	c2		
3430	SKP-S 10-5	10 mm ²	M5	5,5	4,7	6,6	22,0	10,0	10,3	5,5	7,0	1.000	7.30
3431	SKP-S 10-6		M6	6,5	4,7	6,6	22,0	10,0	10,3	5,5	7,0	1.000	7.30
3432	SKP-S 10-8		M8	8,5	4,7	6,6	23,7	10,0	13,5	6,8	8,7	1.000	7.30
3390	SKP-S 16-5	16 mm ²	M5	5,5	5,6	7,8	24,0	12,0	11,2	5,5	6,5	500	11.00
3433	SKP-S 16-6		M6	6,5	5,6	7,8	24,0	12,0	11,2	5,5	6,5	500	11.00
3434	SKP-S 16-8		M8	8,5	5,6	7,8	26,2	12,0	13,5	6,8	8,7	500	12.50
3435	SKP-S 16-10	M10	10,5	5,6	7,8	26,0	12,0	16,0	7,5	8,5	500	12.50	
3436	SKP-S 25-6	25 mm ²	M6	6,5	7,1	9,5	32,2	16,0	13,7	6,8	9,2	400	19.50
3437	SKP-S 25-8		M8	8,5	7,1	9,5	32,2	16,0	13,7	6,8	9,2	400	19.50
3438	SKP-S 25-10		M10	10,5	7,1	9,5	34,0	16,0	16,0	8,0	11,0	300	19.50
3439	SKP-S 35-6	35 mm ²	M6	6,5	8,2	10,8	35,7	19,0	15,3	8,3	9,7	200	27.00
3440	SKP-S 35-8		M8	8,5	8,2	10,8	35,7	19,0	15,3	8,3	9,7	200	27.00
3441	SKP-S 35-10		M10	10,5	8,2	10,8	38,0	19,0	15,7	10,0	12,0	200	29.00
3391	SKP-S 35-12		M12	13,0	8,2	10,8	38,0	19,0	18,0	10,0	12,0	150	29.00
3389	SKP-S 50-6	50 mm ²	M6	6,5	10,1	13,0	39,2	21,0	18,9	8,3	9,7	150	39.00
3442	SKP-S 50-8		M8	8,5	10,1	13,0	39,2	21,0	18,9	8,3	9,7	150	39.00
3443	SKP-S 50-10		M10	10,5	10,1	13,0	41,5	21,0	18,9	10,0	12,0	150	42.00
3444	SKP-S 50-12		M12	13,0	10,1	13,0	41,5	21,0	18,9	10,0	12,0	150	42.00
3446	SKP-S 70-8	70 mm ²	M8	8,5	11,5	14,7	42,3	23,0	21,1	8,3	9,7	100	55.00
3447	SKP-S 70-10		M10	10,5	11,5	14,7	44,6	23,0	21,1	10,0	12,0	100	55.00
3448	SKP-S 70-12		M12	13,0	11,5	14,7	44,6	23,0	21,1	10,0	12,0	100	55.00
3449	SKP-S 70-14		M14	15,0	11,5	14,7	47,6	23,0	21,5	15,0	15,0	100	62.00
3392	SKP-S 70-16		M16	17,0	11,5	14,7	47,6	23,0	21,5	15,0	15,0	100	62.00

SKP STANDART TİP KABLO PABUCU

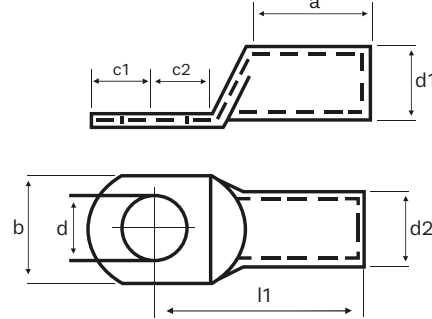

Gwest Eko Tip Kablo Pabuçlarımız;

- * EN/13600 standartlarında bakır malzemeden imal edilmiştir.
- * Sıkma işlemi yapılırken kırılmayı, sıkma işlemi sonrasında gevşemeyi önlemek için üretim esnasında **tavlı bakır borular** kullanılmıştır.
- * Üretimde **%99.9** oranında iletkenliğe sahip bakır kullanılmıştır.
- * **5-8 Micron** aralığında **100% Kalay** kaplama yapılmaktadır.

Sipariş Kodu	Ürün Kodu	Kablo Kesit (mm ²)	Delik Çapı Ø	Boyutlar								Kutu Adet	Birim Fiyat TL / Adet
				d	d1	d2	l1	a	b	c1	c2		
3450	SKP-S 95-8	95 mm ²	M8	8,5	13,5	16,7	48,8	26,0	24,7	10,0	12,0	75	70.00
3451	SKP-S 95-10		M10	10,5	13,5	16,7	48,8	26,0	24,7	10,0	12,0	75	70.00
3452	SKP-S 95-12		M12	13,0	13,5	16,7	48,8	26,0	24,7	10,0	12,0	75	70.00
3453	SKP-S 120-10	120 mm ²	M10	10,5	15,6	19,0	56,0	29,0	27,7	13,0	14,5	50	98.00
3454	SKP-S 120-12		M12	13,0	15,6	19,0	56,0	29,0	27,7	13,0	14,5	50	98.00
3393	SKP-S 120-14		M14	15,0	15,6	19,0	56,0	29,0	27,7	13,0	14,5	50	100.00
3455	SKP-S 120-16	150 mm ²	M16	17,0	15,6	19,0	56,0	29,0	27,7	13,0	14,5	50	100.00
3456	SKP-S 150-10		M10	10,5	16,5	21,0	60,0	30,0	30,4	16,5	16,5	40	155.00
3457	SKP-S 150-12		M12	13,0	16,5	21,0	60,0	30,0	30,4	16,5	16,5	40	155.00
3394	SKP-S 150-14	185 mm ²	M14	15,0	16,5	21,0	60,0	30,0	30,4	16,5	16,5	40	155.00
3458	SKP-S 150-16		M16	17,0	16,5	21,0	60,0	30,0	30,4	16,5	16,5	40	155.00
3395	SKP-S 185-10		M10	10,5	18,4	23,0	65,5	33,0	34,2	17,0	18,0	30	190.00
3459	SKP-S 185-12	240 mm ²	M12	13,0	18,4	23,0	65,5	33,0	34,2	17,0	18,0	30	190.00
3396	SKP-S 185-14		M14	15,0	18,4	23,0	65,5	33,0	34,2	17,0	18,0	30	190.00
3460	SKP-S 185-16		M16	17,0	18,4	23,0	65,5	33,0	34,2	17,0	18,0	30	190.00
3397	SKP-S 240-10	300 mm ²	M10	10,5	21,0	26,0	72,0	38,0	38,7	17,0	18,0	25	250.00
3461	SKP-S 240-12		M12	13,0	21,0	26,0	72,0	38,0	38,7	17,0	18,0	25	250.00
3398	SKP-S 240-14		M14	15,0	21,0	26,0	72,0	38,0	38,7	17,0	18,0	25	250.00
3462	SKP-S 240-16	M16	17,0	21,0	26,0	72,0	38,0	38,7	17,0	18,0	25	250.00	
3399	SKP-S 300-12		M12	13,0	23,4	28,6	77,0	41,0	42,6	18,0	18,0	20	300.00
3463	SKP-S 300-14		M14	15,0	23,4	28,6	77,0	41,0	42,6	18,0	18,0	20	300.00
3464	SKP-S 300-16		M16	17,0	23,4	28,6	77,0	41,0	42,6	18,0	18,0	20	300.00

DIN 46235 TİPİ KABLO PABUCU



- * EN/13600 standartlarında bakır malzemeden imal edilmiştir.
- * Sıkma işlemi yapılırken kırılmayı, sıkma işlemi sonrasında gevşemeyi önlemek için üretim esnasında tavlı bakır borular kullanılmıştır.
- * Üretimde %99.9 oranında iletkenliğe sahip bakır kullanılmıştır.
- * 5-8 Micron aralığında 100% Kalay kaplama yapılmaktadır.

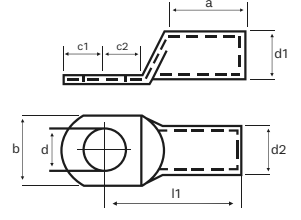

Sipariş Kodu	Ürün Kodu	Kablo Kesit (mm ²)	Delik Çapı Ø	Boyutlar (mm)								Kutu Adet	Birim Fiyat TL / Adet
				d	d1	d2	l1	a	b	c1	c2		
7000	SKP-D 10-5	10 mm ²	M5	5,3	4,5	7,0	27,0	10,0	9,0	7,0	8,5	500	11.00
7001	SKP-D 10-6		M6	6,4	4,5	7,0	27,0	10,0	9,0	7,5	8,5	500	11.00
7002	SKP-D 16-6	16 mm ²	M6	6,4	5,5	8,5	36,0	20,0	13,0	7,5	8,0	250	24.00
7003	SKP-D 16-8		M8	8,4	5,5	8,5	36,0	20,0	13,0	10,0	10,0	250	24.00
7004	SKP-D 16-10		M10	10,5	5,5	8,5	36,0	20,0	17,0	12,0	12,0	250	24.00
7005	SKP-D 25-6	25 mm ²	M6	6,4	7,0	10,0	38,0	20,0	14,0	7,5	8,0	200	32.00
7006	SKP-D 25-8		M8	8,4	7,0	10,0	38,0	20,0	16,0	10,0	10,0	200	32.00
7007	SKP-D 25-10		M10	10,5	7,0	10,0	38,0	20,0	17,0	12,0	12,0	200	32.00
7008	SKP-D 25-12		M12	13,0	7,0	10,0	38,0	20,0	19,0	13,0	13,0	200	32.00
7009	SKP-D 35-8	35 mm ²	M8	8,4	8,2	12,5	42,0	20,0	17,0	10,0	10,0	120	56.00
7010	SKP-D 35-10		M10	10,5	8,2	12,5	42,0	20,0	19,0	12,0	12,0	120	56.00
7011	SKP-D 35-12		M12	13,0	8,2	12,5	42,0	20,0	21,0	13,0	13,0	120	56.00
7012	SKP-D 50-8	50 mm ²	M8	8,4	10,0	14,5	52,0	28,0	20,0	10,0	10,0	65	85.00
7013	SKP-D 50-10		M10	10,5	10,0	14,5	52,0	28,0	22,0	12,0	12,0	65	85.00
7014	SKP-D 50-12		M12	13,0	10,0	14,5	52,0	28,0	24,0	13,0	13,0	65	85.00
7015	SKP-D 50-16		M16	17,0	10,0	14,5	52,0	28,0	28,0	16,0	16,0	65	85.00
7016	SKP-D 70-8	70 mm ²	M8	8,4	11,5	16,5	55,0	28,0	24,0	10,0	10,0	50	120.00
7017	SKP-D 70-10		M10	10,5	11,5	16,5	55,0	28,0	24,0	12,0	12,0	50	120.00
7018	SKP-D 70-12		M12	13,0	11,5	16,5	55,0	28,0	24,0	13,0	13,0	50	120.00
7019	SKP-D 70-16		M16	17,0	11,5	16,5	55,0	28,0	30,0	16,0	16,0	50	120.00

DIN 46235 TİPİ KABLO PABUCU



- * EN/13600 standartlarında bakır malzemeden imal edilmiştir.
- * Sıkma işlemi yapılırken kırılmayı, sıkma işlemi sonrasında gevşemeyi önlemek için üretim esnasında tavlı bakır borular kullanılmıştır.
- * Üretimde %99.9 oranında iletkenliğe sahip bakır kullanılmıştır.
- * 5-8 Micron aralığında 100% Kalay kaplama yapılmaktadır.

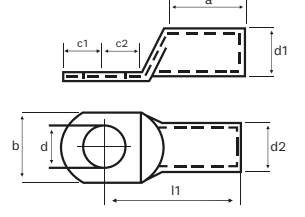

Sipariş Kodu	Ürün Kodu	Kablo Kesit (mm ²)	Delik Çapı Ø	Boyutlar (mm)								Kutu Adet	Birim Fiyat TL / Adet
				d	d1	d2	l1	a	b	c1	c2		
7020	SKP-D 95-10	95 mm ²	M10	10,5	13,5	19,0	65,0	35,0	28,0	12,0	12,0	30	162.00
7021	SKP-D 95-12		M12	13,0	13,5	19,0	65,0	35,0	28,0	13,0	13,0	30	162.00
7022	SKP-D 95-16		M16	17,0	13,5	19,0	65,0	35,0	32,0	16,0	16,0	30	162.00
7023	SKP-D 120-10	120 mm ²	M10	10,5	15,5	21,0	70,0	35,0	32,0	15,0	16,0	25	220.00
7024	SKP-D 120-12		M12	13,0	15,5	21,0	70,0	35,0	32,0	16,0	17,0	25	220.00
7025	SKP-D 120-16		M16	17,0	15,5	21,0	70,0	35,0	32,0	19,0	20,0	25	220.00
7026	SKP-D 120-20		M20	21,0	15,5	21,0	70,0	35,0	38,0	21,0	22,0	25	220.00
7027	SKP-D 150-10	150 mm ²	M10	10,5	17,0	23,5	78,0	35,0	34,0	15,0	16,0	20	300.00
7028	SKP-D 150-12		M12	13,0	17,0	23,5	78,0	35,0	34,0	16,0	17,0	20	300.00
7029	SKP-D 150-16		M16	17,0	17,0	23,5	78,0	35,0	34,0	19,0	20,0	20	300.00
7030	SKP-D 150-20		M20	21,0	17,0	23,5	78,0	35,0	40,0	21,0	22,0	20	300.00
7031	SKP-D 185-10	185 mm ²	M10	10,5	19,0	25,5	82,0	40,0	37,0	15,0	16,0	15	340.00
7032	SKP-D 185-12		M12	13,0	19,0	25,5	82,0	40,0	37,0	16,0	17,0	15	340.00
7033	SKP-D 185-16		M16	17,0	19,0	25,5	82,0	40,0	37,0	19,0	20,0	15	340.00
7034	SKP-D 185-20		M20	21,0	19,0	25,5	82,0	40,0	40,0	21,0	22,0	15	340.00
7035	SKP-D 240-12	240 mm ²	M12	13,0	21,5	29,0	92,0	40,0	42,0	16,0	17,0	10	480.00
7036	SKP-D 240-16		M16	17,0	21,5	29,0	92,0	40,0	42,0	19,0	20,0	10	480.00
7037	SKP-D 240-20		M20	21,0	21,5	29,0	92,0	40,0	45,0	21,0	22,0	10	480.00
7038	SKP-D 300-16	300 mm ²	M16	17,0	24,5	32,0	100,0	50,0	48,0	19,0	22,0	10	580.00
7039	SKP-D 300-20		M20	21,0	24,5	32,0	100,0	50,0	48,0	22,0	22,0	10	580.00

BİMETAL (AL-CU) KABLO PAPUCU



Teknik Özellikler

İletken Malzeme

Malzeme : %99.9 Alüminyum ve Bakır

Çekme Derecesi : 110MPa

Çalışma Sıcaklığı : - 40 ° C --- +100 ° C



Sipariş Kodu	Ürün Kodu	Kablo Kesit (mm ²)	Delik Çapı Ø	Boyutlar (mm)					Kutu Adet	Birim Fiyat TL / Adet
				d	D	l1	L	B		
7050	SKP-BM 16-10	16 mm ²	M10	5.5	16	43	85	21	80	82.00
7051	SKP-BM 25-10	25 mm ²	M10	6.5	16	43	85	21	80	82.00
7052	SKP-BM 35-10	35 mm ²	M10	8.0	16	43	85	21	80	82.00
7053	SKP-BM 50-12	50 mm ²	M12	9.0	20	43	90	25.6	50	105.00
7054	SKP-BM 70-12	70 mm ²	M12	11.0	20	43	90	25.6	50	105.00
7055	SKP-BM 95-12	95 mm ²	M12	12.5	20	43	90	25.6	50	105.00
7056	SKP-BM 120-12	120 mm ²	M12	13.7	25	59	115	30	30	185.00
7057	SKP-BM 150-12	150 mm ²	M12	15.5	25	59	115	30	30	185.00
7058	SKP-BM 185-12	185 mm ²	M12	17.0	32	60	122	35	15	325.00
7059	SKP-BM 240-12	240 mm ²	M12	19.5	32	60	122	35	15	325.00
7060	SKP-BM 300-12	300 mm ²	M12	23.5	34	65	127	35	15	375.00
7061	SKP-BM 400-16	400 mm ²	M16	26.0	40	90	160	36	9	550.00

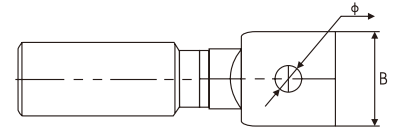
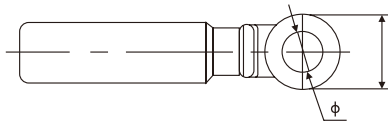
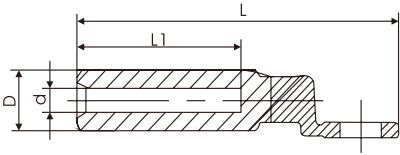

Açıklama

Bimetal kablo pabuçları, alüminyum iletkenlerle, dağıtım ekipmanlarındaki güç kabloları ve elektrik ekipmanlarının bakır terminallerine bağlantısında kullanılan kablo pabucu çeşididir. Kullanılan alüminyum ve bakır elektrolitik özellikli olup iletkenlik derecesi çok iyidir.



EK MUFLARI

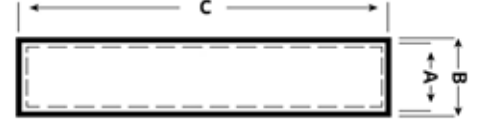

Gwest Ek Muflarımız;

- * **EN/13600** standartlarında bakır malzemeden imal edilmiştir.
- * Sıkma işlemi yapılırken kırılmayı, sıkma işlemi sonrasında gevşemeyi önlemek için üretim esnasında **tavlı bakır borular** kullanılmıştır.
- * Üretimde **%99.9** oranında iletkenliğe sahip bakır kullanılmıştır.
- * **5-8 Micron** aralığında **100% Kalay** kaplama yapılmaktadır.

Sipariş Kodu	Ürün Kodu	Kablo Kesit (mm ²)	Boyutlar			Kutu Adet	Birim Fiyat TL / Adet
			A	B	C		
3465	EKMUF - 10	10	4.7	6.6	30.0	1.000	7.30
3466	EKMUF - 16	16	5.5	7.0	35.0	500	7.30
3467	EKMUF - 25	25	7.0	9.0	40.0	300	15.00
3468	EKMUF - 35	35	8.5	10.5	45.0	200	20.00
3469	EKMUF - 50	50	10.0	12.0	50.0	100	28.00
3470	EKMUF - 70	70	11.5	14.0	55.0	75	43.00
3471	EKMUF - 95	95	13.5	16.0	60.0	50	53.00
3472	EKMUF - 120	120	15.5	18.0	65.0	50	68.00
3473	EKMUF - 150	150	16.5	20.0	70.0	30	118.00
3474	EKMUF - 185	185	18.5	22.0	75.0	25	137.00
3475	EKMUF - 240	240	21.5	25.5	85.0	20	197.00
3492	EKMUF - 300	300	23.5	28.5	100.0	15	300.00

DELİKLİ MONTAJ RAYLARI



Malzeme : Galvaniz Kaplama
Dış Genişlik : 35mm
İç Genişlik : 27mm



Sipariş Kodu	Ürün Kodu	Uzunluk	Kutu Adet	Birim Fiyat TL / Adet
3494	GW - MR 030	30 cm	150	16.00
3495	GW - MR 1	1 m	50	43.00
3496	GW - MR 2	2 m	30	86.00

DÜZ MONTAJ RAYLARI



Malzeme : Galvaniz Kaplama
Dış Genişlik : 35mm
İç Genişlik : 27mm



Sipariş Kodu	Ürün Kodu	Uzunluk	Kutu Adet	Birim Fiyat TL / Adet
3497	GW - MRD 030	30 cm	150	16.00
3498	GW - MRD 1	1 m	50	43.00
3499	GW - MRD 2	2 m	30	86.00

MONOFAZE MÜŞTEREK W OTOMAT BARALARI



Sipariş Kodu	Ürün Kodu	Bakır Kalınlığı	Boy	Modül	Amper	Kutu Adet	Fiyat TL / Adet
3599	M - 5308	0.8 mm	53 cm	30 Otomat için	63 A	60	110.00
3600	M - 10608	0.8 mm	106 cm	60 Otomat için	63 A	60	220.00
3601	M - 531	1 mm	53 cm	30 Otomat için	80 A	60	135.00
3602	M - 1061	1 mm	106 cm	60 Otomat için	80 A	60	270.00
3603	M - 5315	1.5 mm	53 cm	30 Otomat için	100 A	60	200.00
3604	M - 10615	1.5 mm	106 cm	60 Otomat için	100 A	60	400.00

TRİFAZE MÜŞTEREK W OTOMAT BARALARI

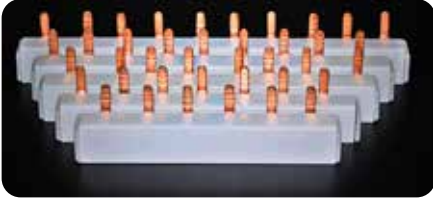

Sipariş Kodu	Ürün Kodu	Bakır Kalınlığı	Boy	Modül	Amper	Kutu Adet	Fiyat TL / Adet
3632	T - 5308	0.8 mm	53 cm	10 Grup için	63 A	24	340.00
3633	T - 10608	0.8 mm	106 cm	20 Grup için	63 A	24	680.00
3608	T - 531	1 mm	53 cm	10 Grup için	80 A	24	400.00
3609	T - 1061	1 mm	106 cm	20 Grup için	80 A	24	800.00
3613	T - 5315	1,5 mm	53 cm	10 Grup için	100 A	24	600.00
3614	T - 10615	1,5 mm	106 cm	20 Grup için	100 A	24	1.200.00
3627		Gwest - KAP		Monofaze Bara Kapağı			6.50
3628		Gwest - KAP		Trifaze Bara Kapağı			6.50

İSTEDİĞİNİZ ÖLÇÜDE KESİM YAPILIR.

2 KUTUPLU DAĞITICI ÜNİTELER

Birim Fiyat TL / Adet	190.00	
Sipariş Kodu	3701	
Ürün Kodu	GW - 2x7	
Akım	125 Amper	
Kablo Cinsi	Tek Damar	Çok Tellî
Kablo Kesit (mm ²)	Giriş	Çıkış
	1x10-35 mm ²	1x10-25 mm ² 5x2,5-6 mm ²
	1x10-16 mm ²	1x6-16 mm ² 5x1,5-6 mm ²
Ambalaj Adet	Paket	Koli
	1	138



Birim Fiyat TL / Adet	270.00	
Sipariş Kodu	3702	
Ürün Kodu	GW - 2x11	
Akım	125 Amper	
Kablo Cinsi	Tek Damar	Çok Tellî
Kablo Kesit (mm ²)	Giriş	Çıkış
	2x10-35 mm ²	2x10-25 mm ² 7x2,5-6 mm ²
	2x10-16 mm ²	2x6-16 mm ² 7x1,5-6 mm ²
Ambalaj Adet	Paket	Koli
	1	84



Birim Fiyat TL / Adet	350.00	
Sipariş Kodu	3703	
Ürün Kodu	GW - 2x15	
Akım	125 Amper	
Kablo Cinsi	Tek Damar	Çok Tellî
Kablo Kesit (mm ²)	Giriş	Çıkış
	2x10-35 mm ²	2x10-25 mm ² 11x2,5-6 mm ²
	2x10-16 mm ²	2x6-16 mm ² 11x1,5-6 mm ²
Ambalaj Adet	Paket	Koli
	1	72



4 KUTUPLU DAĞITICI ÜNİTELER



Birim Fiyat TL / Adet	350.00	
Sipariş Kodu	3704	
Ürün Kodu	GW - 4x7	
Akım	125 Amper	
Kablo Cinsi	Tek Damar	Çok Telli
Kablo Kesit (mm ²)	Giriş	Çıkış
	1x10-35 mm ²	1x10-25 mm ² 5x2,5-6 mm ²
	1x10-16 mm ²	1x6-16 mm ² 5x1,5-6 mm ²
Ambalaj Adet	Paket	Koli
	1	74



Birim Fiyat TL / Adet	520.00	
Sipariş Kodu	3705	
Ürün Kodu	GW - 4x11	
Akım	125 Amper	
Kablo Cinsi	Tek Damar	Çok Telli
Kablo Kesit (mm ²)	Giriş	Çıkış
	2x10-35 mm ²	2x10-25 mm ² 7x2,5-6 mm ²
	2x10-16 mm ²	2x6-16 mm ² 7x1,5-6 mm ²
Ambalaj Adet	Paket	Koli
	1	50



Birim Fiyat TL / Adet	650.00	
Sipariş Kodu	3706	
Ürün Kodu	GW - 4x15	
Akım	125 Amper	
Kablo Cinsi	Tek Damar	Çok Telli
Kablo Kesit (mm ²)	Giriş	Çıkış
	2x10-35 mm ²	2x10-25 mm ² 11x2,5-6 mm ²
	2x10-16 mm ²	2x6-16 mm ² 11x1,5-6 mm ²
Ambalaj Adet	Paket	Koli
	1	40



Birim Fiyat TL / Adet	1.550.00	
Sipariş Kodu	3707	
Ürün Kodu	GW - 4x12/160A	
Akım	160 Amper	
Kablo Cinsi	Tek Damar	Çok Telli
Kablo Kesit (mm ²)	Giriş	Çıkış
	1x10-50 mm ²	3x10-35 mm ² 8x2,5-16 mm ²
	1x10-50 mm ²	3x6-25 mm ² 8x1,5-16 mm ²
Ambalaj Adet	Paket	Koli
	1	18

TEK KUTUPLU DAĞITICI ÜNİTELER

Birim Fiyat TL / Adet	160.00	
Sipariş Kodu	3708	
Ürün Kodu	GW - 80A	
Akım	80 Amper	
Kablo Kesit (mm ²)	Giriş	Çıkış
	1x10-16 mm ²	4x2,5-6 mm ² 2x2,5-16 mm ²
Ambalaj Adet	Paket	Koli
	5	250



Birim Fiyat TL / Adet	325.00	
Sipariş Kodu	3709	
Ürün Kodu	GW - 125A	
Akım	125 Amper	
Kablo Kesit (mm ²)	Giriş	Çıkış
	1x10-35 mm ²	6x2,5-16 mm ² Köprü 1x6-16 mm ²
Ambalaj Adet	Paket	Koli
	5	160



Birim Fiyat TL / Adet	330.00	
Sipariş Kodu	3710	
Ürün Kodu	GW - 160A	
Akım	160 Amper	
Kablo Kesit (mm ²)	Giriş	Çıkış
	1x10-70 mm ²	6x2,5-16 mm ² Köprü 1x6-16 mm ²
Ambalaj Adet	Paket	Koli
	5	160



TEK KUTUPLU DAĞITICI ÜNİTELER

Birim Fiyat TL / Adet	950.00	
Sipariş Kodu	3711	
Ürün Kodu	GW - 250A	
Akım	250 Amper	
Kablo Kesit (mm ²)	Giriş	Çıkış
	1x35-120 mm ²	4x2,5-10 mm ² 5x2,5-16 mm ² 2x6-35 mm ²
Ambalaj Adet	Paket	Koli
	3	54



Birim Fiyat TL / Adet	1.000.00	
Sipariş Kodu	3712	
Ürün Kodu	GW - 400A	
Akım	400 Amper	
Kablo Kesit (mm ²)	Giriş	Çıkış
	1x95-185 mm ²	4x2,5-10 mm ² 5x2,5-16 mm ² 2x6-35 mm ²
Ambalaj Adet	Paket	Koli
	3	54



Birim Fiyat TL / Adet	1.100.00	
Sipariş Kodu	3713	
Ürün Kodu	GW - 500A	
Akım	500 Amper	
Kablo Kesit (mm ²)	Giriş	Çıkış
	8x24 mm ²	4x2,5-10 mm ² 5x2,5-16 mm ² 2x6-35 mm ²
Ambalaj Adet	Paket	Koli
	3	54





KOMPAKT KLEMENSLER

Geçmeli ve Çok Amaçlı



GEÇMELİ BUAT KLEMENSLER

	Sipariş Kodu	Ürün Kodu	Renk	Kablo Kesiti	Ebatlar			Ambalaj Adet		Birim Fiyat TL / Adet
					En	Boy	Yükseklik	Paket	Koli	
	3501	GW 2,5 - 2	Beyaz	0,50 - 2,5 mm ²	9.8	16.4	5.8	200	10.000	4.00
	3502	GW 2,5 - 3	Turuncu	0,50 - 2,5 mm ²	13.9	16.4	5.8	200	10.000	4.20
	3503	GW 2,5 - 4	Kırmızı	0,50 - 2,5 mm ²	17.9	16.4	5.8	100	5.000	4.80
	3504	GW 2,5 - 5	Sarı	0,50 - 2,5 mm ²	21.9	16.4	5.8	100	5.000	5.60
	3505	GW 2,5 - 6	Kırmızı	0,50 - 2,5 mm ²	13.8	16.4	11.25	100	5.000	7.00
	3506	GW 2,5 - 8	Gri	0,50 - 2,5 mm ²	17.8	16.4	11.25	100	5.000	8.00

ÇOK AMAÇLI KLEMENSLER

	Sipariş Kodu	Ürün Kodu	Kablo Kesiti	Açıklama	Ambalaj Adet		Birim Fiyat TL / Adet
					Paket	Koli	
	3507	GW - 412	0,14 - 4,0 mm ²	2 İletken Bağlantılı	100	5.000	7.10
	3508	GW - 413	0,14 - 4,0 mm ²	3 İletken Bağlantılı	100	5.000	9.50
	3509	GW - 414	0,14 - 4,0 mm ²	4 İletken Bağlantılı	50	2.500	11.50
	3510	GW - 415	0,14 - 4,0 mm ²	5 İletken Bağlantılı	50	2.500	14.00

Çalışma Sıcaklığı: -40°C + 105°C

Nominal Akım : 32A

Nominal Gerilim : 450V



MAKARON GRUBU

Ve Kablo orabı



www.guvenelektrik.com.tr

ISI İLE DARALAN SİYAH MAKARONLAR

TEKNİK ÖZELLİKLER



Malzeme : Polyolefin

Daralma Oranı : 2/1

Yanmazlık : Kendi kendine söner

Çalışma Sıcaklığı : -55°C -- +125°C

Sipariş Kodu	Ölçü		Daralmadan Önce (mm)		Daralmadan Sonra (mm)		Makara / Mt.	Koli Miktarı	Birim Fiyat USD / Mt.
	İnch	mm	İç Çap	Cidar Kalınlığı	İç Çap	Cidar Kalınlığı			
4015	----	1	2,0 ± 0,3	0,16 ± 0,05	0,70	0,30 ± 0,05	200	3.200	0.085
4016	----	1,5	2,0 ± 0,3	0,16 ± 0,05	0,80	0,30 ± 0,05	200	2.400	0.097
4017	----	2	2,5 ± 0,3	0,16 ± 0,05	1,00	0,35 ± 0,05	200	3.000	0.115
4003	3/32	2,4	3,0 ± 0,3	0,16 ± 0,05	1,50	0,35 ± 0,05	200	3.000	0.115
4018	----	2,5	3,0 ± 0,3	0,16 ± 0,05	1,25	0,38 ± 0,05	200	2.600	0.15
4019	----	3	3,5 ± 0,4	0,20 ± 0,05	1,50	0,38 ± 0,05	200	2.200	0.16
4004	1/8	3,2	3,5 ± 0,4	0,20 ± 0,05	1,75	0,40 ± 0,05	200	2.200	0.16
4020	----	3,5	4,0 ± 0,4	0,20 ± 0,05	1,75	0,40 ± 0,05	200	1.800	0.17
4021	----	4	4,5 ± 0,4	0,20 ± 0,05	2,00	0,45 ± 0,05	200	1.400	0.20
4022	----	4,5	4,8 ± 0,4	0,20 ± 0,05	2,00	0,47 ± 0,08	200	1.200	0.23
4005	3/16	4,8	5,2 ± 0,4	0,20 ± 0,05	2,60	0,47 ± 0,08	200	1.200	0.23
4023	----	5	5,5 ± 0,4	0,20 ± 0,05	2,50	0,55 ± 0,08	200	1000	0.25
4024	----	6	6,5 ± 0,4	0,22 ± 0,05	3,00	0,55 ± 0,08	200	800	0.29
4006	1/4	6,4	7,0 ± 0,4	0,28 ± 0,05	3,50	0,55 ± 0,08	200	800	0.29
4025	----	7	7,5 ± 0,4	0,28 ± 0,05	3,50	0,60 ± 0,08	100	500	0.35
4026	----	8	8,5 ± 0,4	0,30 ± 0,08	4,00	0,60 ± 0,08	100	1.300	0.35
4007	3/8	9,5	10,0 ± 0,5	0,30 ± 0,08	5,00	0,60 ± 0,08	100	1.200	0.35
4028	----	10	10,0 ± 0,5	0,30 ± 0,08	5,00	0,60 ± 0,08	100	1.100	0.39
4008	1/2	12,7	13,0 ± 0,5	0,33 ± 0,10	6,50	0,65 ± 0,08	100	1.000	0.45
4031	----	13	13,5 ± 0,5	0,33 ± 0,10	6,50	0,65 ± 0,08	100	900	0.48
4032	----	14	14,5 ± 0,5	0,33 ± 0,10	7,00	0,70 ± 0,08	100	900	0.56
4034	4/5	16	16,5 ± 0,6	0,35 ± 0,12	8,00	0,75 ± 0,08	100	800	0.75
4036	----	18	19,0 ± 0,6	0,40 ± 0,15	9,00	0,80 ± 0,15	100	700	0.98
4009	3/4	19,1	20,5 ± 0,6	0,40 ± 0,15	10,00	0,80 ± 0,15	100	700	0.98
4038	----	20	20,5 ± 0,6	0,40 ± 0,15	10,00	0,80 ± 0,15	100	600	1.25
4039	----	22	22,5 ± 0,7	0,45 ± 0,15	12,00	0,95 ± 0,15	100	600	1.55
4010	1	25,4	25,6 ± 0,7	0,45 ± 0,15	12,00	0,95 ± 0,15	50	300	1.65
4040	----	30	31,5 ± 0,7	0,50 ± 0,15	15,00	0,95 ± 0,15	50	250	2.15
4011	1 - 1/4	32	33,0 ± 0,7	0,50 ± 0,15	16,50	0,95 ± 0,15	50	250	2.15
4041	----	35	38,0 ± 0,7	0,50 ± 0,15	16,00	1,00 ± 0,15	50	200	2.70
4012	1 - 1/2	38	40,0 ± 0,7	0,50 ± 0,15	20,00	1,00 ± 0,15	50	200	3.00
4042	----	40	40,5 ± 0,7	0,50 ± 0,15	20,00	1,00 ± 0,15	50	200	3.00
4013	2	51	52,5 ± 0,7	0,50 ± 0,15	25,00	1,00 ± 0,15	25	125	3.80
4043	----	60	60,5 ± 0,8	0,52 ± 0,15	30,00	1,00 ± 0,16	25	100	5.10
4044	----	70	70,5 ± 1,0	0,55 ± 0,15	40,00	1,10 ± 0,18	25	75	6.80
4045	----	80	82,0 ± 1,0	0,55 ± 0,15	40,00	1,10 ± 0,18	25	75	7.50
4050	----	90	90,0 ± 1,0	0,55 ± 0,15	45,00	1,10 ± 0,18	25	50	8.50
4046	4	102	105,0 ± 1,0	0,55 ± 0,15	51,00	1,10 ± 0,18	25	50	9.50
4047	----	120	120,0 ± 1,0	0,55 ± 0,15	60,00	1,10 ± 0,18	25	50	13.00
4048	----	150	150,0 ± 1,0	0,55 ± 0,15	76,00	1,10 ± 0,18	25	50	19.00
4049	----	180	180,0 ± 1,0	0,55 ± 0,15	90,00	1,10 ± 0,18	25	25	27.00

ISI İLE DARALAN RENKLİ MAKARONLAR

ŞEFFAF - BEYAZ - KIRMIZI - MAVİ - SARI - YEŞİL - GRİ

Ölçü		Sipariş Kodu							Makara / Mt.	Koli Miktarı	Fiyat Usd / Mt.
İnch	mm	ŞEFFAF	BEYAZ	KIRMIZI	MAVİ	SARI	YEŞİL	GRİ			
---	1,5	4201	4289	4219	4237	4254	4272	4306	200	3.200	0.11
---	2,5	4202	4290	4220	4238	4256	4273	4307	200	2.600	0.17
1/8	3,2	4203	4291	4221	4239	4257	4274	4308	200	2.200	0.20
---	3,5	---	4292	---	---	4258	---	---	200	1.800	0.21
Yassı	3,5	---	4395	---	---	4390	---	---	100	1.600	0.21
3/16	4,8	4204	4293	4222	4240	4259	4275	4309	100	1.000	0.27
Yassı	4,8	---	4396	---	---	4391	---	---	100	1.500	0.27
1/4	6,4	4205	4294	4224	4241	4260	4276	4310	100	700	0.33
Yassı	6,4	---	4397	---	---	4392	---	---	100	1.500	0.33
Yassı	7	---	4398	---	---	4393	---	---	100	1.400	0.33
3/8	9,5	4206	4295	4226	4242	4261	4278	4311	100	1.200	0.39
---	13	4208	4296	4227	4243	4262	4279	4312	100	900	0.55
4/5	16	4209	4297	4228	4244	4263	4280	4313	100	800	0.85
---	20	4210	4298	4229	4245	4264	4281	4314	100	600	1.50
1	25,4	4211	4299	4230	4246	4265	4282	4315	50	300	1.90
1 - 1/4	32	4212	4300	4231	4247	4266	4283	4316	50	250	2.40
1 - 1/2	38	4213	4301	4232	4248	4267	4284	4317	50	200	3.60
2	51	4214	4302	4233	4249	4268	4285	4318	25	125	4.20
---	60	4215	4303	4234	4250	4269	4286	4319	25	100	5.80
---	80	4216	4304	4235	4251	4270	4287	4320	25	75	8.00
4	102	4217	4305	4236	4252	4271	4288	4321	25	50	11.00

TEKNİK ÖZELLİKLER

- **Malzeme** : Polyolefin
- **Daralma Oranı** : 2/1
- **Yanmazlık** : Kendi kendine söner
- **Çalışma Sıcaklığı** : -55°C -- +125°C



ISI İLE DARALAN RENKLİ MAKARONLAR KAHVERENGİ

Sipariş Kodu	Ölçü		Daralmadan Önce (mm)		Daralmadan Sonra (mm)		Makara / Mt.	Koli Miktarı	Birim Fiyat USD / Mt.
	İnch	mm	İç Çap	Cidar Kalınlığı	İç Çap	Cidar Kalınlığı			
4322	---	1,5	2,0 ± 0,3	0,16 ± 0,05	0,80	0,30 ± 0,05	200	3.200	0.12
4323	---	2,5	3,0 ± 0,3	0,16 ± 0,05	1,25	0,38 ± 0,05	200	2.600	0.18
4324	1/8	3,2	3,5 ± 0,4	0,20 ± 0,05	1,75	0,40 ± 0,05	200	2.200	0.22
4325	3/16	4,8	5,2 ± 0,4	0,20 ± 0,05	2,60	0,47 ± 0,08	100	1.000	0.29
4326	1/4	6,4	7,0 ± 0,4	0,28 ± 0,05	3,50	0,55 ± 0,08	100	700	0.38
4327	3/8	9,5	10,0 ± 0,5	0,30 ± 0,08	5,00	0,60 ± 0,08	100	1.200	0.44
4328	---	13	13,5 ± 0,5	0,33 ± 0,10	6,50	0,65 ± 0,08	100	900	0.60
4329	4/5	16	16,5 ± 0,6	0,35 ± 0,12	8,00	0,75 ± 0,08	100	800	1.05
4330	---	20	20,5 ± 0,6	0,40 ± 0,15	10,00	0,80 ± 0,15	100	600	1.55
4331	1	25,4	25,6 ± 0,7	0,45 ± 0,15	12,00	0,95 ± 0,15	50	300	2.10
4332	1 - 1/4	32	33,0 ± 0,7	0,50 ± 0,15	16,50	0,95 ± 0,15	50	250	2.80
4333	1 - 1/2	38	40,0 ± 0,7	0,50 ± 0,15	20,00	1,00 ± 0,15	50	200	4.10
4334	2	51	52,5 ± 0,7	0,50 ± 0,15	25,00	1,00 ± 0,15	25	125	4.90
4335	---	60	60,5 ± 0,8	0,52 ± 0,15	30,00	1,00 ± 0,16	25	100	7.50
4336	---	80	82,0 ± 1,0	0,55 ± 0,15	40,00	1,10 ± 0,18	25	75	9.00
4337	4	102	105,0 ± 1,0	0,55 ± 0,15	51,00	1,10 ± 0,18	25	50	13.50



TEKNİK ÖZELLİKLER

- **Malzeme** : Polyolefin
- **Daralma Oranı** : 2/1
- **Yanmazlık** : Kendi kendine söner
- **Çalışma Sıcaklığı** : -55°C -- +125°C



ISI İLE DARALAN RENKLİ MAKARONLAR

SARI YEŞİL

Sipariş Kodu	Ölçü		Daralmadan Önce (mm)		Daralmadan Sonra (mm)		Makara / Mt.	Koli Miktarı	Birim Fiyat USD / Mt.
	İnch	mm	İç Çap	Cidar Kalınlığı	İç Çap	Cidar Kalınlığı			
4102	3/32	2,4	3,0 ± 0,3	0,16 ± 0,05	1,50	0,35 ± 0,05	200	3.000	0.42
4103	1/8	3,2	3,5 ± 0,4	0,20 ± 0,05	1,75	0,40 ± 0,05	200	2.200	0.43
4104	3/16	4,8	5,2 ± 0,4	0,20 ± 0,05	2,60	0,47 ± 0,08	100	1.000	0.44
4105	1/4	6,4	7,0 ± 0,4	0,28 ± 0,05	3,50	0,55 ± 0,08	100	700	0.50
4106	3/8	9,5	10,0 ± 0,5	0,30 ± 0,08	5,00	0,60 ± 0,08	100	1.200	0.68
4107	---	13	13,5 ± 0,5	0,33 ± 0,10	6,50	0,65 ± 0,08	100	900	1.00
4108	4/5	16	16,5 ± 0,6	0,35 ± 0,12	8,00	0,75 ± 0,08	100	800	1.45
4109	---	20	20,5 ± 0,6	0,40 ± 0,15	10,00	0,80 ± 0,15	100	600	1.90
4110	1	25,4	25,6 ± 0,7	0,45 ± 0,15	12,00	0,95 ± 0,15	50	300	2.75
4111	1 - 1/4	32	33,0 ± 0,7	0,50 ± 0,15	16,50	0,95 ± 0,15	50	250	3.70
4112	1 - 1/2	38	40,0 ± 0,7	0,50 ± 0,15	20,00	1,00 ± 0,15	50	200	5.00
4113	2	51	52,5 ± 0,7	0,50 ± 0,15	25,00	1,00 ± 0,15	50	125	7.00
4114	---	60	60,5 ± 0,8	0,52 ± 0,15	30,00	1,00 ± 0,16	25	100	10.00
4115	---	80	82,0 ± 1,0	0,55 ± 0,15	40,00	1,10 ± 0,18	25	75	15.00
4116	4	102	105,0 ± 1,0	0,55 ± 0,15	51,00	1,10 ± 0,18	25	50	23.00



TEKNİK ÖZELLİKLER

- **Malzeme :** Polyolefin
- **Daralma Oranı :** 2/1
- **Yanmazlık :** Kendi kendine söner
- **Çalışma Sıcaklığı :** -55°C -- +125°C



İÇİ YAPIŞKANLI DARALAN MAKARONLAR

Sipariş Kodu	Ölçü mm	Daralmadan Önce (mm)	Daralmadan Sonra (mm)			Makara / Mt.	Koli Miktarı	Birim Fiyat USD / Mt.
		İç Çap	Azami İç Çap	Anma Cıdar Kalınlığı	Anma Yapışkanlığı			
4418	3/1	3	1.00	1.10 ± 0.10	0.50	200	1.800	0.65
4419	4.8/1.5	4.8	1.50	1.20 ± 0.10	0.50	100	900	0.80
4420	6/2	6	2.00	1.30 ± 0.10	0.50	100	600	1.20
4421	9/3	9	3.00	1.70 ± 0.15	0.60	50	300	1.60
4405	12/4	12	4.00	2.00 ± 0.20	0.80	1.20 Boy	250	2.30
4406	16/5	16	5.00	2.20 ± 0.20	0.80	1.20 Boy	250	3.20
4407	19/6	19	6.00	2.30 ± 0.20	0.80	1.20 Boy	150	4.50
4408	28/9	28	9.00	2.40 ± 0.20	1.05	1.20 Boy	110	5.10
4409	33/10	33	10.00	2.50 ± 0.20	1.05	1.20 Boy	100	5.80
4410	40/12	40	12.00	2.50 ± 0.20	1.05	1.20 Boy	70	6.40
4411	44/14	44	14.00	2.50 ± 0.20	1.05	1.20 Boy	60	7.10
4412	52/18	52	18.00	2.50 ± 0.20	1.05	1.20 Boy	60	8.00
4414	70/25	70	25.00	3.00 ± 0.30	1.35	1.20 Boy	32	11.30
4415	90/30	90	30.00	3.00 ± 0.30	1.35	1.20 Boy	24	16.00
4416	125/40	125	40.00	3.00 ± 0.30	1.35	1.20 Boy	20	20.00



TEKNİK ÖZELLİKLER

- **Malzeme :** Polyolefin
- **Daralma Oranı :** 3/1
- **Yanmazlık :** Kendi kendine söner
- **Çalışma Sıcaklığı :** -55°C -- +125°C



KABLO TOPLAMA ÇORABI

Sipariş Kodu	Ölçü	Renk	Esneleme Aralığı		Makara / Mt.	Birim Fiyat USD / Mt.
			Min (mm)	Max (min)		
4501	3 mm	Siyah	1	6	100	0.24
4502	6 mm	Siyah	3	9	100	0.29
4503	8 mm	Siyah	5	16	100	0.30
4504	10 mm	Siyah	7	19	100	0.36
4505	12 mm	Siyah	8	24	100	0.43
4506	15 mm	Siyah	10	27	100	0.48
4507	20 mm	Siyah	14	30	100	0.56
4508	25 mm	Siyah	18	35	100	0.72
4509	30 mm	Siyah	20	50	50	0.87
4510	40 mm	Siyah	30	60	50	1.14
4511	50 mm	Siyah	40	80	25	1.40

TEKNİK ÖZELLİKLER

- **Malzeme :** Pet (Polyester)
- **Çalışma Sıcaklığı :** -50°C -- +150°C
- **Dayanım Üst Noktası :** 220 °C
- **Erime Noktası :** +250 °C

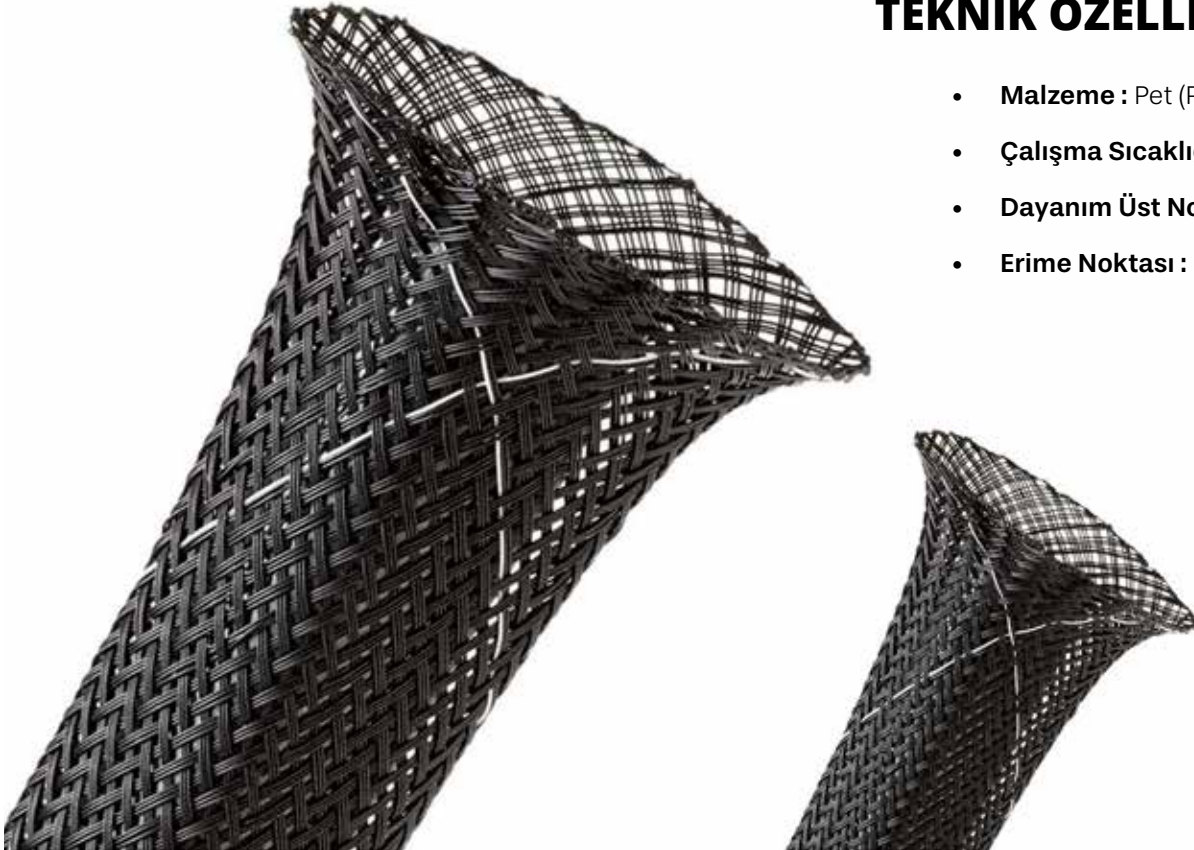

H CLASS CAM ELYAF SİLİKON İZOLELİ MAKARONLAR

Sipariş Kodu	Ölçü	Renk	Makara / Mt.	Koli Miktarı	Birim Fiyat USD / Mt.
4703	2 mm	Kırmızı	200	4.000	0.22
4705	3 mm	Kırmızı	100	2.500	0.34
4706	4 mm	Kırmızı	100	1.500	0.46
4707	5 mm	Kırmızı	100	1.200	0.55
4708	6 mm	Kırmızı	100	1.000	0.68
4709	7 mm	Kırmızı	100	800	0.78
4710	8 mm	Kırmızı	50	500	0.90
4711	10 mm	Kırmızı	50	500	1.23
4712	12 mm	Kırmızı	50	500	1.53
4713	14 mm	Kırmızı	50	500	1.83
4714	16 mm	Kırmızı	25	500	2.45
4715	18 mm	Kırmızı	25	400	3.20
4716	20 mm	Kırmızı	25	400	4.10
4717	25 mm	Kırmızı	25	350	7.80
4718	30 mm	Kırmızı	25	200	11.50
4719	35 mm	Kırmızı	25	200	13.50



TEKNİK ÖZELLİKLER

- Malzeme :** Silikon İzoleli Cam Elyaf Örgü Makaron
- Çalışma Sıcaklığı :** -60 °C -- +250 °C



MEKANİK VE HİDROLİK El Aletleri



YÜKSÜK SIKMA PENSELERİ

Sipariş Kodu: 5026

Ürün Kodu: GW – B4

0.25 – 6 mm² Yüksek Sıkma Pensesi

66.00 USD

Sipariş Kodu: 5006

Ürün Kodu: GW – 6

6 – 16 mm² Yüksek Sıkma Pensesi

69.00 USD

Sipariş Kodu: 5005

Ürün Kodu: GW – 5

0.50 – 6 mm² Yüksek Sıkma Pensesi

69.00 USD

Sipariş Kodu: 5008

Ürün Kodu: GW – 8

0.08 – 6 mm² Yüksek Sıkma Pensesi (4 Köşe)

90.00 USD

Sipariş Kodu: 5009

Ürün Kodu: GW – 9

0.08 – 6 mm² Yüksek Sıkma Pensesi (6 Köşe)

105.00 USD

Sipariş Kodu: 5015

Ürün Kodu: GW – 17

25 – 35 mm² Yüksek Sıkma Pensesi

73.00 USD

İZOLESİZ KABLO UCU VE KONNEKTÖR SIKMA PENSELERİ

Sipariş Kodu: 5021

Ürün Kodu: GW - 11

0.50 - 6 mm² İzolesiz Terminal Sıkma Pensesi

70.00 USD

Sipariş Kodu: 5022

Ürün Kodu: GW - 12

1.00 - 10 mm² İzolesiz Terminal Sıkma Pensesi

70.00 USD

Sipariş Kodu: 5013

Ürün Kodu: GW - 13

28 - 22 / 24 - 18 (Molex) Konnektör Ucu Sıkma Pensesi (AWG)



73.00 USD

İZOLELİ KABLO UCU SIKMA PENSELERİ

Sipariş Kodu: 5016

Ürün Kodu: GW - 1

0.50 - 6 mm² İzoleli Kablo Ucu Sıkma Pensesi

59.00 USD

Sipariş Kodu: 5017

Ürün Kodu: GW - 7

0.50 - 6 mm² İzoleli Kablo Ucu Sıkma Pensesi

70.00 USD

MULTİ FONKSİYONEL YÜKSÜK VE KABLO UCU SIKMA PENSESİ

Sipariş Kodu: 5070

Ürün Kodu: T03C - 5D

Takım İçerikli Çanta

Takım İçeriği

- GW - 5 Yüksük Sıkma 0.5 - 6 mm
- GW - 6 Yüksük Sıkma 6 - 16 mm
- GW - 1 Kablo Ucu Sıkma 0.5 - 6 mm
- GW - 11 İzolesiz Terminal Sıkma 1 - 4mm
- GW - T8 Kaynaklı Papuç Sıkma 0.5 - 10mm

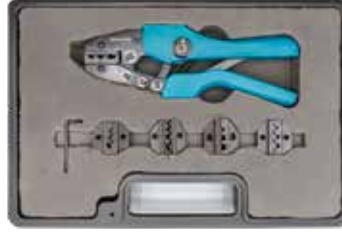

160.00 USD

KABLO SIYIRMA PENSESİ

Sipariş Kodu: 5028

Ürün Kodu: GW - 318

0.50 - 6 mm² Kablo Siyirma Pensesi

33.00 USD

KABLO BAĞI SIKMA PENSELERİ

Sipariş Kodu: 5054

Ürün Kodu: TG - 008

2.2 - 4.8 mm² Kablo Bağı Sıkma Pensesi

65.00 USD

Sipariş Kodu: 5055

Ürün Kodu: TG - 009

3.6 - 9 mm² Kablo Bağı Sıkma Pensesi

44.00 USD

Sipariş Kodu: 5056

Ürün Kodu: TG - 011

4.6 - 12 mm² Metal Kablo Bağı Sıkma Pensesi

178.00 USD

KABLO PABUCU SIKMA PENSELERİ

Sipariş Kodu: 5018

Ürün Kodu: GW - T8

1.5 - 10 mm² SKP Sıkma Pensesi**60.00 USD**

Sipariş Kodu: 5019

Ürün Kodu: GW - T9

10 - 16 mm² SKP Sıkma Pensesi**60.00 USD**

Sipariş Kodu: 5045

Ürün Kodu: JY - 0650

6 - 50 mm² SKP Sıkma Pensesi**82.00 USD**

Sipariş Kodu: 5046

Ürün Kodu: JY - 06120

10 - 120 mm² SKP Sıkma Pensesi**165.00 USD**

HİDROLİK KABLO PABUCU SIKMA PENSELERİ

Sipariş Kodu: 5050

Ürün Kodu: YOQ 120

10 - 120 mm² Hidrolik SKP Sıkma Pensesi (Çantalı Set)**150.00 USD**

Sipariş Kodu: 5051

Ürün Kodu: YQK 300

16 - 300 mm² Hidrolik SKP Sıkma Pensesi (Çantalı Set)**160.00 USD**

KABLO KESME MAKASLARI

Sipariş Kodu: 5040

Ürün Kodu: CC- 60

60 mm² Kablo Kesme Makası

43.00 USD

Sipariş Kodu: 5041

Ürün Kodu: TC- 100

120 mm² Kablo Kesme Makası

72.00 USD

Sipariş Kodu: 5042

Ürün Kodu: TC- 250

250 mm² Kablo Kesme Makası

135.00 USD

Sipariş Kodu: 5044

Ürün Kodu: TC - 500

630 mm² Kablo Kesme Makası

195.00 USD

Sipariş Kodu: 5067

Ürün Kodu: TCR- 325

325 mm² Bakır ve Alüminyum Kablo Kesme Makası

195.00 USD

Sipariş Kodu: 5069

Ürün Kodu: ZCR - 52

500 mm² Çok Telli Kablo Kesme Makası

330.00 USD



BUTON SERİSİ

Ve Aksesuarları





Ø 22mm BUTON SERİSİ YAYLI BUTONLAR

Sipariş Kodu	Ürün Kodu	Kontakt	Açıklama	Renk	Kutu Adet	Koli Adet	Birim Fiyat TL / Ad.
	6001	A5 - 10	1NO	Yeşil	10	300	77.00
	6002	A5 - 01	1NC	Kırmızı	10	300	77.00
	6003	A5 - 11	1NO	Sarı	10	300	77.00
	6004	A5 - 21	1NO	Mavi	10	300	77.00
	6005	A5 - 31	1NO	Beyaz	10	300	77.00
	6006	A5 - 41	1NO	Siyah	10	300	77.00

İŞARETLİ YAYLI BUTONLAR



	6007	A5 - 10/1	1NO	İşaretili Yaylı Buton	10	300	90.00
	6008	A5 - 01/2	1NC	İşaretili Yaylı Buton	10	300	90.00
	6009	A5 - 10/3	1NO	İşaretili Yaylı Buton	10	300	90.00
	6010	A5 - 10/4	1NO	İşaretili Yaylı Buton	10	300	90.00

İŞIKLI YAYLI BUTONLAR



	6011	A5 - 10D	1NO	Işıklı Yaylı Buton 220V AC/DC	Yeşil	10	300	144.00
	6012	A5 - 01D	1NC		Kırmızı	10	300	144.00
	6013	A5 - 11D	1NO		Sarı	10	300	144.00
	6014	A5 - 21D	1NO		Mavi	10	300	144.00
	6015	A5 - 31D	1NO		Beyaz	10	300	144.00
	6016	A5 - 10D-110	1NO	Işıklı Yaylı Buton 110V AC/DC	Yeşil	10	300	144.00
	6017	A5 - 01D-110	1NC		Kırmızı	10	300	144.00
	6018	A5 - 11D-110	1NO		Sarı	10	300	144.00
	6019	A5 - 21D-110	1NO		Mavi	10	300	144.00
	6020	A5 - 31D-110	1NO		Beyaz	10	300	144.00
	6021	A5 - 10D-24	1NO	Işıklı Yaylı Buton 24V AC/DC	Yeşil	10	300	144.00
	6022	A5 - 01D-24	1NC		Kırmızı	10	300	144.00
	6023	A5 - 11D-24	1NO		Sarı	10	300	144.00
	6024	A5 - 21D-24	1NO		Mavi	10	300	144.00
	6025	A5 - 31D-24	1NO		Beyaz	10	300	144.00

Ø 22mm BUTON SERİSİ

KALICI MANDAL BUTONLAR

	Sipariş Kodu	Ürün Kodu	Kontakt	Açıklama	Kutu Adet	Koli Adet	Birim Fiyat TL / Ad.
	6027	A5 - 10X	1NO	0 -1 Mandal Buton		10	300
6028	A5 - 20XS	2NO	1-0-2 Mandal Buton		10	300	120.00



KAYICI MANDAL BUTONLAR

	Sipariş Kodu	Ürün Kodu	Kontakt	Açıklama	Kutu Adet	Koli Adet	Birim Fiyat TL / Ad.
	6029	A5 - 10X/FU	1NO	0 -1 Mandal Buton		10	300
6030	A5 - 20XS/FU	2NO	1-0-2 Mandal Buton		10	300	128.00

KALICI - KAYICI MANDAL BUTON













	Sipariş Kodu	Ürün Kodu	Kontakt	Açıklama	Kutu Adet	Koli Adet	Birim Fiyat TL / Ad.
	6026	A5 - 20XS/F	2NO	1-0-2 Mandal Buton Sağ Pozisyon Kalıcı Sol Pozisyon Kayıcı		10	300

ANAHTARLI KALICI BUTONLAR

	Sipariş Kodu	Ürün Kodu	Kontakt	Açıklama	Kutu Adet	Koli Adet	Birim Fiyat TL / Ad.
	6049	A5 - 10Y	1NO	0 -1 Anahtarlı Buton		10	300
6050	A5 - 20YS	2NO	1-0-2 Anahtarlı Buton		10	300	162.00

Ø 22mm BUTON SERİSİ

IŞIKLI KALICI MANDAL BUTONLAR

	Sipariş Kodu	Ürün Kodu	Kontakt	Açıklama	Renk	Kutu Adet	Koli Adet	Birim Fiyat TL / Ad.
	6031	A5 - 10XD	1NO	 O-1 Işıklı Mandal Buton 220V AC/DC	Yeşil	10	300	144.00
	6032	A5 - 01XD	1NC		Kırmızı	10	300	
	6033	A5 - 11XD	1NO		Sarı	10	300	
	6037	A5 - 10XD-110	1NO	 O-1 Işıklı Mandal Buton 110V AC/DC	Yeşil	10	300	144.00
	6038	A5 - 01XD-110	1NC		Kırmızı	10	300	
	6039	A5 - 11XD-110	1NO		Sarı	10	300	
	6043	A5 - 10XD-24	1NO	 O-1 Işıklı Mandal Buton 24V AC/DC	Yeşil	10	300	144.00
	6044	A5 - 01XD-24	1NC		Kırmızı	10	300	
	6045	A5 - 11XD-24	1NO		Sarı	10	300	
	6034	A5 - 20XSD	2NO	 1-0-2 Işıklı Mandal Buton 220V AC/DC	Yeşil	10	300	176.00
	6035	A5 - 02XSD	2NC		Kırmızı	10	300	
	6036	A5 - 21XSD	2NO		Sarı	10	300	
	6040	A5 - 20XSD-110	2NO	 1-0-2 Işıklı Mandal Buton 110V AC/DC	Yeşil	10	300	176.00
	6041	A5 - 02XSD-110	2NC		Kırmızı	10	300	
	6042	A5 - 21XSD-110	2NO		Sarı	10	300	
	6046	A5 - 20XSD-24	2NO	 1-0-2 Işıklı Mandal Buton 24V AC/DC	Yeşil	10	300	176.00
	6047	A5 - 02XSD-24	2NC		Kırmızı	10	300	
	6048	A5 - 21XSD-24	2NO		Sarı	10	300	

Ø 22mm BUTON SERİSİ

40mm KALICI MANTAR BUTON

	Sipariş Kodu	Ürün Kodu	Kontak	Açıklama	Renk	Kutu Adet	Koli Adet	Birim Fiyat TL / Ad.
	6054	A5 - 01ZS	1NC	Stop Mantar Buton	● Kırmızı	10	300	103.00

40mm KALICI ANAHTARLI MANTAR BUTON

	6075	BZ - 01ZA	1NC	Anahtarlı Stop Mantar Buton	● Kırmızı	10	300	150.00
--	------	-----------	-----	-----------------------------	-----------	----	-----	--------

40mm KAYICI MANTAR BUTONLAR

	6051	A5 - 01M	1NC	Stop Mantar Buton	● Kırmızı	10	300	90.00
	6052	A5 - 10M	1NO	Start Mantar Buton	● Yeşil	10	300	90.00
	6053	A5 - 41M	1NO	Start Mantar Buton	● Siyah	10	300	90.00









40mm KALICI MANTAR BUTONLAR

	6055	A5 - 01ZF	1NC	Stop Mantar Buton		10	300	177.00
	6058	A5 - 01ZFD	1NC	Led Işıklı Stop Mantar Buton 220V AC/DC		10	300	230.00
	6057	A5 - 01ZFD-110	1NC	Led Işıklı Stop Mantar Buton 110V AC/DC		10	300	230.00
	6056	A5 - 01ZFD-24	1NC	Led Işıklı Stop Mantar Buton 24V AC		10	300	230.00







İKİZ BUTONLAR

	6059	A5 - 11R	1NO+1NC	İkiz Buton		10	300	147.00
	6062	A5 - 11RD	1NO+1NC	Işıklı İkiz Buton 220V AC/DC		10	300	200.00
	6061	A5 - 11RD-110	1NO+1NC	Işıklı İkiz Buton 110V AC/DC		10	300	200.00
	6060	A5 - 11RD-24	1NO+1NC	Işıklı İkiz Buton 24V AC/DC		10	300	200.00

Ø 22mm BUTON SERİSİ AKSESUARLARI

	Sipariş Kodu	Ürün Kodu	Açıklama	Kutu Adet	Birim Fiyat TL / Ad.
	6101	A - 10	1NO Start Kontakt	250	32.00
	6102	A - 01	1NC Stop Kontakt	250	32.00
	6103	A - D2	BA9S Led Kontakt Yuvası (Buton için)	200	38.00
	6104	FC	Plastik Buton Rozeti	100	4.50
	6105	FD/60	60mm Acil Stop Etiketi	100	13.00
	6106	EC5-1	Acil Stop Butonu Koruma Kapağı	20	78.00
	6107	FH	Buton Koruma Kapağı	4	65.00
	6108	BK	Buton Koruma Kılıfı	100	10.00

BOŞ KUMANDA KUTULARI

	Sipariş Kodu	Ürün Kodu	Açıklama	Renk	Kutu Adet	Koli Adet	Birim Fiyat TL / Ad.
	6114	GBK - 1	1'li Boş Kumanda Kutusu	Sarı-Siyah	1	100	53.00
	6116	GBK - 2	2'li Boş Kumanda Kutusu	Sarı-Siyah	1	100	66.00
	6118	GBK - 3	3'lü Boş Kumanda Kutusu	Sarı-Siyah	1	100	85.00
	6120	GBK - 4	4'lü Boş Kumanda Kutusu	Sarı-Siyah	1	50	107.00
	6122	GBK - 5	5'li Boş Kumanda Kutusu	Sarı-Siyah	1	50	160.00
	6124	GBK - 6	6'lı Boş Kumanda Kutusu	Sarı-Siyah	1	50	160.00

KUTULU ACİL STOP BUTON

	Sipariş Kodu	Ürün Kodu	Kontakt	Açıklama	Renk	Kutu Adet	Koli Adet	Birim Fiyat TL / Ad.
	6125	LAY2 - KSE542	NC	1'li Mantar Acil Stop Buton	Sarı-Siyah	1	100	135.00

VİNÇ KUMANDALARI





VİNÇ KUMANDALAR

	Sipariş Kodu	Ürün Kodu	Açıklama	Kutu Adet	Koli Adet	Birim Fiyat USD / Ad.
	6701	VK - 2	Vinç Kumanda 2'li Tek Hızlı	1	72	5.80
	6702	VK - 4	Vinç Kumanda 4'li Tek Hızlı	1	48	7.50
	6703	VK - 6	Vinç Kumanda 6'li Tek Hızlı	1	42	10.00
	6704	VK - 8	Vinç Kumanda 8'li Tek Hızlı	1	36	13.00





ACİL STOPLU VİNÇ KUMANDALAR

	6705	VKB - 3	Vinç Kumanda 3'li Tek Hızlı	1	50	23.00
	6706	VKB - 5	Vinç Kumanda 5'li Tek Hızlı	1	40	32.00
	6707	VKB - 7	Vinç Kumanda 7'li Tek Hızlı	1	30	41.00
	6708	VKB - 9	Vinç Kumanda 9'li Tek Hızlı	1	20	50.00

Ø 22mm VOLTMETRE

	Sipariş Kodu	Ürün Kodu	Çap (mm)	Açıklama	Renk	Kutu Adet	Koli Adet	Birim Fiyat TL / Ad.
	6501	22 VS - K	22	24 - 550V Led'li Voltmetre	● Kırmızı	10	500	110.00
	6502	22 VS - Y	22	24 - 550V Led'li Voltmetre	● Yeşil	10	500	110.00
	6503	22 VS - S	22	24 - 550V Led'li Voltmetre	● Sarı	10	500	110.00
	6504	22 VS - M	22	24 - 550V Led'li Voltmetre	● Mavi	10	500	110.00
	6505	22 VS - B	22	24 - 550V Led'li Voltmetre	○ Beyaz	10	500	110.00

Ø 22mm AMPERMETRE

	Sipariş Kodu	Ürün Kodu	Çap (mm)	Açıklama	Renk	Kutu Adet	Koli Adet	Birim Fiyat TL / Ad.
	6511	22 - AS -K	22	0 - 100A Led'li Ampermetre Akım Trafolu	● Kırmızı	10	300	220.00
	6512	23 - AS -Y	22	0 - 100A Led'li Ampermetre Akım Trafolu	● Yeşil	10	300	220.00
	6513	24 - AS -S	22	0 - 100A Led'li Ampermetre Akım Trafolu	● Sarı	10	300	220.00
	6514	25 - AS - M	22	0 - 100A Led'li Ampermetre Akım Trafolu	● Mavi	10	300	220.00
	6515	26 - AS -B	22	0 - 100A Led'li Ampermetre Akım Trafolu	○ Beyaz	10	300	220.00

Ø 22mm LED'Lİ SİNYALLER



Sipariş Kodu	Ürün Kodu	Çap (mm)	Açıklama	Renk	Kutu Adet	Koli Adet	Birim Fiyat TL / Ad.
6601	22 - K	22	Led Sinyal 220V. AC-DC	● Kırmızı	10	500	29.00
6602	22 - Y	22		● Yeşil	10	500	29.00
6603	22 - S	22		● Sarı	10	500	29.00
6604	22 - M	22		● Mavi	10	500	29.00
6605	22 - B	22		○ Beyaz	10	500	35.00
6606	22 - 110V - K	22	Led Sinyal 110V. AC-DC	● Kırmızı	10	500	29.00
6607	22 - 110V - Y	22		● Yeşil	10	500	29.00
6608	22 - 110V - S	22		● Sarı	10	500	29.00
6609	22 - 110V - M	22		● Mavi	10	500	29.00
6610	22 - 110V - B	22		○ Beyaz	10	500	35.00
6611	22 - 24V - K	22	Led Sinyal 24V. AC-DC	● Kırmızı	10	500	29.00
6612	22 - 24V - Y	22		● Yeşil	10	500	29.00
6613	22 - 24V - S	22		● Sarı	10	500	29.00
6614	22 - 24V - M	22		● Mavi	10	500	29.00
6615	22 - 24V - B	22		○ Beyaz	10	500	35.00

Ø 16mm LED'Lİ SİNYALLER



Sipariş Kodu	Ürün Kodu	Çap (mm)	Açıklama	Renk	Kutu Adet	Koli Adet	Birim Fiyat TL / Ad.
6621	16 - K	16	Led Sinyal 220V. AC-DC	● Kırmızı	20	1.000	40.00
6622	16 - Y	16		● Yeşil	20	1.000	40.00
6623	16 - S	16		● Sarı	20	1.000	40.00
6624	16 - M	16		● Mavi	20	1.000	40.00
6625	16 - B	16		○ Beyaz	20	1.000	55.00
6626	16 - 110V - K	16	Led Sinyal 110V. AC-DC	● Kırmızı	20	1.000	40.00
6627	16 - 110V - Y	16		● Yeşil	20	1.000	40.00
6628	16 - 110V - S	16		● Sarı	20	1.000	40.00
6629	16 - 110V - M	16		● Mavi	20	1.000	40.00
6630	16 - 110V - B	16		○ Beyaz	20	1.000	55.00
6631	16 - 24V - K	16	Led Sinyal 24V. AC-DC	● Kırmızı	20	1.000	40.00
6632	16 - 24V - Y	16		● Yeşil	20	1.000	40.00
6633	16 - 24V - S	16		● Sarı	20	1.000	40.00
6634	16 - 24V - M	16		● Mavi	20	1.000	40.00
6635	16 - 24V - B	16		○ Beyaz	20	1.000	55.00

BA9S LED AMPULLER



Sipariş Kodu	Ürün Kodu	Açıklama	Renk	Kutu Adet	Koli Adet	Birim Fiyat TL / Ad.
6521	BA9SC - K		● Kırmızı	50	4.000	35.00
6522	BA9SC - Y		● Yeşil	50	4.000	35.00
6523	BA9SC - S	Led Ampul 220V. AC-DC	● Sarı	50	4.000	35.00
6524	BA9SC - M		● Mavi	50	4.000	35.00
6525	BA9SC - B		○ Beyaz	50	4.000	42.00
6526	BA9SC - 110V - K		● Kırmızı	50	4.000	35.00
6527	BA9SC - 110V - Y		● Yeşil	50	4.000	35.00
6528	BA9SC - 110V - S	Led Ampul 110V. AC-DC	● Sarı	50	4.000	35.00
6529	BA9SC - 110V - M		● Mavi	50	4.000	35.00
6530	BA9SC - 110V - B		○ Beyaz	50	4.000	42.00
6531	BA9SC - 24V - K		● Kırmızı	50	4.000	35.00
6532	BA9SC - 24V - Y		● Yeşil	50	4.000	35.00
6533	BA9SC - 24V - S	Led Ampul 24V. AC-DC	● Sarı	50	4.000	35.00
6534	BA9SC - 24V - M		● Mavi	50	4.000	35.00
6535	BA9SC - 24V - B		○ Beyaz	50	4.000	42.00

BUZZER'LAR

Ø 22mm LED'Lİ BUZZERLAR (90dB)



Sipariş Kodu	Ürün Kodu	Çap (mm)	Açıklama	Renk	Kutu Adet	Koli Adet	Birim Fiyat TL / Ad.
6640	22DS/MS	22	Sesli Led Flaşör İkazlı 220V. AC	● Kırmızı	10	500	115.00
6641	22DS/MS24	22	Sesli Led Flaşör İkazlı 24V. AC/DC	● Kırmızı	10	500	115.00

MOTORLU SİRENLER



Sipariş Kodu	Ürün Kodu	Açıklama	Kutu Adet	Koli Adet	Birim Fiyat TL / Ad.
6651	MS - 190	75mm Metal Gövde 220V. AC (110 - 130dB)	1	40	480.00
6652	MS - 190 - 24	75mm Metal Gövde 24V. DC (110 - 130dB)	1	40	480.00

PANO İÇİ TERMOSTATLAR

Çalışma Ömrü : 100.000 Açma Kapama
Ölçüler : 60x33x43
Ağırlık : 40 gr
Koruma Sınıfı : IP20



Sipariş Kodu	Ürün Kodu	Ürün Kodu	Açıklama ve Çalışma Sıcaklığı	Kutu Adet	Koli Adet	Birim Fiyat TL / Ad.
6682	KTO - 011	NC	Isıtma Termostatu (0 - 60°C)	1	300	210.00
6681	KTS - 011	NO	Soğutma Termostatu (0 - 60°C)	1	300	210.00

Ø 22mm POTANSİYOMETRE

	Birim Fiyat TL / Ad.	175.00
	Sipariş Kodu	6665
	Ürün Kodu	APT22 - 5K
	Çap (mm)	22
	Kutu Adet	10
	Koli Adet	500
	Açıklama	5K Potansiyometre Tek Turlu 220V. AC

	Birim Fiyat TL / Ad.	175.00
	Sipariş Kodu	6666
	Ürün Kodu	APT22 - 10K
	Çap (mm)	22
	Kutu Adet	10
	Koli Adet	500
	Açıklama	10K Potansiyometre Tek Turlu 220V. AC

AKS SERİSİ KAPI SWITCH



Sipariş Kodu	Ürün Kodu	Kontak	Açıklama	Kutu Adet	Koli Adet	Birim Fiyat TL / Ad.
6825	AKS - 10	NO	Açık Kontak Kapi Switch	50	500	50.00
6826	AKS - 01	NC	Kapalı Kontak Kapi Switch	50	500	55.00



SWITCH GRUBU

GLS - AZ - GMS Serisi



GLS SERİSİ LİMİT SWITCH

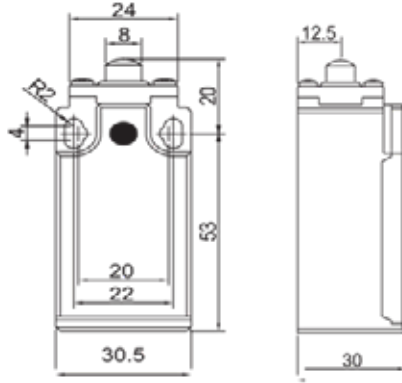

Birim Fiyat USD / Ad.	7.20 \$
Sipariş Kodu	6801
Ürün Kodu	GLS -101
Kutu Adet	10
Koli Adet	100
Açıklama	Kısa Dikey Metal Pim 1NO + 1NC

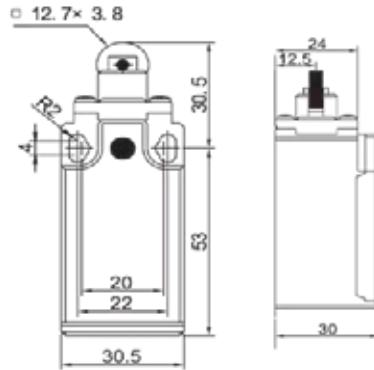

Birim Fiyat USD / Ad.	7.20 \$
Sipariş Kodu	6802
Ürün Kodu	GLS -103
Kutu Adet	10
Koli Adet	100
Açıklama	Dikey Metal Makaralı 1NO + 1NC



RESETLİ

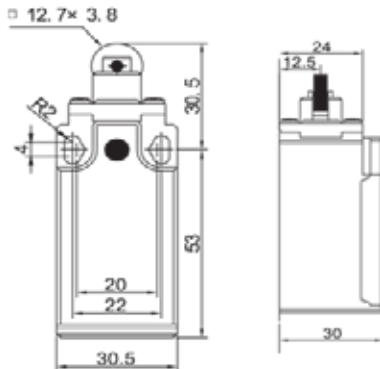

Birim Fiyat USD / Ad.	7.70 \$
Sipariş Kodu	6803
Ürün Kodu	GLS -103R
Kutu Adet	10
Koli Adet	100
Açıklama	Dikey Metal Makaralı Resetli 1NO + 1NC

GLS SERİSİ LİMİT SWITCH

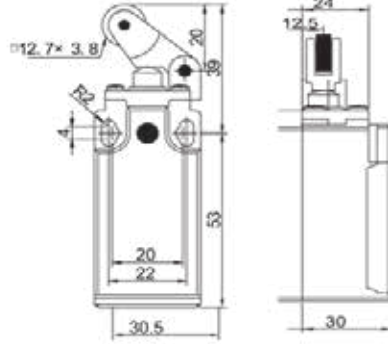

Birim Fiyat USD / Ad.	7.20 \$
Sipariş Kodu	6804
Ürün Kodu	GLS -111
Kutu Adet	10
Koli Adet	100
Açıklama	Açısal Metal Makaralı Tek Yön 1NO + 1NC

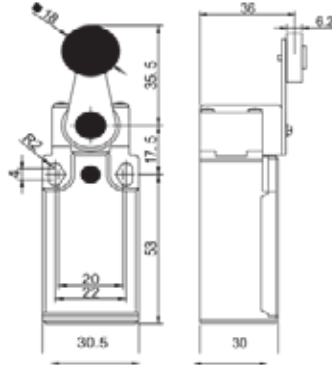

Birim Fiyat USD / Ad.	7.20 \$
Sipariş Kodu	6805
Ürün Kodu	GLS -121
Kutu Adet	10
Koli Adet	100
Açıklama	Dikey Metal Makaralı Çift Yön 1NO + 1NC

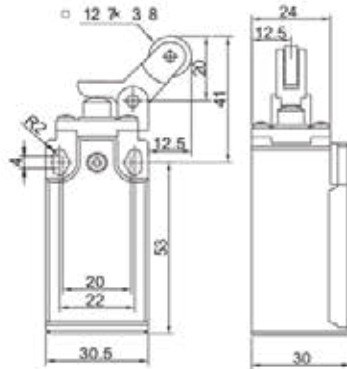

Birim Fiyat USD / Ad.	7.20 \$
Sipariş Kodu	6806
Ürün Kodu	GLS -127
Kutu Adet	10
KOLİ ADETİ	100
Açıklama	Ters Açısal Metal Makaralı Tek Yön 1NO + 1NC

GLS SERİSİ LİMİT SWITCH

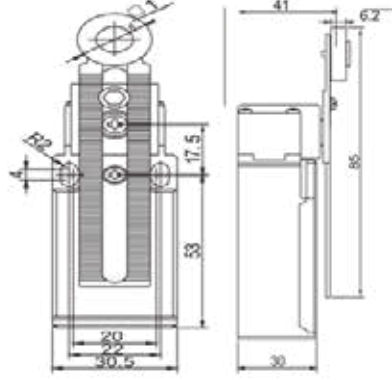

Birim Fiyat USD / Ad.	7.50 \$
Sipariş Kodu	6807
Ürün Kodu	GLS -131
Kutu Adet	10
Koli Adet	100
Açıklama	Ayarlanabilir Metal Makaralı Çift Yön 1NO + 1NC

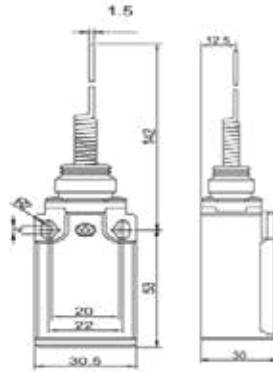

Birim Fiyat USD / Ad.	7.50 \$
Sipariş Kodu	6808
Ürün Kodu	GLS -161
Kutu Adet	10
Koli Adet	100
Açıklama	Çok Yönlü Spiral Tel Uç 1NO + 1NC

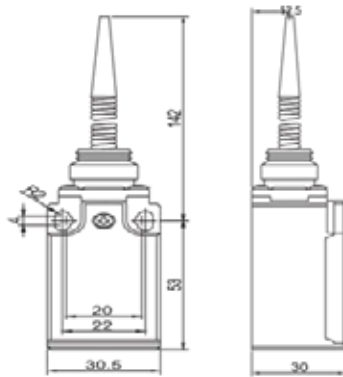

Birim Fiyat USD / Ad.	7.50 \$
Sipariş Kodu	6809
Ürün Kodu	GLS -171
Kutu Adet	10
Koli Adet	100
Açıklama	Çok Yönlü Spiral Plastik Uç 1NO + 1NC

GLS SERİSİ LİMİT SWITCH

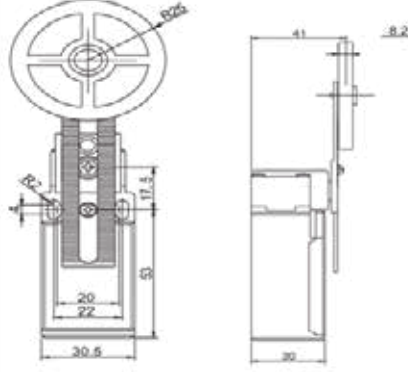

Birim Fiyat USD / Ad.	7.50 \$
Sipariş Kodu	6810
Ürün Kodu	GLS -191
Kutu Adet	1
Koli Adet	100
Açıklama	Ayarlanabilir Kauçuk Makara Çift Yön 1NO + 1NC

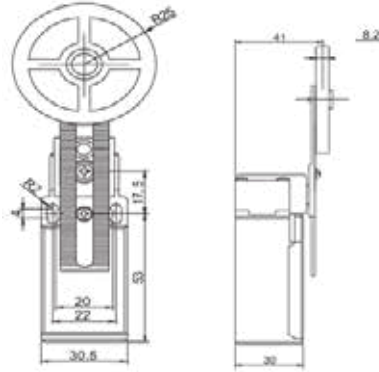

RESETLİ

Birim Fiyat USD / Ad.	9.50 \$
Sipariş Kodu	6800
Ürün Kodu	GLS -191R
Kutu Adet	1
Koli Adet	100
Açıklama	Ayarlanabilir Kauçuk Makara Çift Yön Resetli 1NO + 1NC



AZ SERİSİ MİKRO SWİTCH

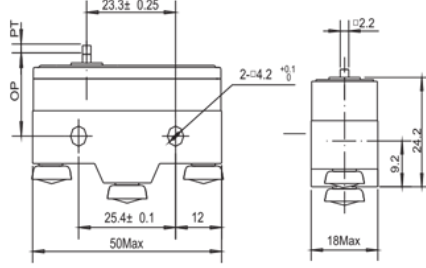

Birim Fiyat USD / Ad.	3.85 \$
Sipariş Kodu	6811
Ürün Kodu	AZ - 15G - B
Kutu Adet	20
Koli Adet	360
Açıklama	İnce Kısa Pimli 15A 1NO + 1NC

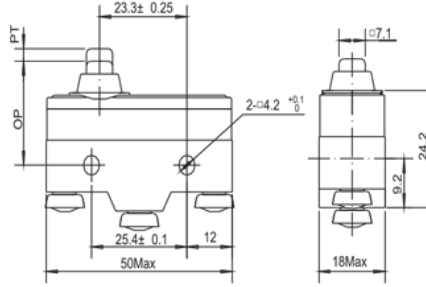

Birim Fiyat USD / Ad.	4.25 \$
Sipariş Kodu	6812
Ürün Kodu	AZ - 15GD - B
Kutu Adet	20
Koli Adet	360
Açıklama	Kalın Uzun Pimli 15A 1NO + 1NC

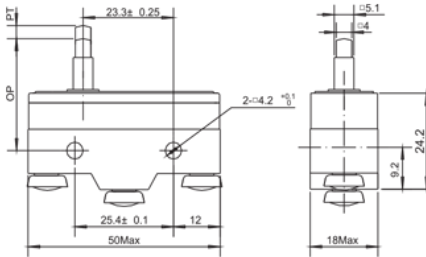

Birim Fiyat USD / Ad.	4.95 \$
Sipariş Kodu	6813
Ürün Kodu	AZ - 15GS - B
Kutu Adet	20
Koli Adet	360
Açıklama	İnce Uzun Pimli 15A 1NO + 1NC

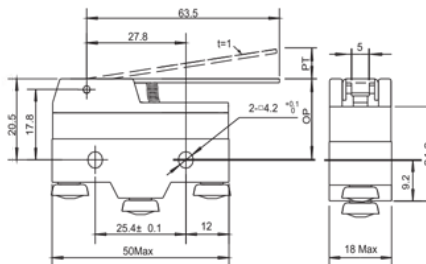

Birim Fiyat USD / Ad.	4.25 \$
Sipariş Kodu	6814
Ürün Kodu	AZ - 15GW - B
Kutu Adet	20
Koli Adet	360
Açıklama	Uzun Palet 15A 1NO + 1NC

AZ SERİSİ MİKRO SWITCH

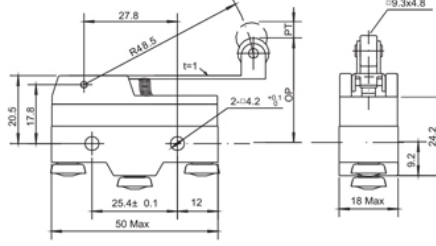

Birim Fiyat USD / Ad.	4.60 \$
Sipariş Kodu	6815
Ürün Kodu	AZ - 15GW2 - B
Kutu Adet	20
Koli Adet	360
Açıklama	Uzun Paletli Metal Makaralı 15A 1NO + 1NC

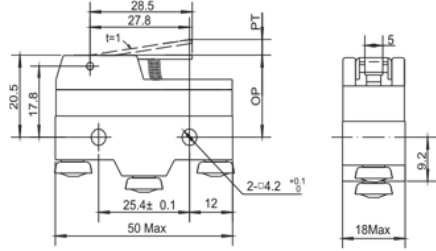

Birim Fiyat USD / Ad.	4.25 \$
Sipariş Kodu	6817
Ürün Kodu	AZ - 15GW21 - B
Kutu Adet	20
Koli Adet	360
Açıklama	Kısa Paletli 15A 1NO + 1NC

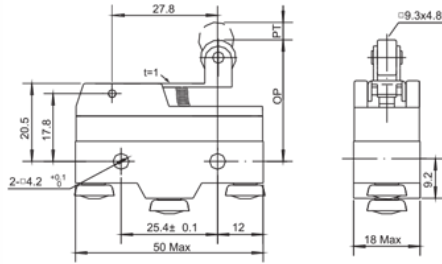

Birim Fiyat USD / Ad.	4.60 \$
Sipariş Kodu	6818
Ürün Kodu	AZ - 15GW22 - B
Kutu Adet	20
Koli Adet	360
Açıklama	Kısa Metal Makaralı 15A 1NO + 1NC

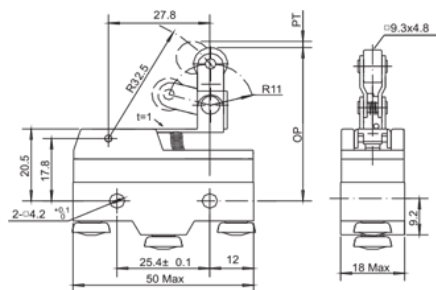

Birim Fiyat USD / Ad.	5.10 \$
Sipariş Kodu	6819
Ürün Kodu	AZ - 15GW2277 - B
Kutu Adet	20
Koli Adet	360
Açıklama	Tahrikli Metal Makaralı 15A 1NO + 1NC

AZ SERİSİ MİKRO SWİTÇ

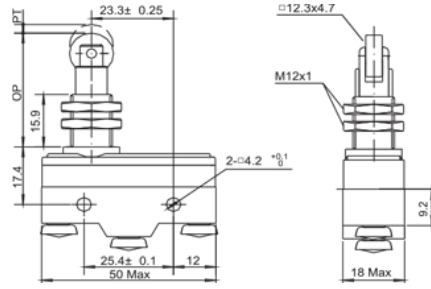

Birim Fiyat USD / Ad.	6.40 \$
Sipariş Kodu	6820
Ürün Kodu	AZ - 15GQ22 - B
Kutu Adet	20
Koli Adet	360
Açıklama	Dikey Metal Makaralı 15A 1NO + 1NC

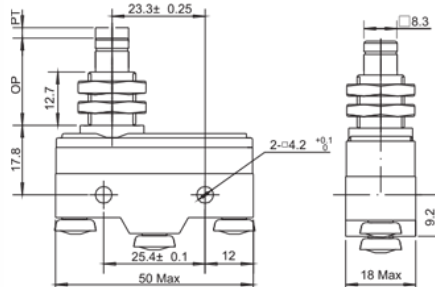

Birim Fiyat USD / Ad.	5.60 \$
Sipariş Kodu	6821
Ürün Kodu	AZ - 15GQ - B
Kutu Adet	20
Koli Adet	360
Açıklama	Kalın Kısa Metal Pimli 15A 1NO + 1NC

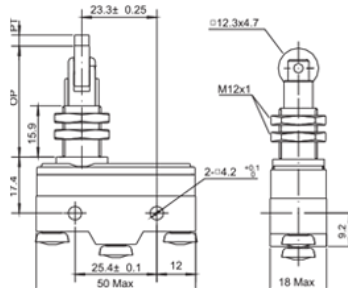

Birim Fiyat USD / Ad.	6.40 \$
Sipariş Kodu	6822
Ürün Kodu	AZ - 15GQ21 - B
Kutu Adet	20
Koli Adet	360
Açıklama	Yan Dik Metal Makaralı 15A 1NO + 1NC

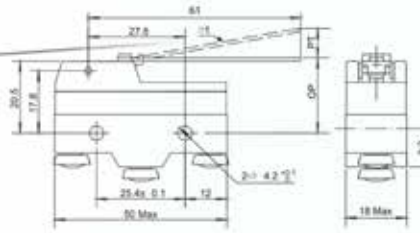

Birim Fiyat USD / Ad.	4.60 \$
Sipariş Kodu	6823
Ürün Kodu	AZ - 15HW24 - B
Kutu Adet	20
Koli Adet	360
Açıklama	Uzun Tel Palet 15A 1NO + 1NC

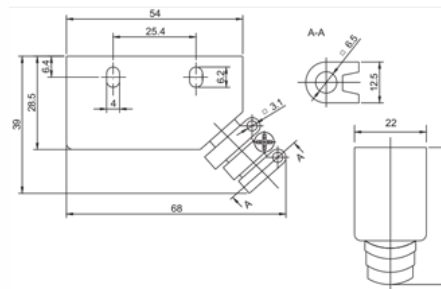

Birim Fiyat USD / Ad.	0.73 \$
Sipariş Kodu	6824
Ürün Kodu	XAP - Y
Kutu Adet	100
Koli Adet	1.000
Açıklama	Koruma Kabı

GMS SERİSİ MİKRO SWITCH



Birim Fiyat USD / Ad.	1.15 \$		
Sipariş Kodu	6830	Ürün Kodu	GMS - 100C
Kutu Adet	100	Koli Adet	1.800
Açıklama	10 Amper Plastik Pimli Mikro Switch		
Birim Fiyat USD / Ad.	1.22 \$		
Sipariş Kodu	6831	Ürün Kodu	GMS - 101C
Kutu Adet	100	Koli Adet	1.800
Açıklama	10 Amper Orta Kollu Mikro Switch		
Birim Fiyat USD / Ad.	1.22 \$		
Sipariş Kodu	6832	Ürün Kodu	GMS - 102C
Kutu Adet	100	Koli Adet	1.800
Açıklama	10 Amper Kısa Kollu Mikro Switch		
Birim Fiyat USD / Ad.	1.38 \$		
Sipariş Kodu	6833	Ürün Kodu	GMS - 103C
Kutu Adet	100	Koli Adet	1.800
Açıklama	10 Amper Uzun Kollu Metal Makaralı Mikro Switch		
Birim Fiyat USD / Ad.	1.38 \$		
Sipariş Kodu	6834	Ürün Kodu	GMS - 104C
Kutu Adet	100	Koli Adet	1.800
Açıklama	10 Amper Kısa Kollu Metal Makaralı Mikro Switch		
Birim Fiyat USD / Ad.	1.38 \$		
Sipariş Kodu	6835	Ürün Kodu	GMS - 105C
Kutu Adet	100	Koli Adet	1.800
Açıklama	10 Amper Uzun Kollu Mikro Switch		
Birim Fiyat USD / Ad.	1.38 \$		
Sipariş Kodu	6836	Ürün Kodu	GMS - 106C
Kutu Adet	100	Koli Adet	1.800
Açıklama	10 Amper Kıvrık Kollu Mikro Switch		

AYAK PEDALLARI

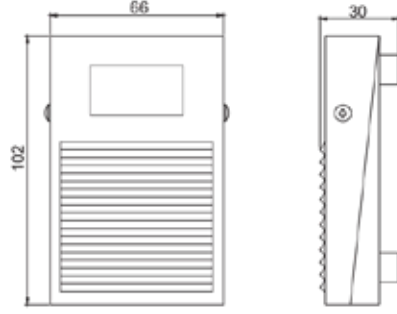

Birim Fiyat USD / Ad.	8.50 \$
Sipariş Kodu	6901
Ürün Kodu	AP - 1
Kutu Adet	1
Koli Adet	60
Açıklama	Metal Döküm Pedal 2mt Kablolu

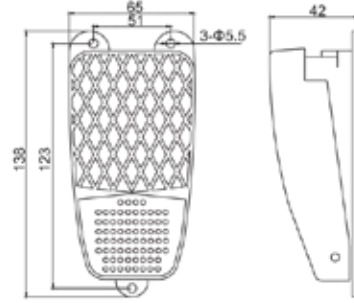

Birim Fiyat USD / Ad.	12.00 \$
Sipariş Kodu	6902
Ürün Kodu	AP - 2
Kutu Adet	1
Koli Adet	60
Açıklama	Alüminyum Döküm Pedal 1mt Kablolu

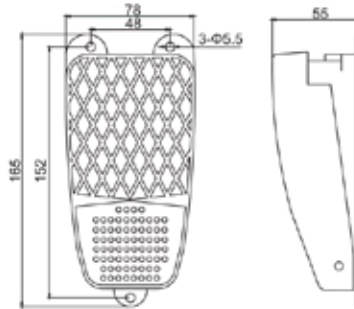

Birim Fiyat USD / Ad.	15.50 \$
Sipariş Kodu	6903
Ürün Kodu	AP - 3
Kutu Adet	1
Koli Adet	40
Açıklama	Alüminyum Döküm Pedal 1mt Kablolu

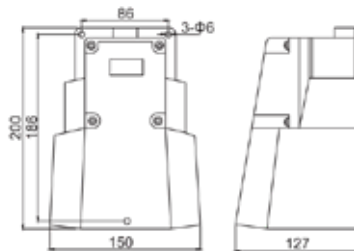

Birim Fiyat USD / Ad.	38.50 \$
Sipariş Kodu	6904
Ürün Kodu	AP - 9
Kutu Adet	1
Koli Adet	12
Açıklama	Metal Döküm Pedal



GÜVEN

ELEKTRİK ELEKTRONİK LTD. ŞTİ.

GWEST®

WWOER®

Başarılar Karşılıklı **Güven'e Bağlıdır...**

MERKEZ:

İkitelli Organize Sanayi Bölgesi
Mutsan Sanayi Sitesi M12 Blok No: 52-54
Başakşehir / İstanbul
Tel: 0212 485 05 40
Fax: 0212 486 05 61

İMALAT:

İkitelli Organize Sanayi Bölgesi
Mutsan Sanayi Sitesi M5 Blok No: 2/12
Başakşehir / İstanbul
Tel: 0212 361 69 61
Fax: 0212 361 69 63

www.guvenelektrik.com.tr